

PANELPIEDRA®
S I N C E 1 9 7 4

COLECCIÓN ARQUITEK + CATÁLOGO GENERAL 2023



P



ARQUITEK

Decorative Panels

Nuestra Empresa / Our Company	2-3
Nuestras Instalaciones / Facilities	4-5
Calidades / Qualities	6-7
Ventajas / Advantages	8
Sostenibilidad / Sustainability	8-9
Productos Arquitek Collection	14-113
Slim	
Milo	
Icon	
Spirit	
Arko	
Alma	
Modus	
Neos	
Scalon	
Loun	
Inner	
Rinn	
Blom	
Vita	
Perfiles	
Información Técnica / Technical Information	114
Garantía / Warranty	114
Condiciones de Venta / Sales Terms	115

Nuestra Empresa Our Company

PANELPIEDRA®
en el mundo
in the world

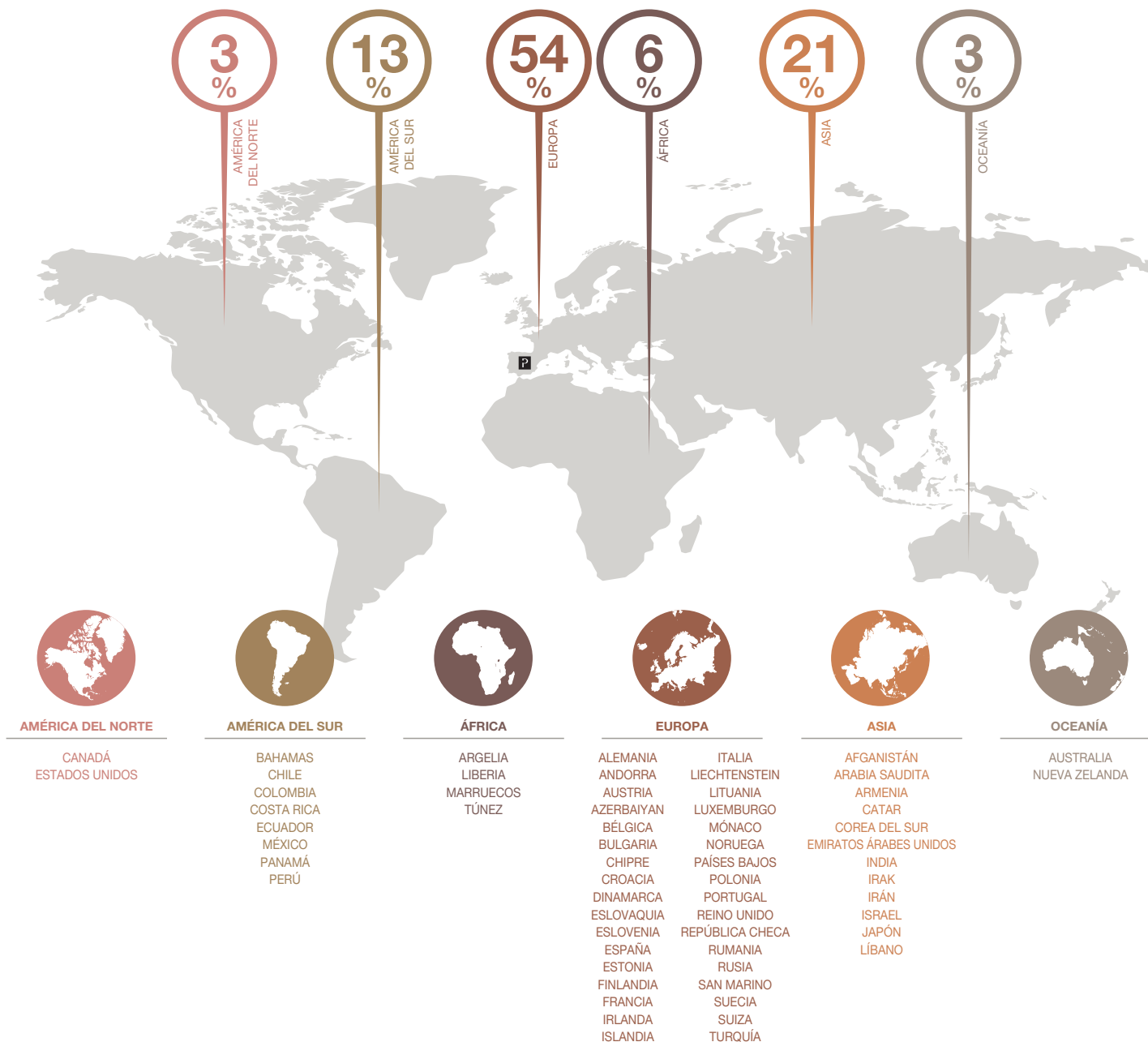

En sus 50 años de trayectoria Paneles Decorativos Panel Piedra ha centrado sus esfuerzos en ofrecer un producto de calidad y diseño claramente orientado a satisfacer las necesidades del cliente. Gracias al esfuerzo de todos estos años y a una acertada gestión empresarial, PANELPIEDRA® está presente en más de 60 países. Actualmente, su misión es crear espacios que contribuyan al bienestar a través del diseño, la funcionalidad y las tecnologías revestimiento.

Su estrategia está fuertemente marcada por la innovación dirigida tanto al producto como a la gestión de la empresa. Su objetivo es seguir imprimiendo un alto valor añadido que le permita la diferenciación con la competencia en los distintos mercados, y contribuir a mejorar la calidad de vida de sus clientes. La historia de esta empresa es la de la superación, el esfuerzo, la confianza y el trabajo en equipo. En todos estos años ha ido evolucionando paso a paso hasta llegar al punto de liderazgo que hoy ostenta PANELPIEDRA®.

In its 50 years of trajectory Paneles Decorativos Panel Piedra has always focused its efforts on offering a quality product and design, clearly oriented to satisfy customer needs. Thanks to the efforts of all these years and successful business management, PANELPIEDRA® is available in more than 60 countries. Currently, its mission is to create spaces that contribute to well-being through design, functionality and cladding technologies.

Its strategy is strongly marked by innovation directed both to the product and to the management of the company. Its objective is to continue to manufacture a high added value that allows it to differentiate itself from the competition in different markets and to contribute to improving the quality of life of its customers. The history of this company is one of fortuitous, effort, trust and teamwork. In all these years it has evolved step by step to reach the point of leadership that PANELPIEDRA® holds today.



PANELPIEDRA® dispone de un gran centro de fabricación en Tudela, Navarra, España. Con modernas y preparadas instalaciones de 170.000 m².

PANELPIEDRA® have a large manufacturing center in Tudela, Navarra, Spain With modern and prepared facilities of 170.000 m².

PANELES DECORATIVOS
PANELPIEDRA S.L.
Polígono Industrial Municipa
Vial Transversal, 2
31500 TUDELA (NAVARRA) SPAIN
T. +34 941 18 10 91
www.panelpiedra.com



Nuestras Instalaciones Facilities

OFICINAS

2.000 m2 de modernas oficinas y espacio expositivo, con una división perfectamente departamentada para ofrecer la mejor atención a los 52 países donde tenemos presencia comercial.

OFFICES

2.000 Sqm of offices and Showroom in order to offer the best possible customer service to all our clients, spread across 52 countries.

EXPOSICIÓN

Más de 1.000 m² destinados a nuestro showroom, con paneles de revestimientos y de mobiliario de baño.

EXHIBITION

With more than 1.000 m² destined to the exhibition of our cladding tiles and bathroom furniture products.

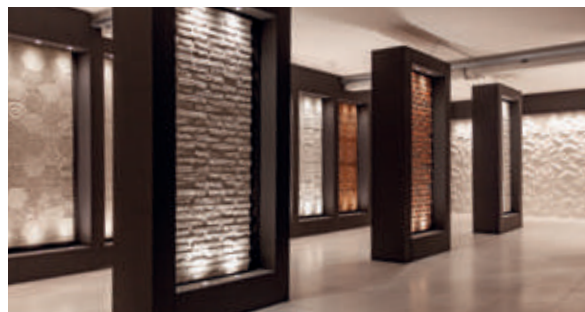

LAB E INGENIERÍA

Todos nuestros productos y materiales pasan un exhaustivo control de calidad en nuestros laboratorios, todo ello es precedido por una amplia labor de investigación y desarrollo llevada a cabo por el Departamento de Ingeniería, donde se trabaja para alcanzar los estándares de calidad e innovación que caracterizan nuestra marca PANELPIEDRA®

LAB AND ENGINEERING

All our products and materials pass an exhaustive quality control in our laboratories, all this is preceded by extensive research and development carried out by the Engineering Department, where we work to achieve the quality and innovation standards that characterize our PANELPIEDRA® brand.



PRODUCCIÓN

Miles de metros cuadrados de industria, dedicados a la fabricación de paneles decorativos para interior y exterior, mobiliario de baño, platos de ducha y lavabos (solid surface). Con zonas de modelado, de mezclas, de producción, de acabados, de secado y de inspección de calidad. **Todo preparado para que nuestro proceso de producción sea eficaz y de alta calidad.**

PRODUCTION

Thousands of sqm of manufacturing capacity with different departments for moulding, mixing, manufacturing, finishing, drying and quality inspection. **With the purpose of producing our products (wall covering panels for interior and exterior, bathroom furniture, shower trays, solid surface).**



ZONA DE EMBALAJE Y ALMACÉN

Una gran organización de nuestros productos, tanto en el embalaje como en el almacenaje, hacen que nuestros pedidos tengan un seguimiento continuo de calidad hasta su entrega.

PACKING & STORAGE AREA

A well organised packing and storage area in order to have a great follow up of clients' orders and keepup the high quality until delivery.



Calidades Qualities

Nuestra dedicación constante a la investigación tecnológica nos ha permitido desarrollar un producto perfecto y vanguardista en un campo en constante evolución, como es el mundo de la decoración y el diseño.

Ofrecemos las mejores soluciones estéticas para las últimas tendencias en diseño e interiorismo, cada vez más iconoclasta en la combinación de formas, colores y materiales.

Nuestros sistemas de fabricación patentados nos permiten una reproducción fiel de texturas y tonos de piedras, ladrillos, cementos y maderas, pero además la facilidad de instalación, resistencia y calidad convierten a nuestro producto en uno de los más demandados por los profesionales del sector.

La utilización de los productos PANELPIEDRA® permite crear ambientes que combinan elegancia, diseño y calidad.

Our ongoing commitment to technological research allowed us to develop a cutting edge product within a constantly evolving industry, as it is the world of decoration and design.

We offer the best aesthetic solutions for the latest trends in interior design and, increasingly iconoclastic combination of shapes, colors and materials.

Our patented manufacturing systems allow us to faithfully reproduce textures and colors of stones, bricks cement and woods. The easy installation, strength and high quality of our products, makes them highly demanded by professionals.

The use of PANELPIEDRA® products allow customers to create atmospheres that combine elegance, quality and design.

PR

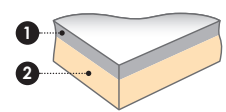



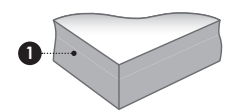

1. Polvo de mármol (Piedra) /
Crushed marble stone
2. Poliuretano alta densidad /
High density injected polyurethane

ECO
LUXER



1. Polvo de mármol (Piedra) - Panel Aligerado /
Crushed marble stone - Lightened Panel

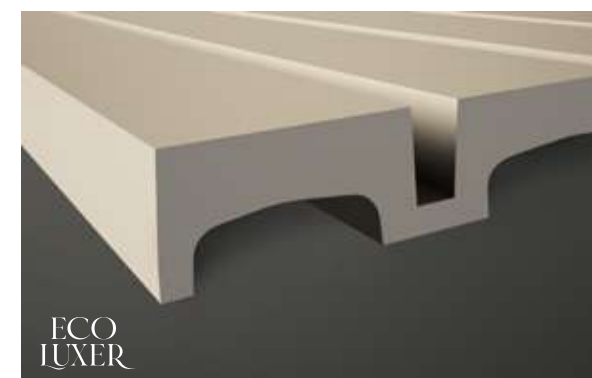
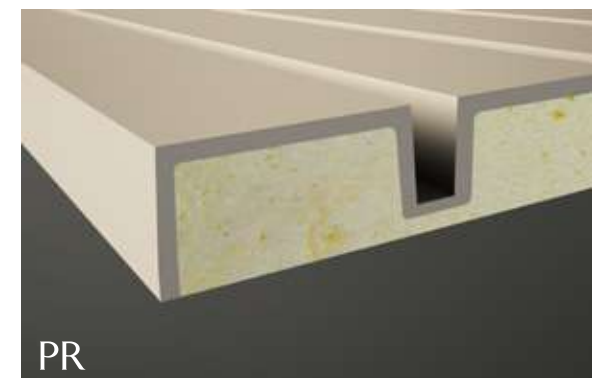

Paneles compuestos en un **75% por material reciclable** sobrantes de canteras.

Panels composed of **75% recyclable material** from quarries.

PR

Panel de poliuretano con piedra.

Panel compuesto por una capa de 4 mm. (aprox.) de polvo de mármol (piedra) y una capa de inyección de poliuretano de alta densidad.

Todo ello hace que sea muy resistente a todo tipo de inclemencias climatológicas (lluvia, sol, heladas, niebla, salina, etc.) Es apto para su colocación en interior y en exterior. Excelentes propiedades saliente térmicas, acústicas y anti-humedad.

Polyurethane and stone panel.

Panel composed of a layer of approximately 4 mm of crushed marble stone and a layer of high density injected polyurethane.

These components makes it very resistant to all kinds of weather conditions (rain, sun, frost, fog, salt, etc.).

Suitable for indoors and outdoors installations. Excellent thermal, acoustic and anti-humidity characteristics.

ECO
LUXER

Panel EcoLuxer®.

Panel compuesto de polvo de mármol (piedra) aligerado.

EcoLuxer® es un producto innovador para revestimientos de todo tipo de paredes, muros y techos, compuesto con más de 16 tipos de cargas, minerales y químicas (piedra, mármol, sílices, silicatos, etc.) que lo hacen muy resistentes al exterior, al fuego y todo tipo de inclemencias climatológicas en el tiempo, como a su vez gran resistencia a la abrasión y productos químicos. También goza de una gran cualidad que es su bajo peso y su alto volumen, que todo ello hace que sea muy fácil su colocación. Es muy apto para lugares públicos de gran tránsito de personas, fachadas y grandes construcciones, lugares con mucha humedad, saunas, etc.

Excelentes propiedades ignífugas, hidrófugas, su inalterabilidad al choque térmico y a sus ciclos de hielo y deshielo, su nulo porcentaje de absorción de agua garantiza su completa estanqueidad, su alta resistencia a la mayoría de productos químicos, junto con su mínimo desgaste por abrasión, hacen que el producto EcoLuxer® sea un material de alta calidad extra.

EcoLuxer® Panel.

Panel composed of crushed marble stone lighter.

EcoLuxer® is a highly innovative panel for coating all types of walls and ceilings. It is made out of more than 16 types of mineral and chemical charges (ie: stone, marble, silica, silicates, etc.). This composition makes the panel suitable to exteriors, resistant to fire and all kind of weather. Also, it has great resistance to abrasion and chemicals. Its low weight and large size makes the installation very quick and easy. Suitable for public places and areas of high traffic of people, facades, large buildings, places with high humidity (ie: saunas), etc.

Excellent fire retardant, water repellent, resistant to heat, freeze and defrost. Its zero percent water absorption ensures a complete sealing. High resistance to most chemicals products and low abrasive wear. All these characteristics make HD® panel a extra high quality material.

Ventajas Advantages

- El panel más ligero del mercado.
- Instalación más fácil y sencilla.
- Paneles de colocación rápida.
- Importante ahorro en costes.
- Acabado perfecto.
- No necesita mantenimiento.
- Excelente aislamiento acústico.
- Buen aislamiento térmico y anti-humedad.
- Excelentes propiedades ignífugas.
- Excelente repelencia al agua.
- No se altera con el calor, el frío o la congelación.
- Material impermeable.
- Mínima abrasión.
- Alta resistencia a la mayoría de los productos químicos.
- Elegantes combinaciones de materiales y diseños.
- Facilidad de transporte y manejo

- The lightest panel in the market.
- Easy and simple installation.
- Quick installation system.
- Cost savings in labor.
- Perfect finish.
- Does not require maintenance
- Excellent soundproof qualities.
- Good thermal insulation and anti-humidity.
- Excellent flame retardant properties.
- Excellent water-repellent.
- No mutation to heat, freeze and defrost.
- Not permeable.
- Minimum abrasion.
- High resistance to most chemicals.
- Elegant combinations of materials and designs.
- Ease of transport and handling.



Sostenibilidad Sustainability

POR UNA MEJOR CALIDAD DE VIDA Y CONSERVACIÓN DEL MEDIO AMBIENTE.

En Paneles Decorativos PanelPiedra® sabemos que siempre debemos estar en continua evolución, mejorando la calidad de vida y conservando la naturaleza y el medio ambiente.

Nos centramos en aumentar el impacto positivo de nuestros paneles, fabricando con un 75% de materiales reciclables, polvo de mármol y restos de canteras. Nos comprometemos a mejorar continuamente la sostenibilidad de nuestra empresa.

La protección de la naturaleza y la mejora de la calidad de vida de las personas es el impulso que nos lleva a seguir investigando y mejorando.





FOR A BETTER QUALITY OF LIFE AND ENVIRONMENTAL CONSERVATION.

At PanelPiedra® Decorative Panels we know that we must always be in continuous evolution, improving the quality of life and conserving nature and the environment.

We focus on increasing the positive impact of our panels, manufacturing with 75% recyclable materials, marble dust and quarry waste. We are committed to continuously improve the sustainability of our company.

The protection of nature and the improvement of people's quality of life is the driving force behind our continuous research and improvement.

1. NUESTRAS RESINAS

EN NUESTRAS RESINAS UTILIZAMOS MATERIALES RECICLADOS DE BOTELLAS DE PLÁSTICO PET.

En Paneles Decorativos PanelPiedra® utilizamos resinas de poliéster y poliuretano con una cantidad muy elevada de **botellas de plástico recicladas.**

Cada metro cuadrado de nuestras resinas contiene al menos 1/3 de botellas de plástico recicladas.



1. OUR RESINS

IN OUR RESINS WE USE RECYCLE MATERIALS SUCHAS PLASTIC PET BOTTLES.

In Paneles Decorativos PanelPiedra® we use polyester and polyurethane resins with a very high quantity of **recycled plastic bottles.**

Each square meter of our resins contains at least 1/3 recycled plastic bottles

2. DESARROLLO SOSTENIBLE

Nuestras instalaciones disponen de depuradoras y procesos manuales para evitar el consumo excesivo de agua.

Nuestra materia prima consiste en un 75% de material reciclable, polvo de mármol y restos de canteras. Nos preocupa la contaminación y la incidencia de residuos como el plástico, por lo que utilizamos cartón reciclable en nuestros envases y así contribuir a la protección de la tierra y los océanos, ya que la biodiversidad marina es vital para la salud de las personas y de nuestro planeta.

Queremos conservar la naturaleza, adaptando todos los procesos de fabricación, para minimizar el impacto de nuestra actividad en el medio ambiente.

Intentamos generar los mínimos residuos posibles optimizando el uso de las materias primas. Los grosores de los paneles están cuidadosamente estudiados para evitar dimensiones innecesarias, minimizando los residuos sin afectar a su diseño ni calidad.

Nuestros productos están fabricados para una gran durabilidad, pueden ser repintados, esto permite reciclar el propio producto y pueden ser retirados y reinstalados en otros espacios por lo tanto es un producto reutilizable.



2. SUSTAINABLE DEVELOPMENT

Our facilities are equipped with purifiers and manual processes to avoid excessive water consumption.

Our raw material consists of 75% recyclable material, marble dust and quarry waste. We are concerned about pollution and the incidence of waste such as plastic, so we use recyclable cardboard in our packaging and thus contribute to the protection of land and oceans, as marine biodiversity is vital for the health of people and our planet.

We want to conserve nature by adapting all our manufacturing processes to minimise the impact of our activity on the environment.

We try to generate as little waste as possible by optimising the use of raw materials. The thicknesses of the panels are carefully studied to avoid unnecessary dimensions, minimising waste without affecting their design and quality.

Our products are manufactured for durability, they can be repainted, this allows the product itself to be recycled and they can be removed and reinstalled in other spaces, therefore it is a reusable product.



3. MATERIA PRIMA

En Paneles Decorativos PanelPiedra® estamos comprometidos con la continua mejora sostenible de nuestros productos, innovando en la seguridad de cada uno de los procesos.

El poliuretano, como nuestra materia prima, posee una serie de características que confieren a nuestros productos propiedades colaborativas con el medio ambiente.

3. RAW MATERIAL

At PanelPiedra® Decorative Panels we are committed to the continuous sustainable improvement of our products, innovating in the safety of each of our processes.

Polyurethane, as our raw material, has a series of characteristics that give our products environmentally friendly properties.



4. REDUCCIÓN DE CONSUMO DE ENERGÍA

El poliuretano es un eficaz aislante térmico, proporcionando además aislamiento acústico. Los paneles decorativos de PanelPiedra® cuentan con el certificado de Aislamiento Térmico según la normativa UNE.

Como eficaces aislantes, mejoran la eficiencia energética de los edificios y reducen la necesidad de calefacción y refrigeración, reduciendo así las emisiones de carbono.

Las Declaraciones Ambientales de Producto (DAP) proporcionan información cuantitativa sobre los impactos ambientales de un producto a lo largo de su vida útil. La Voz Europea del Poliuretano (PU Europe) ha llevado a cabo un análisis ambiental y económico del ciclo de vida del poliuretano como aislante en edificios de consumo de energía casi nulo en el que se determina que el poliuretano es una solución material altamente eficiente dado su bajo coste del ciclo de vida.



4. REDUCTION OF ENERGY CONSUMPTION

Polyurethane is an effective thermal insulator, also providing noise insulation. The decorative panels of PanelPiedra® have the certificate of Thermal Insulation according to the regulations UNE.

As effective insulators, they improve the energy efficiency of buildings and reduce the need for heating and cooling, thereby reducing carbon emissions.

Environmental Product Declarations (EPDs) provide quantitative information on the environmental impacts of a product throughout its life. The European Voice of the Polyurethane (PU Europe) has carried out an environmental and economic life cycle analysis of polyurethane as an insulator in nearly zero energy buildings where polyurethane is determined as a highly efficient material solution given its low life cycle cost.

5. REVESTIMIENTO IGNÍFUGO

Por su naturaleza, el poliuretano no genera gases ni humos asfixiantes y no es tóxico en contacto con el fuego, aumentando así la protección de personas y bienes.

Al mismo tiempo, los Paneles Decorativos PanelPiedra® están fabricados con un recubrimiento ignífugo acreditado según las normas UNE, que establece que los paneles no arden, y aguantan hasta 80° de temperatura hasta que comienzan a deformarse de forma cóncava.

Gracias a años de intensa investigación, todos nuestros productos cumplen con la normativa internacional en materia de seguridad contra incendios.

5. FLAME RETARDANT COATING

By its nature, polyurethane does not generate gases or asphyxiating fumes and is not toxic when it comes into contact with fire, thus increasing the protection of people and property.

At the same time, PanelPiedra® decorative panels are manufactured with a fire proof coating accredited by the certificate according to the UNE, which states that the panels do not burn, and hold up to 80° of temperature until they begin to deform concavely.

Thanks to years of intensive research, all our products comply with international regulations in fire safety agreements, in the EU and in Russia, USA, Australia and New Zealand.



6. REDUCCIÓN DE LA HUELLA DE CARBONO

Nuestro compromiso con el medioambiente para reducir la huella de carbono es total. Desarrollamos un avanzado plan de acción climática midiendo la huella de carbono de los últimos años lo que nos permitirá reducir, e incluso neutralizar, los impactos generados por nuestra actividad comercial.

Las emisiones inevitables de gases de efecto invernadero (huella de carbono cuya reducción no es viable) serán compensadas a través de la adquisición de créditos de carbono. De este modo, en PanelPiedra® nos comprometemos a convertirnos en una empresa 100% Neutra en Carbono en los próximos años.

6. CARBON FOOTPRINT REDUCTION

Our commitment to the environment to reduce our carbon footprint is total. We have developed an advanced climate action plan by measuring our carbon footprint over the last few years, which will enable us to reduce and even neutralise the impacts generated by our business activity.

Unavoidable greenhouse gas emissions (carbon footprint whose reduction is not feasible) will be offset through the acquisition of carbon credits, thus, at PanelPiedra® we are committed to becoming a 100% Carbon Neutral company in the coming years.



A R

Q U I

T E K



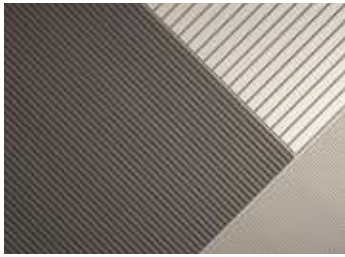

SLIM 18



MILO 28



ICON 34



SPIRIT 42



ARKO 48



ALMA 56



MODUS 62



NEOS 70



SCALON 76



LOUN 84



INNER 92



RINN 98



BLOM 102



VITA 106



PERFILES 110

* Especificaciones para los ACABADOS de COLORES 16-17





* Especificaciones para los ACABADOS de COLORES 16-17

Especificaciones para los Acabados de Colores

PR

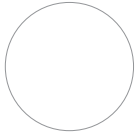
ECO
LUXER

Finished Colours

	Complementos necesarios para la instalación / Necessary materials for installation	Rendimiento Aproximado / Average Usage	PVP / Price
 <p>Ref.1 BLANCO WHITE</p>	<p>○ MSA-70 Masilla Juntas Blanco Roto</p> <p>○ PTX-20-400 Pintura Juntas Blanco Roto</p> <p>+Complementos opcionales para la instalación / Optional materials for installation</p> <p>○ MSA-3-280 Masilla de Pegado</p>	<p>1 Bote cada 2 paneles</p> <p>1 Bote cada 8 paneles</p> <p>1 Bote cada 4 paneles</p>	<p>-</p> <p>-</p> <p>-</p>
 <p>Ref.15 HUESO BONE</p>	<p>○ MSA-70 Masilla Juntas Blanco Roto</p> <p>● PTX-101-400 Pintura Juntas Hueso Acabado Liso</p> <p>+Complementos opcionales para la instalación / Optional materials for installation</p> <p>○ MSA-3-280 Masilla de Pegado</p>	<p>1 Bote cada 2 paneles</p> <p>1 Bote cada 8 paneles</p> <p>1 Bote cada 4 paneles</p>	<p>-</p> <p>-</p> <p>-</p>
 <p>Ref.2 CREMA CREAM</p>	<p>○ MSA-70 Masilla Juntas Blanco Roto</p> <p>● PTX-93-400 Pintura Juntas Crema Acabado Liso</p> <p>+Complementos opcionales para la instalación / Optional materials for installation</p> <p>○ MSA-3-280 Masilla de Pegado</p>	<p>1 Bote cada 2 paneles</p> <p>1 Bote cada 8 paneles</p> <p>1 Bote cada 4 paneles</p>	<p>-</p> <p>-</p> <p>-</p>
 <p>Ref.3 CEMENTO CONCRETE</p>	<p>○ MSA-70 Masilla Juntas Blanco Roto</p> <p>● PTX-94-400 Pintura Juntas Cemento Liso</p> <p>+Complementos opcionales para la instalación / Optional materials for installation</p> <p>○ MSA-3-280 Masilla de Pegado</p>	<p>1 Bote cada 2 paneles</p> <p>1 Bote cada 8 paneles</p> <p>1 Bote cada 4 paneles</p>	<p>-</p> <p>-</p> <p>-</p>
 <p>Ref.4 ARENA SAND</p>	<p>○ MSA-70 Masilla Juntas Blanco Roto</p> <p>● PTX-95-400 Pintura Juntas Arena Acabado Liso</p> <p>+Complementos opcionales para la instalación / Optional materials for installation</p> <p>○ MSA-3-280 Masilla de Pegado</p>	<p>1 Bote cada 2 paneles</p> <p>1 Bote cada 8 paneles</p> <p>1 Bote cada 4 paneles</p>	<p>-</p> <p>-</p> <p>-</p>
 <p>Ref.5 CAMEL CAMEL</p>	<p>○ MSA-70 Masilla Juntas Blanco Roto</p> <p>● PTX-96-400 Pintura Juntas Camel Acabado Liso</p> <p>+Complementos opcionales para la instalación / Optional materials for installation</p> <p>○ MSA-3-280 Masilla de Pegado</p>	<p>1 Bote cada 2 paneles</p> <p>1 Bote cada 8 paneles</p> <p>1 Bote cada 4 paneles</p>	<p>-</p> <p>-</p> <p>-</p>

 <p>Ref. 16 TABACO TOBACCO</p>	<p>Complementos necesarios para la instalación / Necessary materials for installation</p> <ul style="list-style-type: none"> ○ MSA-70 Masilla Juntas Blanco Roto ● PTX-102-400 Pintura Juntas Tabaco Acabado Liso <p>+Complementos opcionales para la instalación / Optional materials for installation</p> <ul style="list-style-type: none"> ○ MSA-3-280 Masilla de Pegado 	<p>Rendimiento Aproximado / Average Usage</p> <p>1 Bote cada 2 paneles 1 Bote cada 8 paneles</p> <p>1 Bote cada 4 paneles</p>	<p>PVP / Price</p> <p>- - -</p>
 <p>Ref. 6 PLOMO LEAD</p>	<p>Complementos necesarios para la instalación / Necessary materials for installation</p> <ul style="list-style-type: none"> ○ MSA-70 Masilla Juntas Blanco Roto ● PTX-97-400 Pintura Juntas Plomo Acabado Liso <p>+Complementos opcionales para la instalación / Optional materials for installation</p> <ul style="list-style-type: none"> ○ MSA-3-280 Masilla de Pegado 	<p>Rendimiento Aproximado / Average Usage</p> <p>1 Bote cada 2 paneles 1 Bote cada 8 paneles</p> <p>1 Bote cada 4 paneles</p>	<p>PVP / Price</p> <p>- - -</p>
 <p>Ref. 7 GRIS GREY</p>	<p>Complementos necesarios para la instalación / Necessary materials for installation</p> <ul style="list-style-type: none"> ○ MSA-70 Masilla Juntas Blanco Roto ● PTX-98-400 Pintura Juntas Gris Acabado Liso <p>+Complementos opcionales para la instalación / Optional materials for installation</p> <ul style="list-style-type: none"> ○ MSA-3-280 Masilla de Pegado 	<p>Rendimiento Aproximado / Average Usage</p> <p>1 Bote cada 2 paneles 1 Bote cada 8 paneles</p> <p>1 Bote cada 4 paneles</p>	<p>PVP / Price</p> <p>- - -</p>
 <p>Ref. 8 MARENGO MARENGO</p>	<p>Complementos necesarios para la instalación / Necessary materials for installation</p> <ul style="list-style-type: none"> ○ MSA-70 Masilla Juntas Blanco Roto ● PTX-99-400 Pintura Juntas Marengo Acabado Liso <p>+Complementos opcionales para la instalación / Optional materials for installation</p> <ul style="list-style-type: none"> ○ MSA-3-280 Masilla de Pegado 	<p>Rendimiento Aproximado / Average Usage</p> <p>1 Bote cada 2 paneles 1 Bote cada 8 paneles</p> <p>1 Bote cada 4 paneles</p>	<p>PVP / Price</p> <p>- - -</p>
 <p>Ref. 9 NEGRO BLACK</p>	<p>Complementos necesarios para la instalación / Necessary materials for installation</p> <ul style="list-style-type: none"> ○ MSA-70 Masilla Juntas Blanco Roto ● PTX-100-400 Pintura Juntas Negro Acabado Liso <p>+Complementos opcionales para la instalación / Optional materials for installation</p> <ul style="list-style-type: none"> ○ MSA-3-280 Masilla de Pegado 	<p>Rendimiento Aproximado / Average Usage</p> <p>1 Bote cada 2 paneles 1 Bote cada 8 paneles</p> <p>1 Bote cada 4 paneles</p>	<p>PVP / Price</p> <p>- - -</p>
 <p>IMITACIÓN CEMENTO IMITATION CONCRETE</p>	<p>Complementos necesarios para la instalación / Necessary materials for installation</p> <ul style="list-style-type: none"> ○ MSA-10 Masilla Juntas Beige Pizarra ● PTX-64-400 Pintura Juntas Cemento <p>+Complementos opcionales para la instalación / Optional materials for installation</p> <ul style="list-style-type: none"> ○ MSA-3-280 Masilla de Pegado 	<p>Rendimiento Aproximado / Average Usage</p> <p>1 Bote cada 2 paneles 1 Bote cada 8 paneles</p> <p>1 Bote cada 4 paneles</p>	<p>PVP / Price</p> <p>- - -</p>

SLIM



SLIM

Crea espacios arquitectónicos, modernos y minimalistas, que despuntarán por su gran sencillez y belleza.

It creates modern, minimalist architectural spaces that stand out for their simplicity and beauty.

ECO
LUXER

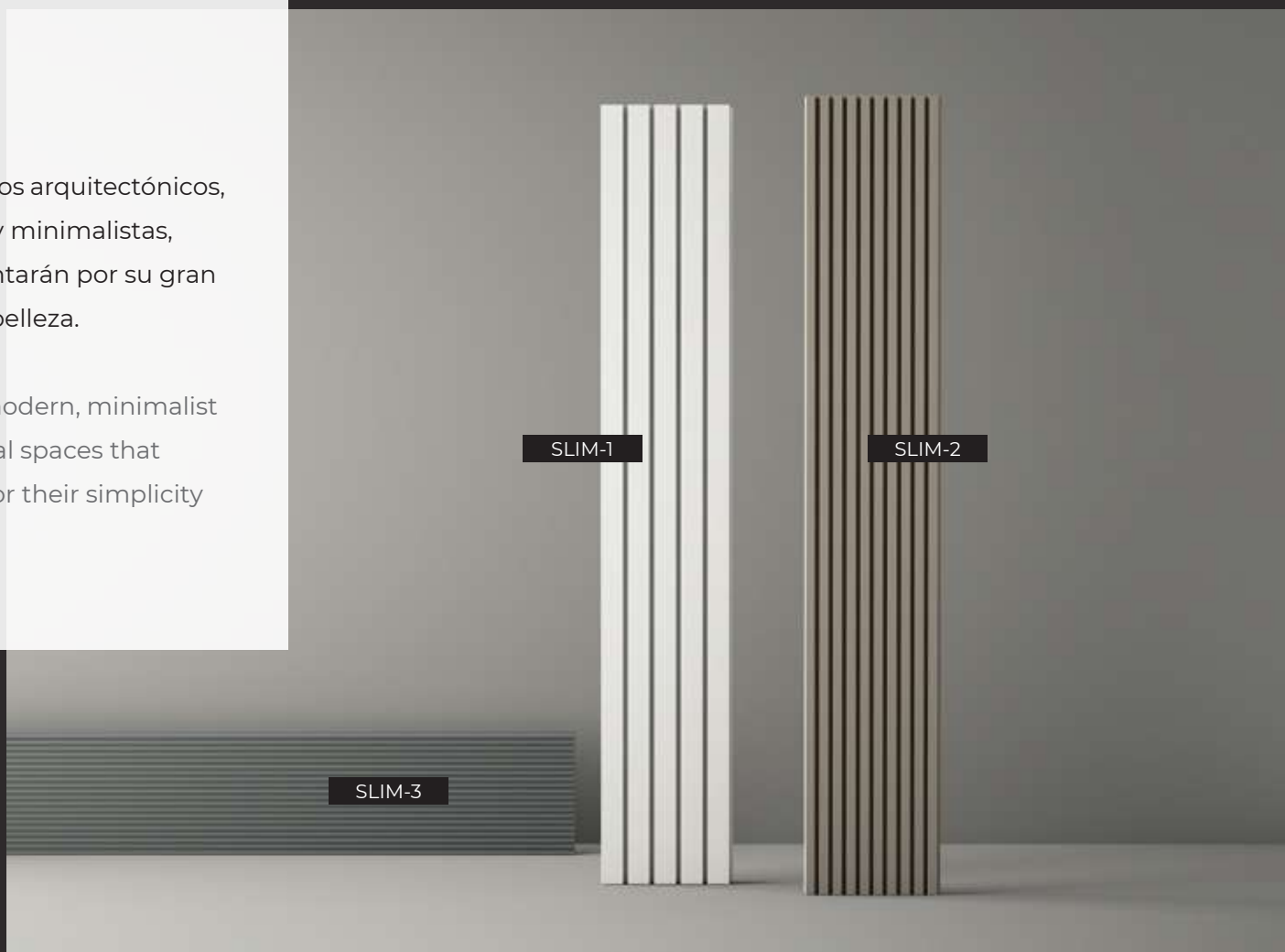



museum

SLIM-2 LX-721 NEGRO

SLIM-2 LX-721 MARENGO
SLIM-1 LX-720 CREMA
SLIM-3 LX-722 CREMA
PERFIL L LX-PLL CREMA

Versatilidad
Versatility

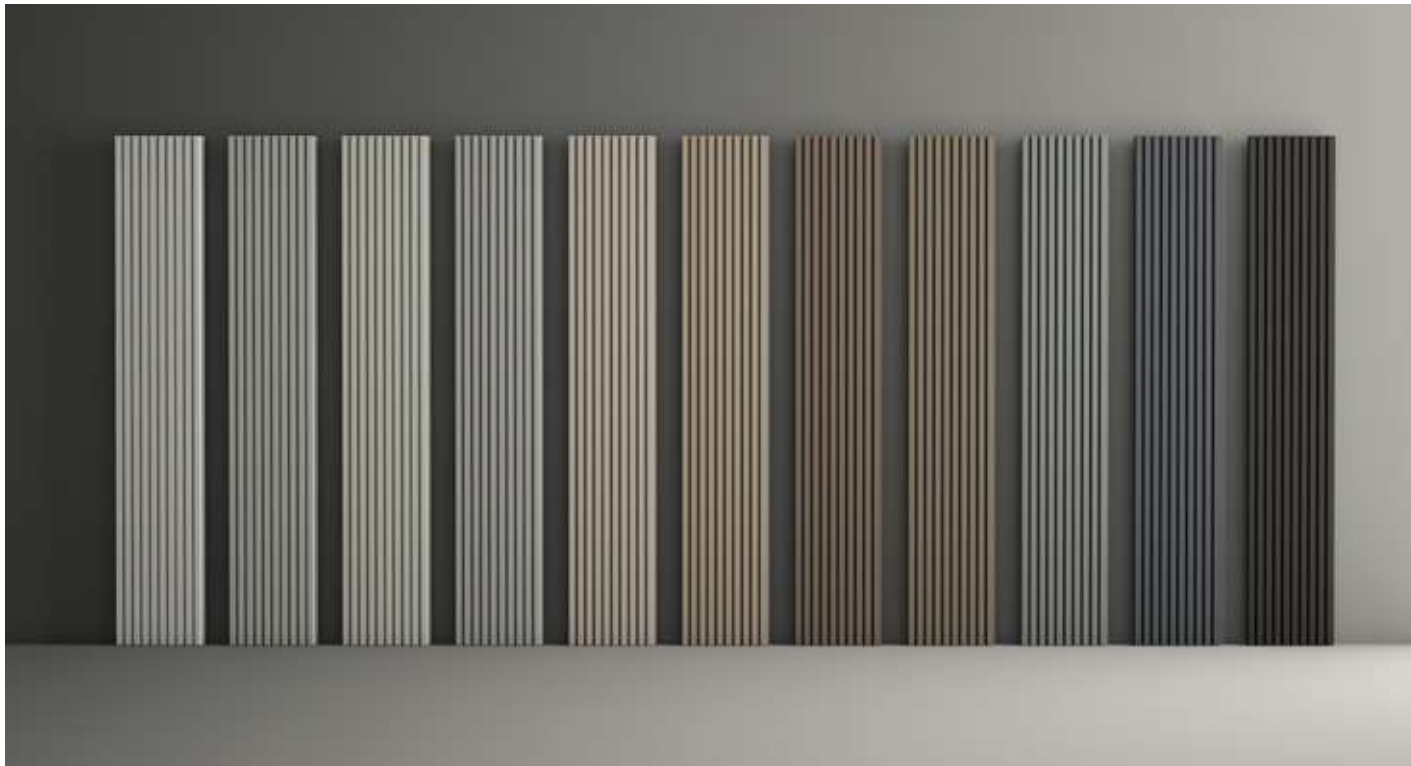



SLIM-2 LX-721 CAMEL
SLIM-3 LX-722 CAMEL



SLIM-2 LX-721 BLANCO





SLIM-2 LX-721 BLANCO

SLIM-1 LX-720 CREMA
PERFIL L LX-PLL CREMA
SLIM-1 LX-721 CREMA



Arquitek SLIM

Medidas en cm. / Measures in cm.

Las medidas pueden variar +/-1cm / Measurements may vary +/-1cm

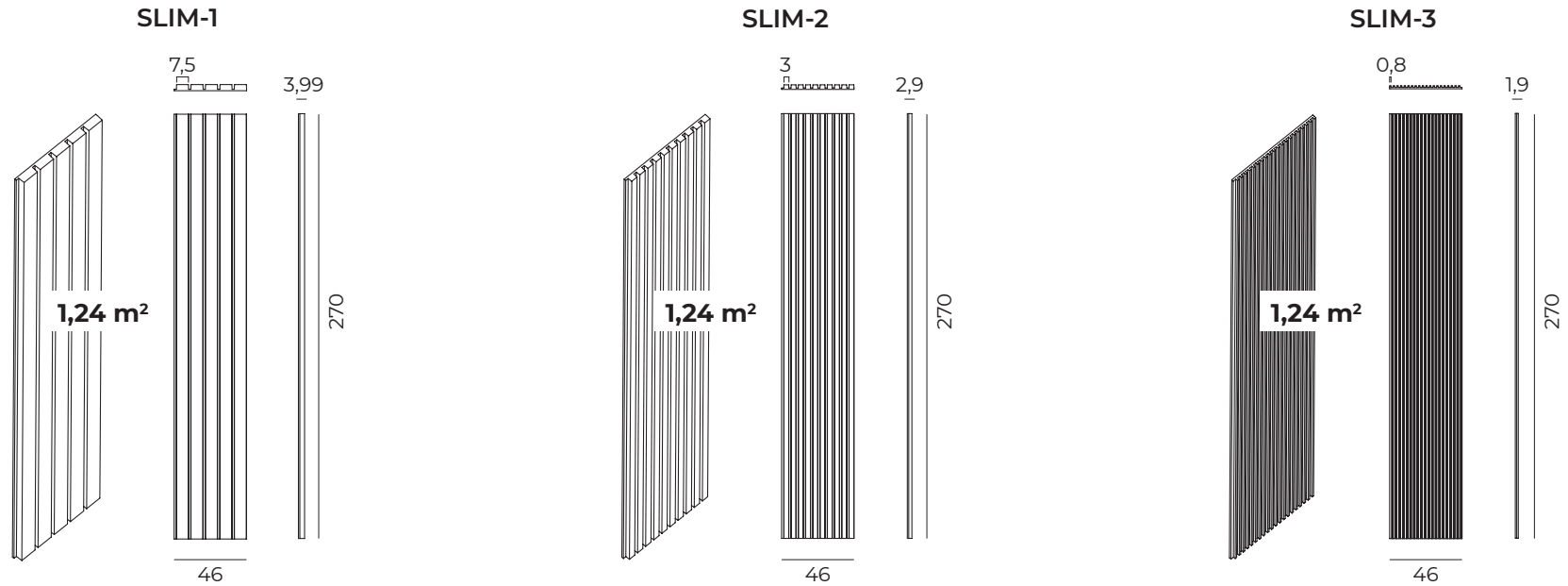

*SE PUEDEN COMBINAR CON NUESTROS PERFILES / *CAN BE COMBINED WITH OUR PROFILES

Acabado de Colores / Finished Colours

- | | | | |
|-----------------------------|--------------------------------|--------------------------------|---------------------------------|
| 1
BLANCO
WHITE | 15
HUESO
BONE | 2
CREMA
CREAM | 3
CEMENTO
CONCRETE |
| 4
ARENA
SAND | 5
CAMEL
CAMEL | 16
TABACO
TOBACCO | 6
PLOMO
LEAD |
| 7
GRIS
GREY | 8
MARENGO
MARENGO | 9
NEGRO
BLACK | |

*Ver especificaciones de acabados: página 16-17 /
*See finish specifications: page 16-17

CALIDADES / QUALITIES	REFERENCIA / CODE	DESCRIPCIÓN / DESCRIPTION	KG.			PVP € UNIDAD / PRICE € UNIT
	LX-720	Panel SLIM-1	LX: -	LX: -	LX: -	-
	LX-721	Panel SLIM-2	LX: -	LX: -	LX: -	-
	LX-722	Panel SLIM-3	LX: -	LX: -	LX: -	-

Kg., embalaje y palé pueden variar +/- / Kg., packaging and pallet may vary +/-

MILO



MILO

Tres tamaños de grosor para un panel lineal y estructural, con un acabado de cemento muy realista.

Three thickness sizes for a linear, structural panel with a realistic cement finish.

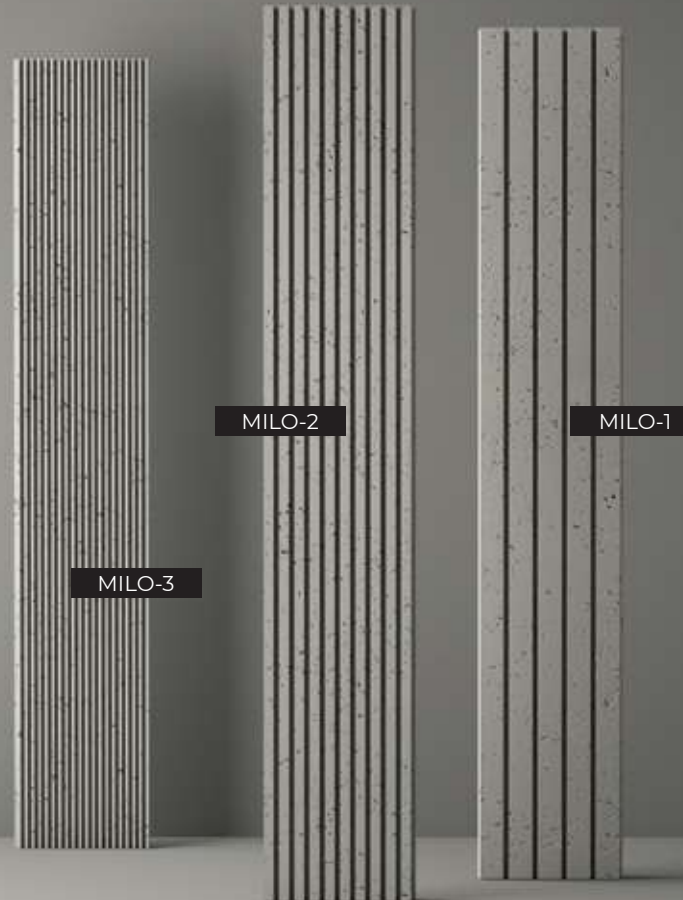



MILO-2 PR-724 IMITACIÓN CEMENTO

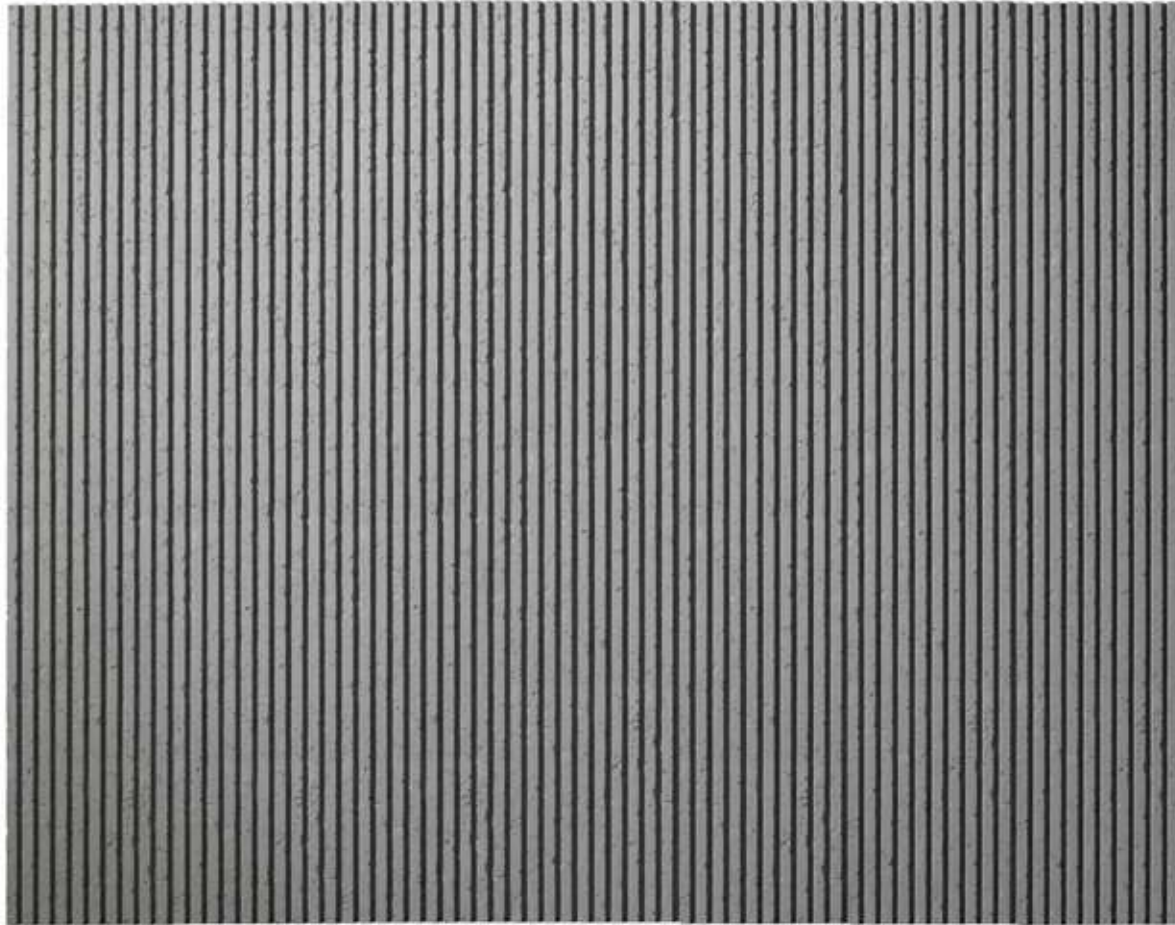



MILO-2 PR-724 IMITACIÓN CEMENTO

Arquitek MILO

Medidas en cm. / Measures in cm.

Las medidas pueden variar +/-1cm. / Measurements may vary +/-1cm

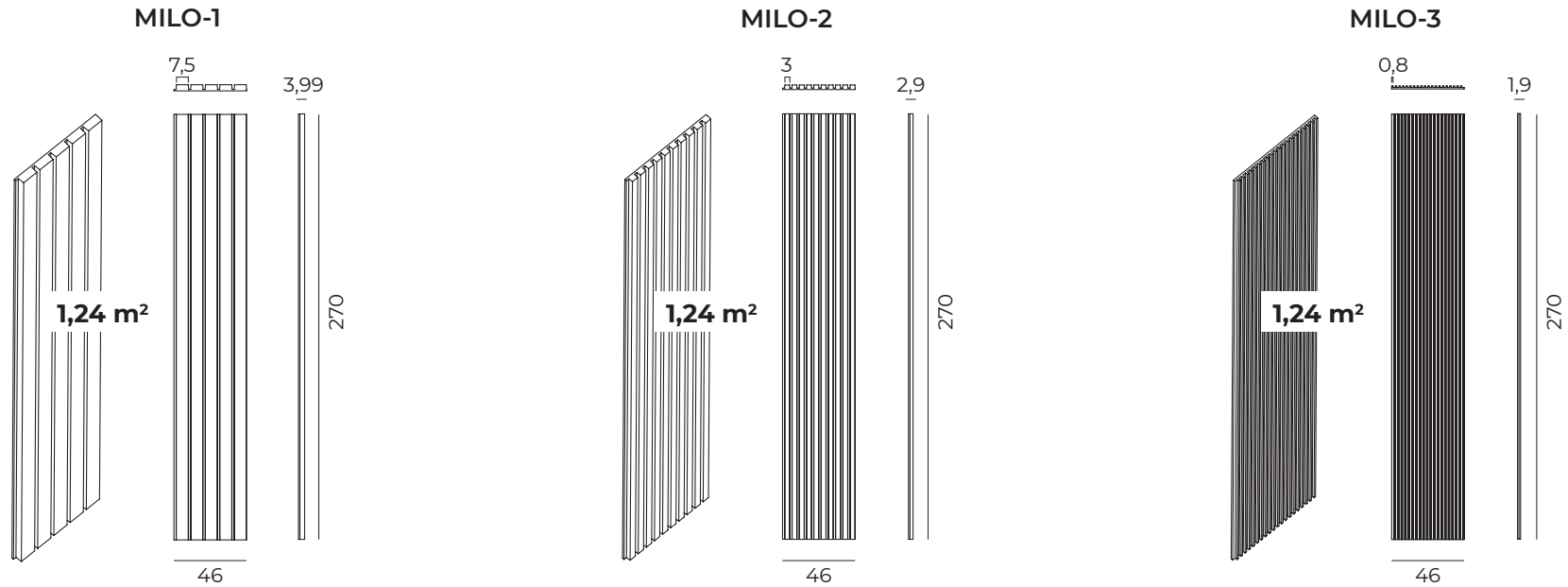

*SE PUEDEN COMBINAR CON NUESTROS PERFILES / *CAN BE COMBINED WITH OUR PROFILES

Acabado de Colores / Finished Colours



IMITACIÓN CEMENTO
IMITATION CONCRETE

*Ver especificaciones de acabados: página 16-17 /
*See finish specifications: page 16-17

CALIDADES / QUALITIES	REFERENCIA / CODE	DESCRIPCIÓN / DESCRIPTION	KG.			PVP € UNIDAD / PRICE € UNIT
	PR-723	Panel MILO-1	PR: -	PR: -	PR: -	-
	PR-724	Panel MILO-2	PR: -	PR: -	PR: -	-
	PR-725	Panel MILO-3	PR: -	PR: -	PR: -	-
	LX-723	Panel MILO-1	LX: -	LX: -	LX: -	-
	LX-724	Panel MILO-2	LX: -	LX: -	LX: -	-
	LX-725	Panel MILO-3	LX: -	LX: -	LX: -	-

Kg., embalaje y palé pueden variar +/- / Kg., packaging and pallet may vary +/-

ICON



ICON

Modelo original y de gran belleza, por su versatilidad a la hora de componer en una pared.

An original model of great beauty, due to its versatility when it comes to composing a wall.

ECO
LUXER

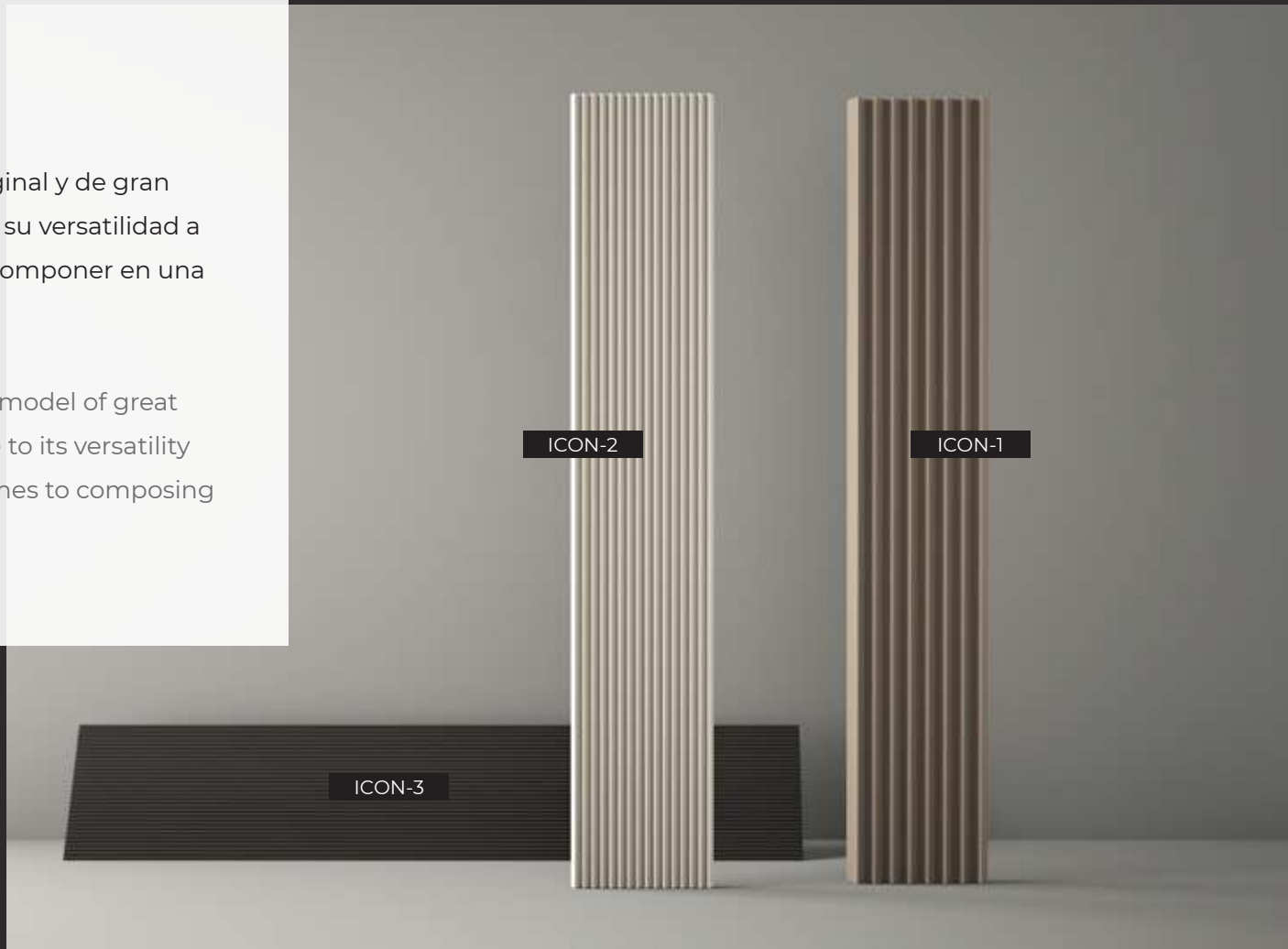



ICON-2 LX-727 BLANCO



ICON-3 LX-728 PLOMO
PERFIL L LX-PLL PLOMO
ICON-1 LX-726 PLOMO
PERFIL M LX-PML PLOMO





ICON-1 LX-726 CREMA
ICON-2 LX-727 CREMA
ICON-3 LX-728 CREMA
PERFIL L LX-PLL CREMA
PERFIL M LX-PML CREMA



ICON-2 LX-727 BLANCO
PERFIL M LX-PML BLANCO



Arquitek ICON

Medidas en cm. / Measures in cm.

Las medidas pueden variar +/-1cm / Measurements may vary +/-1cm

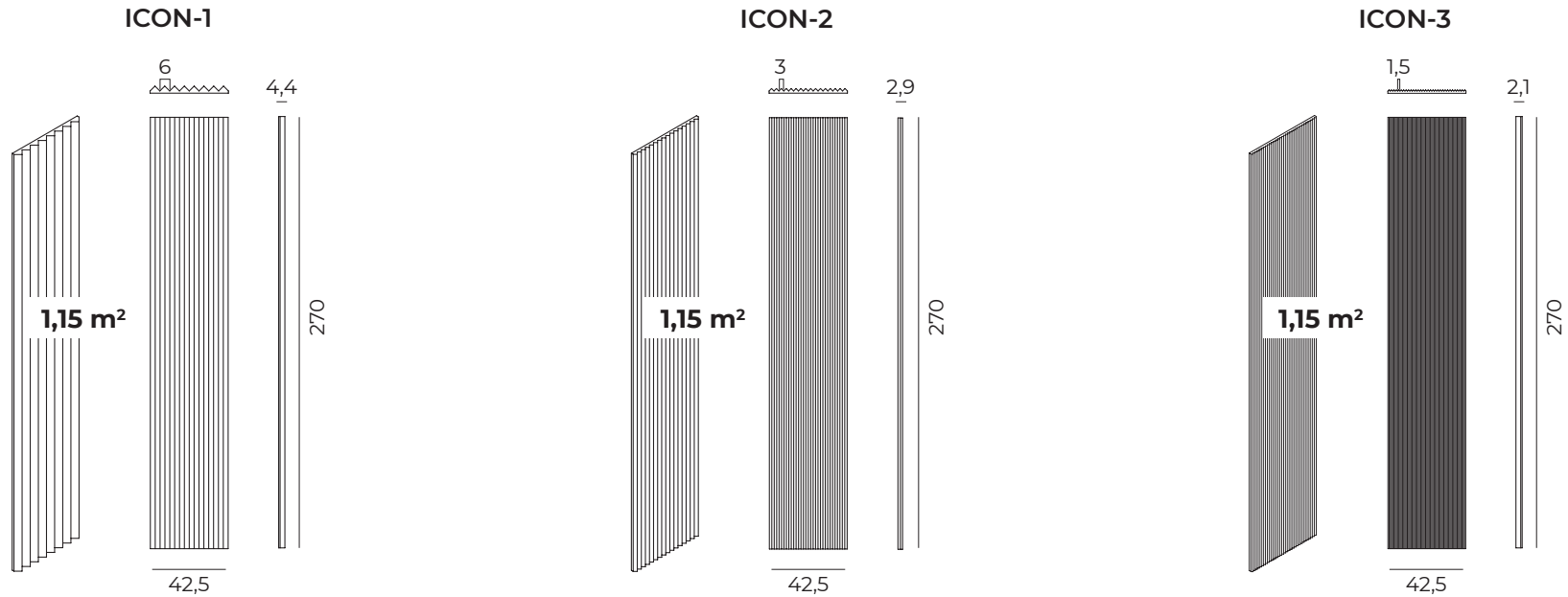

*SE PUEDEN COMBINAR CON NUESTROS PERFILES / *CAN BE COMBINED WITH OUR PROFILES

Acabado de Colores / Finished Colours



*Ver especificaciones de acabados: página 16-17 /
*See finish specifications: page 16-17

CALIDADES / QUALITIES	REFERENCIA / CODE	DESCRIPCIÓN / DESCRIPTION	KG.			PVP € UNIDAD / PRICE € UNIT
	LX-726	Panel ICON-1	LX: -	LX: -	LX: -	-
	LX-727	Panel ICON-2	LX: -	LX: -	LX: -	-
	LX-728	Panel ICON-3	LX: -	LX: -	LX: -	-

SPIRIT



SPIRIT

Modelo similar a Icon pero con imitación cemento. Elegancia en acabado de gran realismo.

Model similar to Icon but with cement imitation, elegance in a very realistic finish.





SPIRIT-1 PR-729 IMITACIÓN CEMENTO
SPIRIT-1 LX-729 IMITACIÓN CEMENTO (Exterior)



SPRIT-3 PR-731 IMITACIÓN CEMENTO
PERFIL L LX-PLL BLANCO
SPRIT-2 PR-730 IMITACIÓN CEMENTO



SPIRIT-1 LX-729 IMITACIÓN CEMENTO (Exterior)
PERFIL L PR-PLC



Arquitek SPIRIT

Medidas en cm. / Measures in cm.

Las medidas pueden variar +/-1cm / Measurements may vary +/-1cm

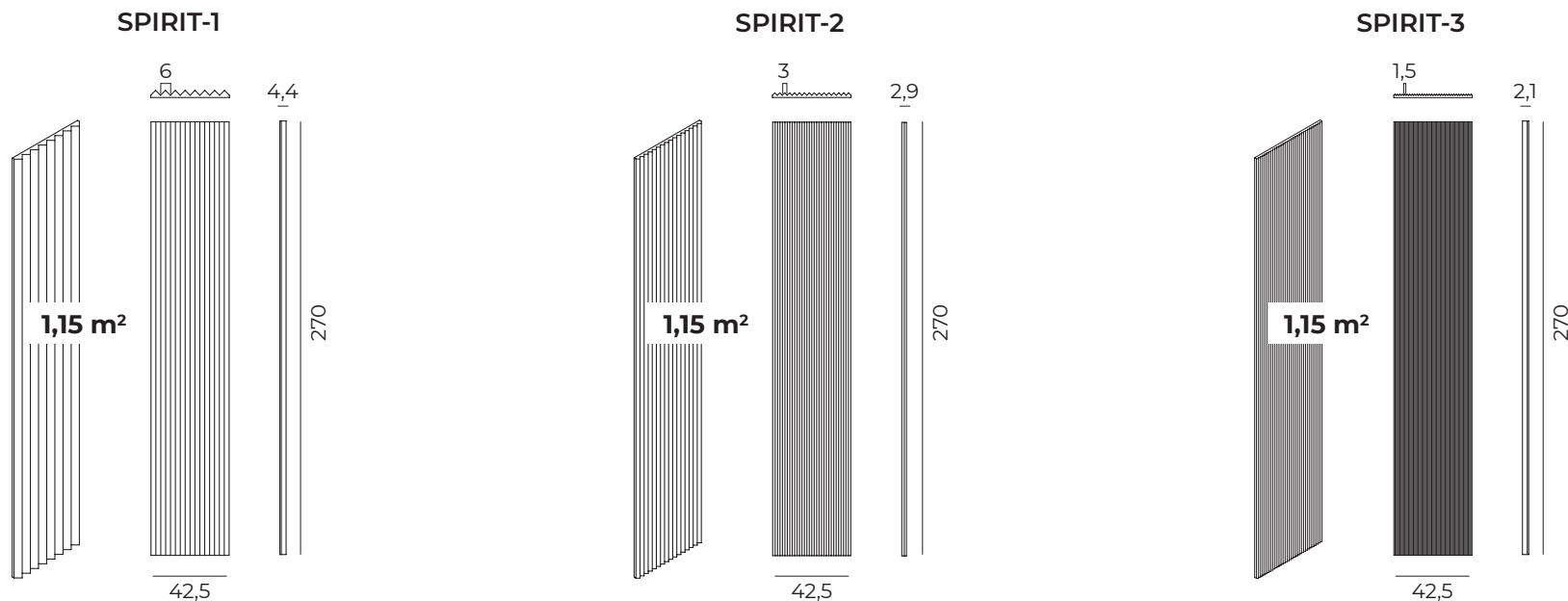





*SE PUEDEN COMBINAR CON NUESTROS PERFILES / *CAN BE COMBINED WITH OUR PROFILES

Acabado de Colores / Finished Colours



IMITACIÓN CEMENTO
IMITATION CONCRETE

*Ver especificaciones de acabados: página 16-17 /
*See finish specifications: page 16-17

CALIDADES / QUALITIES	REFERENCIA / CODE	DESCRIPCIÓN / DESCRIPTION	KG.			PVP € UNIDAD / PRICE € UNIT
	PR-729	Panel SPIRIT-1	PR: -	PR: -	PR: -	-
	PR-730	Panel SPIRIT-2	PR: -	PR: -	PR: -	-
	PR-731	Panel SPIRIT-3	PR: -	PR: -	PR: -	-
	LX-729	Panel SPIRIT-1	LX: -	LX: -	LX: -	-
	LX-730	Panel SPIRIT-2	LX: -	LX: -	LX: -	-
	LX-731	Panel SPIRIT-3	LX: -	LX: -	LX: -	-

Kg., embalaje y palé pueden variar +/- / Kg., packaging and pallet may vary +/-

ARKO



ARKO

Modelo pensado para crear espacios arquitectónicos espectaculares, por su fácil combinación y composición entre sus cuatro tamaños.

Model designed to create spectacular architectural spaces, due to its easy combination and composition between its four sizes.

ECO
LUXER





ARKO-1 LX-732 ARENA
PERFIL L LX-PLL ARENA
ARKO-3 LX-734 CAMEL

ARKO-1 LX-732 ARENA
PERFIL L LX-PLL ARENA
ARKO-3 LX-734 CAMEL



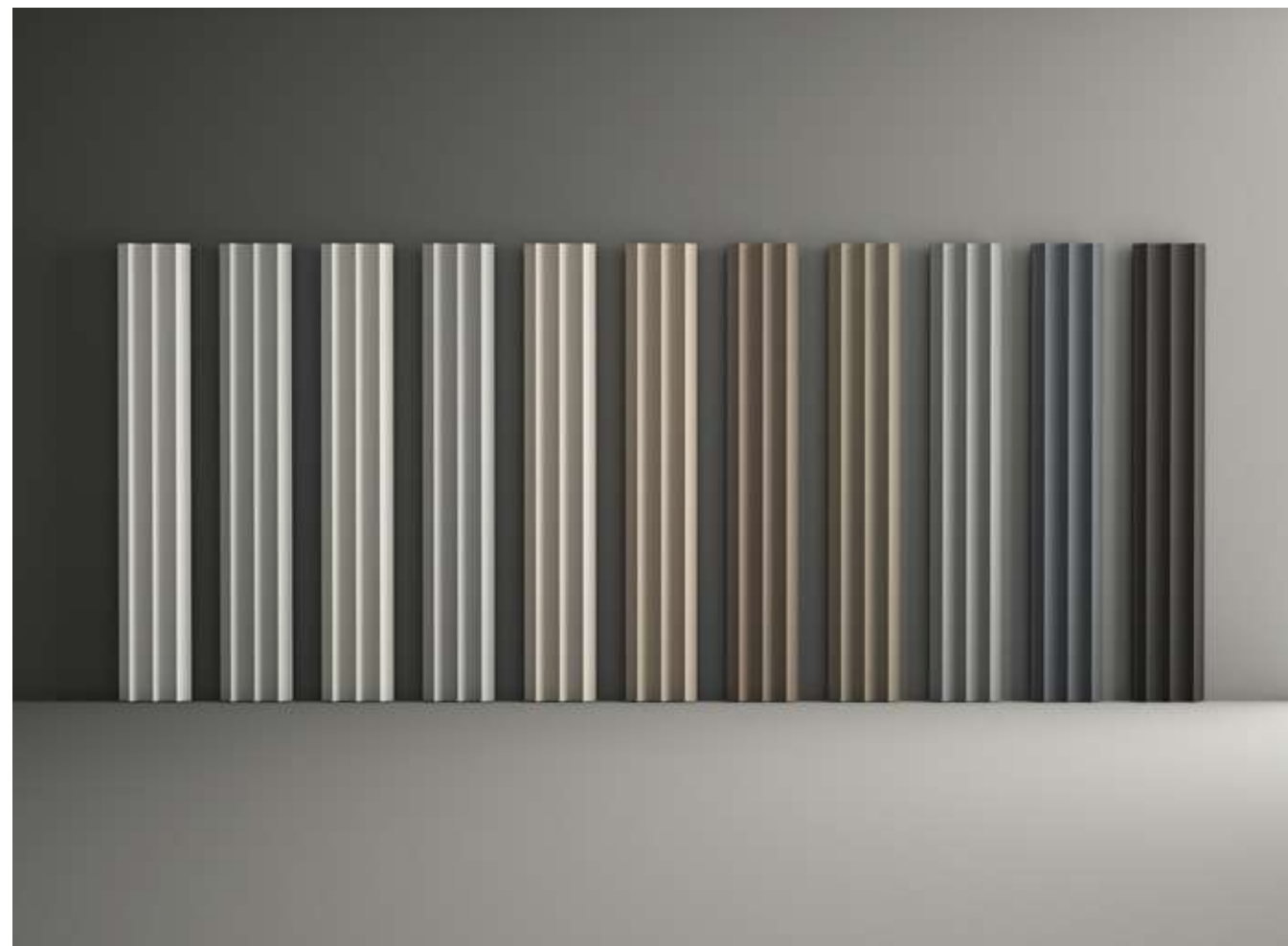



ARKO-2 LX-733 HUESO
ARKO-1 LX-732 MARENGO

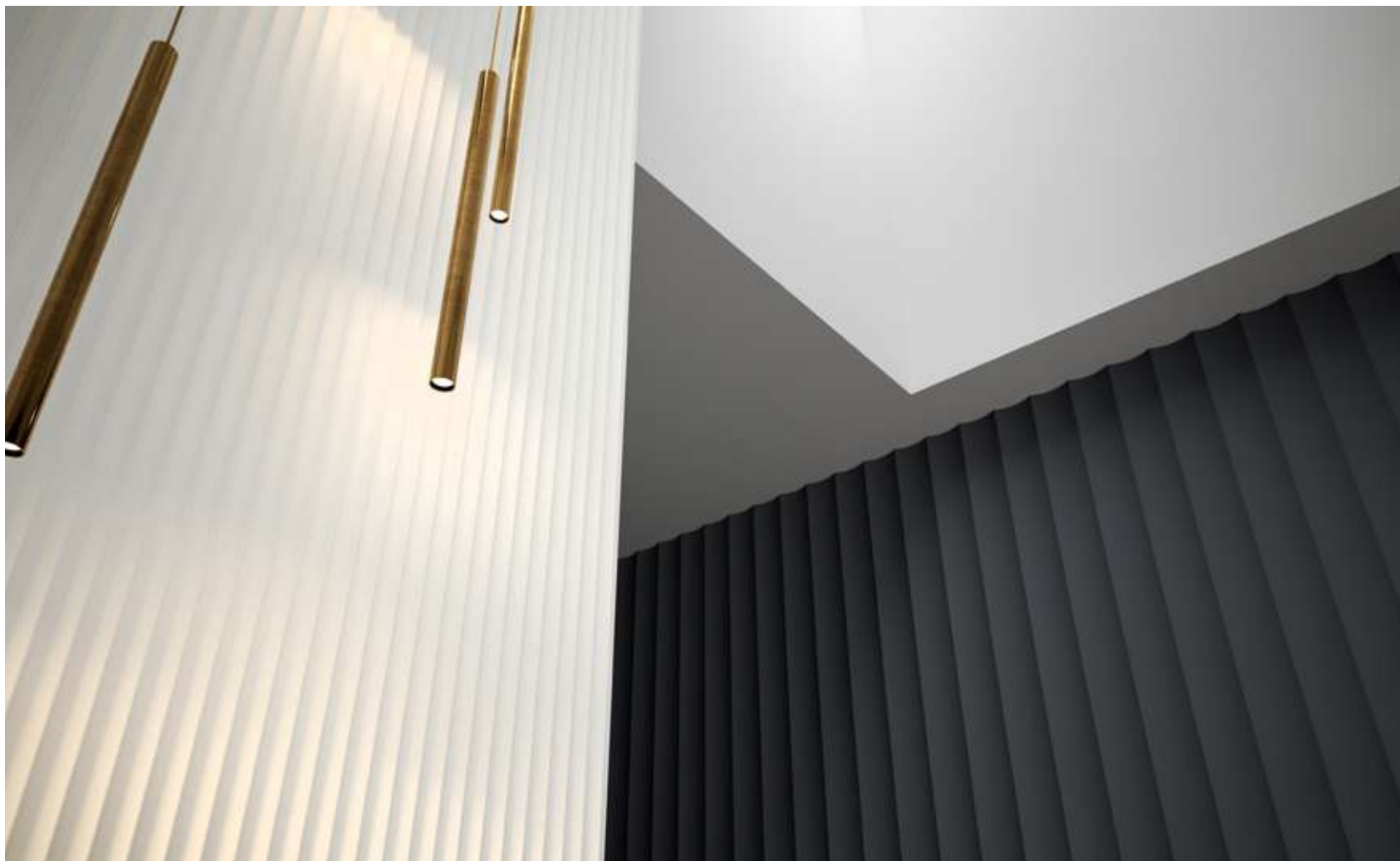

A photograph of a window treatment. On the left, there are dark brown vertical blinds. To the right, there is a light-colored roller blind with three horizontal bands. Below the roller blind, there are two sets of vertical blinds: one in a light beige color and one in a medium brown color. The text 'Infinitas combinaciones' and 'Infinite combinations' is overlaid on the left side of the image.

Infinitas
combinaciones
Infinite combinations

Arquitek ARKO

Medidas en cm. / Measures in cm.

Las medidas pueden variar +/-1cm / Measurements may vary +/-1cm

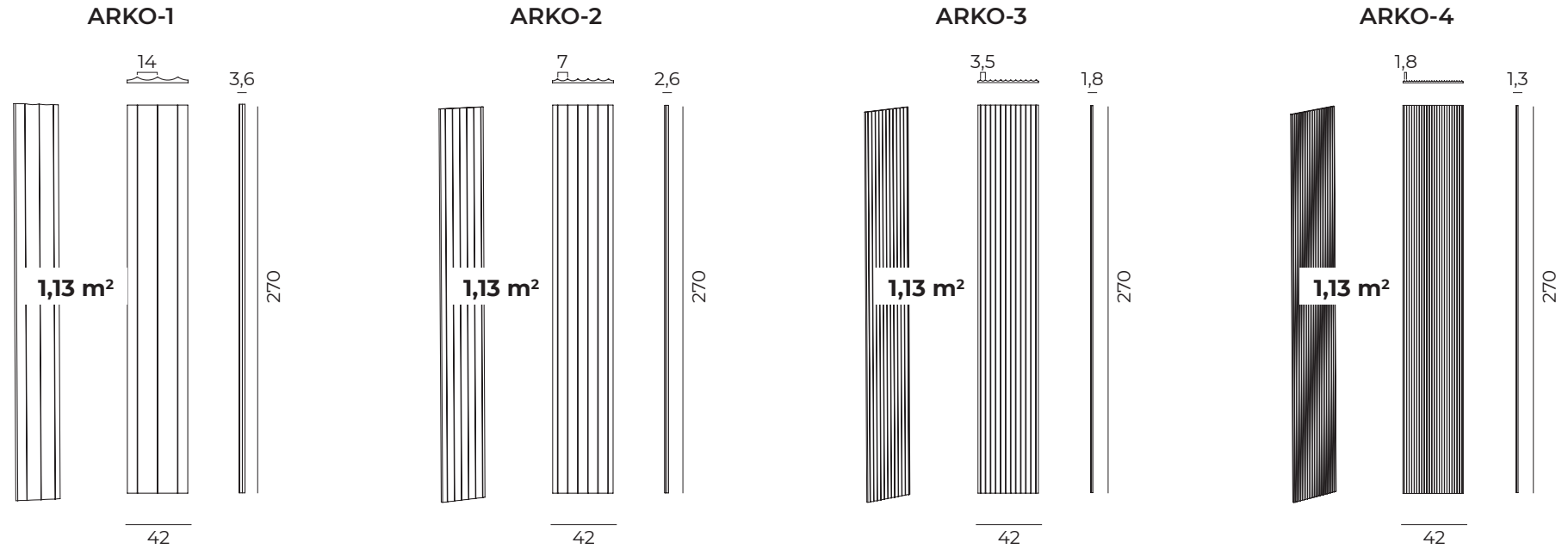

*SE PUEDEN COMBINAR CON NUESTROS PERFILES / *CAN BE COMBINED WITH OUR PROFILES

Acabado de Colores / Finished Colours



*Ver especificaciones de acabados: página 16-17 /
*See finish specifications: page 16-17

CALIDADES / QUALITIES	REFERENCIA / CODE	DESCRIPCIÓN / DESCRIPTION	KG.			PVP € UNIDAD / PRICE € UNIT
	LX-732	Panel ARKO-1	LX: -	LX: -	LX: -	-
	LX-733	Panel ARKO-2	LX: -	LX: -	LX: -	-
	LX-734	Panel ARKO-3	LX: -	LX: -	LX: -	-
	LX-735	Panel ARKO-4	LX: -	LX: -	LX: -	-

Kg., embalaje y palé pueden variar +/- / Kg., packaging and pallet may vary +/-

ALMA



ALMA

Igual de espectacular que el modelo Arko pero con acabado cemento de gran realismo.

Just as spectacular as the Arko model but with a very realistic ceme



ALMA-4

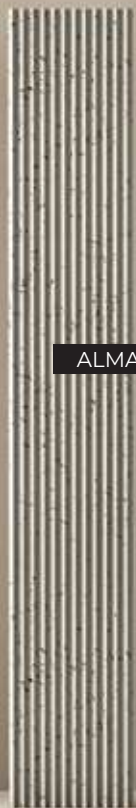

ALMA-3



ALMA-1



ALMA-2

PR

ECO
LUXER



ALMA-1 PR-736 IMITACIÓN CEMENTO
HORMIGÓN PR-326 GRIS (Cement Collection)

ALMA-3 PR-738 IMITACIÓN CEMENTO
ALMA-1 PR-736 IMITACIÓN CEMENTO
PERFIL M LX-PML GRIS







Combinable with other collections
Combinables
con otras colecciones

ALMA-1 PR-736 IMITACIÓN CEMENTO
HORMIGÓN PR-326 GRIS (Cement Collection)

Arquitek ALMA

Medidas en cm. / Measures in cm.

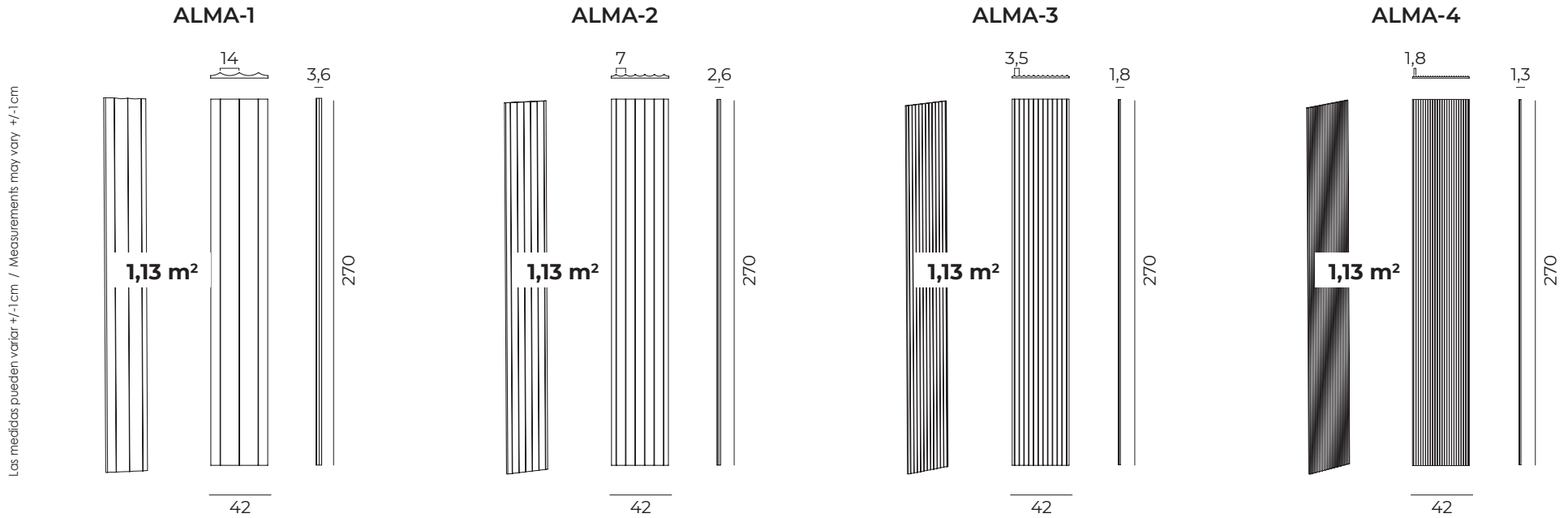





*SE PUEDEN COMBINAR CON NUESTROS PERFILES / *CAN BE COMBINED WITH OUR PROFILES

Acabado de Colores / Finished Colours



IMITACIÓN CEMENTO
IMITATION CONCRETE

*Ver especificaciones de acabados: página 16-17 /
*See finish specifications: page 16-17

CALIDADES / QUALITIES	REFERENCIA / CODE	DESCRIPCIÓN / DESCRIPTION	KG.			PVP € UNIDAD / PRICE € UNIT
	PR-736	Panel ALMA-1	PR: -	PR: -	PR: -	-
	PR-737	Panel ALMA-2	PR: -	PR: -	PR: -	-
	PR-738	Panel ALMA-3	PR: -	PR: -	PR: -	-
	PR-739	Panel ALMA-4	PR: -	PR: -	PR: -	-
	LX-736	Panel ALMA-1	LX: -	LX: -	LX: -	-
	LX-737	Panel ALMA-2	LX: -	LX: -	LX: -	-
	LX-738	Panel ALMA-3	LX: -	LX: -	LX: -	-
	LX-739	Panel ALMA-4	LX: -	LX: -	LX: -	-

Kg., embalaje y palé pueden variar +/- / Kg., packaging and pallet may vary +/-

MODUS



MODUS

Unos de nuestros paneles mas elegantes es, sin duda, el modelo Modus. En cualquier color, es simplemente bello.

One of our most elegant panels is undoubtedly the Modus model. In any colour, it is simply beautiful.

ECO
LUXER





MODUS LX-747 CAMEL

MODUS LX-747 CAMEL



MODUS LX-747 NEGRO





MODUS LX-747 BLANCO



Belleza

Beauty



Arquitek MODUS

Medidas en cm. / Measures in cm.

Las medidas pueden variar +/-1cm / Measurements may vary +/-1cm

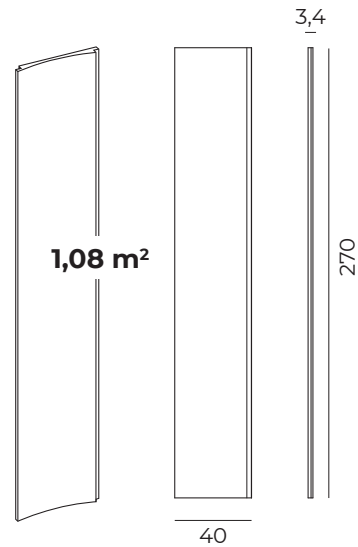

*SE PUEDEN COMBINAR CON NUESTROS PERFILES / *CAN BE COMBINED WITH OUR PROFILES

Acabado de Colores / Finished Colours



*Ver especificaciones de acabados: página 16-17 /
*See finish specifications: page 16-17

CALIDADES / QUALITIES	REFERENCIA / CODE	DESCRIPCIÓN / DESCRIPTION	KG.			PVP € UNIDAD / PRICE € UNIT
	LX-747	Panel MODUS	LX: -	LX: -	LX: -	-

Kg., embalaje y palé pueden variar +/- / Kg., packaging and pallet may vary +/-

NEOS



NEOS

Unos de los modelos más elegante junto con Modus. Con un acabado cemento, simplemente espectacular.

One of the most elegant models together with Modus. With a cement finish, simply spectacular.



NEOS

PR

ECO
LUXER



NEOS PR-740 IMITACIÓN CEMENTO





NEOS PR-740 IMITACIÓN CEMENTO



Arquitek NEOS

Medidas en cm. / Measures in cm.

Las medidas pueden variar +/-1cm / Measurements may vary +/-1cm

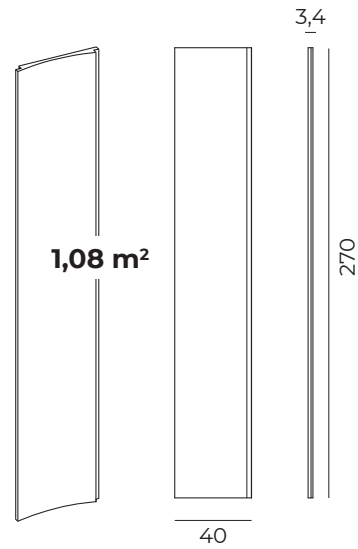





*SE PUEDEN COMBINAR CON NUESTROS PERFILES / *CAN BE COMBINED WITH OUR PROFILES

Acabado de Colores / Finished Colours



IMITACIÓN CEMENTO
IMITATION CONCRETE

*Ver especificaciones de acabados: página 16-17 /
*See finish specifications: page 16-17

CALIDADES / QUALITIES	REFERENCIA / CODE	DESCRIPCIÓN / DESCRIPTION	KG.			PVP € UNIDAD / PRICE € UNIT
	PR-740	Panel NEOS	PR: -	PR: -	PR: -	-
	LX-740	Panel NEOS	LX: -	LX: -	LX: -	-

Kg., embalaje y palé pueden variar +/- / Kg., packaging and pallet may vary +/-

SCALON



SCALON

Por sus formas originales y lineales hacen que este panel sea uno de los más bellos y modernos.

Its original and linear shapes make this panel one of the most beautiful and modern.

ECO
LUXER





SCALON-1 LX-741 GRIS
SCALON-1 LX-741 HUESO

SCALON-1 LX-741 GRIS
PERFIL L LX-PLL GRIS
SCALON-1 LX-741 HUESO
SCALON-1 LX-741 MARENGO
PERFIL L LX-PLL MARENGO



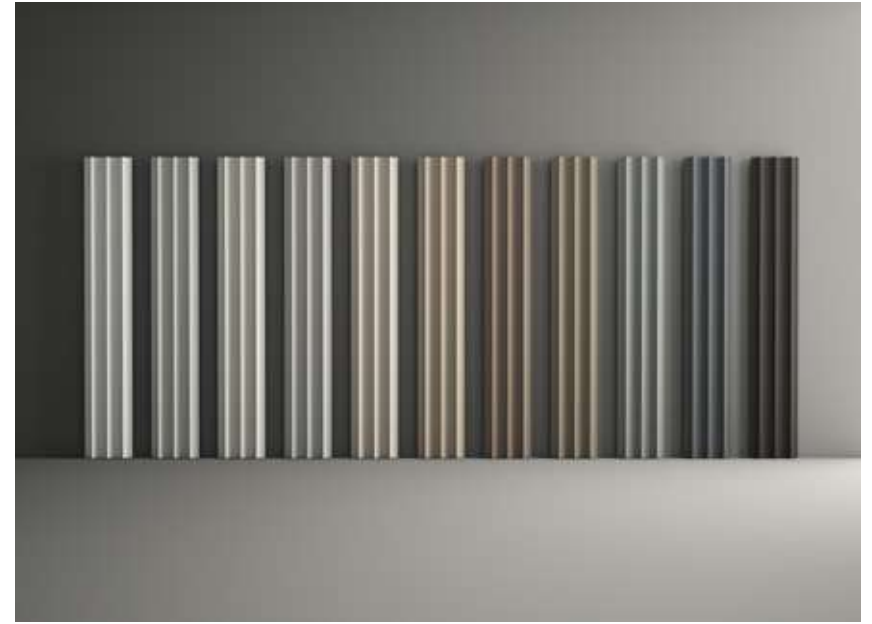

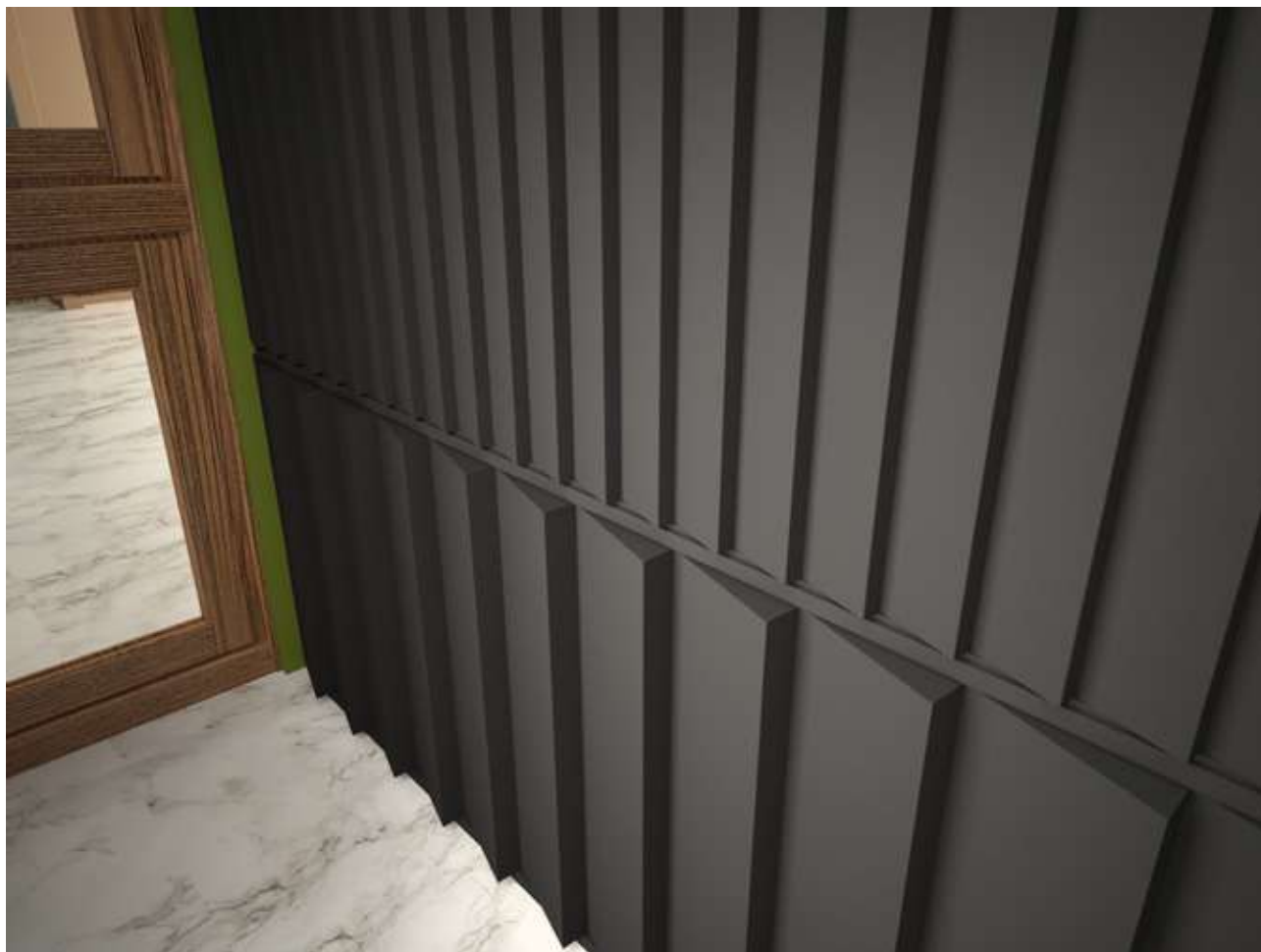

SCALON 2 LX-742 MARENGO

PERFIL L LX-PLL MARENGO

SCALON 1 LX-741 MARENGO



hab: 501-508

Variedad de
posibilidades
Variety of possibilities



Arquitek SCALON

Medidas en cm. / Measures in cm.

Las medidas pueden variar +/-1cm / Measurements may vary +/-1cm

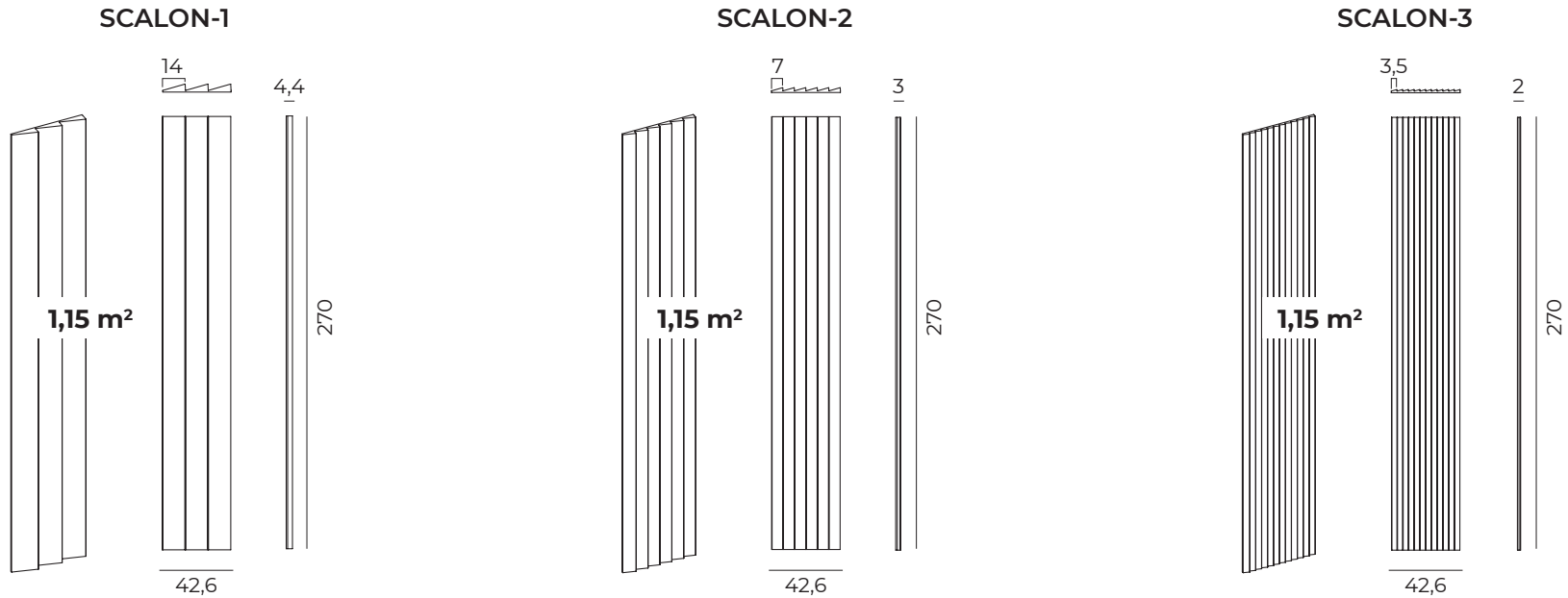



*SE PUEDEN COMBINAR CON NUESTROS PERFILES / *CAN BE COMBINED WITH OUR PROFILES

Acabado de Colores / Finished Colours



*Ver especificaciones de acabados: página 16-17 /
*See finish specifications: page 16-17

CALIDADES / QUALITIES	REFERENCIA / CODE	DESCRIPCIÓN / DESCRIPTION	KG.			PVP € UNIDAD / PRICE € UNIT
	LX-741	Panel SCALON-1	LX: -	LX: -	LX: -	-
	LX-742	Panel SCALON-2	LX: -	LX: -	LX: -	-
	LX-743	Panel SCALON-3	LX: -	LX: -	LX: -	-

Kg., embalaje y palé pueden variar +/- / Kg., packaging and pallet may vary +/-

LOUN



LOUN

Paneles en tres grosores de original diseño con una acabado de cemento perfectamente conseguido.

Panels in three thicknesses of original design with a perfectly achieved cement finish.





LOUN-2 PR-745 IMITACIÓN CEMENTO







LOUN-1 PR-744 IMITACIÓN CEMENTO
LOUN-3 PR-746 IMITACIÓN CEMENTO
LOUN-2 PR-745 IMITACIÓN CEMENTO





Arquitek LOUN

Medidas en cm. / Measures in cm.

Las medidas pueden variar +/-1cm / Measurements may vary +/-1cm

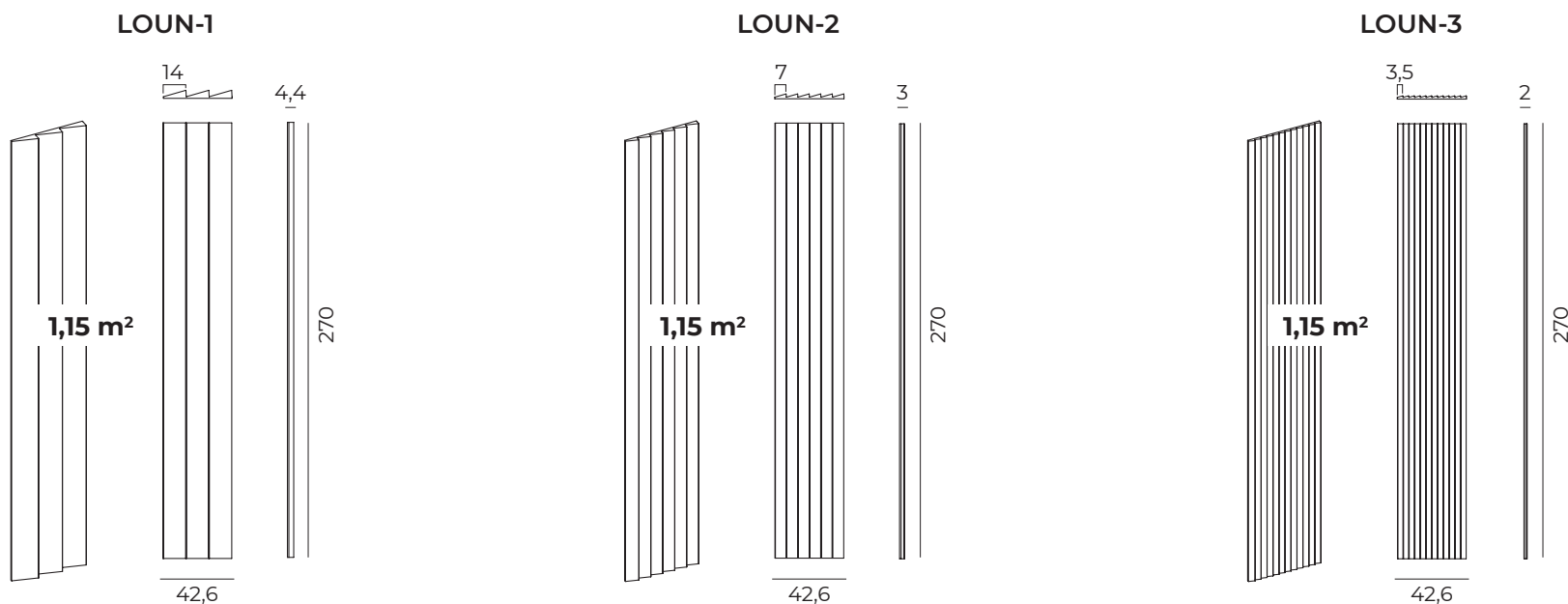





*SE PUEDEN COMBINAR CON NUESTROS PERFILES / *CAN BE COMBINED WITH OUR PROFILES

Acabado de Colores / Finished Colours



IMITACIÓN CEMENTO
IMITATION CONCRETE

*Ver especificaciones de acabados: página 16-17 /
*See finish specifications: page 16-17

CALIDADES / QUALITIES	REFERENCIA / CODE	DESCRIPCIÓN / DESCRIPTION	KG.			PVP € UNIDAD / PRICE € UNIT
	PR-744	Panel LOUN-1	PR: -	PR: -	PR: -	-
	PR-745	Panel LOUN-2	PR: -	PR: -	PR: -	-
	PR-746	Panel LOUN-3	PR: -	PR: -	PR: -	-
	LX-744	Panel SPIRIT-1	LX: -	LX: -	LX: -	-
	LX-745	Panel SPIRIT-2	LX: -	LX: -	LX: -	-
	LX-746	Panel SPIRIT-3	LX: -	LX: -	LX: -	-

Kg., embalaje y palé pueden variar +/- / Kg., packaging and pallet may vary +/-

INNER



INNER

Panel en un solo tamaño, con un diseño original y creativo hará de cualquier estancia un espacio diferente.

Panel in one size, with an original and creative design will make any room a different space.

ECO
LUXER

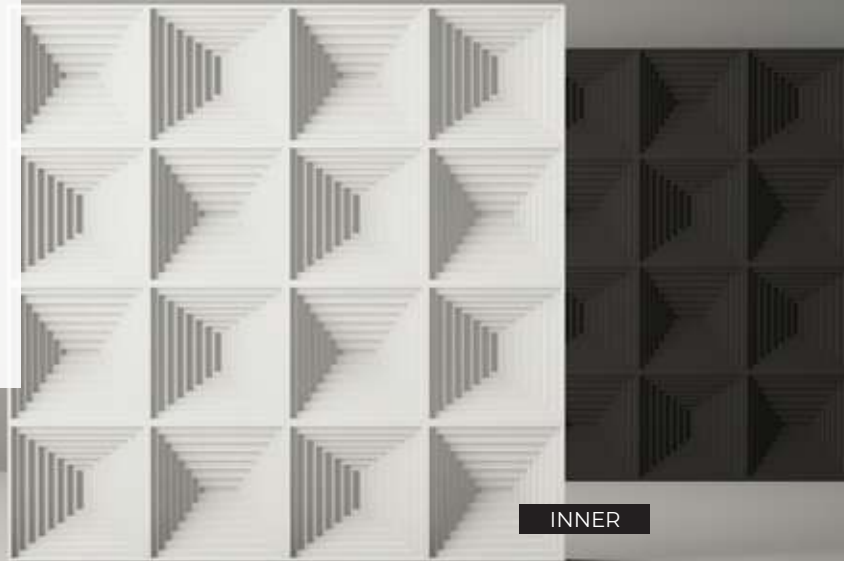

INNER

INNER LX-748 BLANCO



INNER LX-748 BLANCO

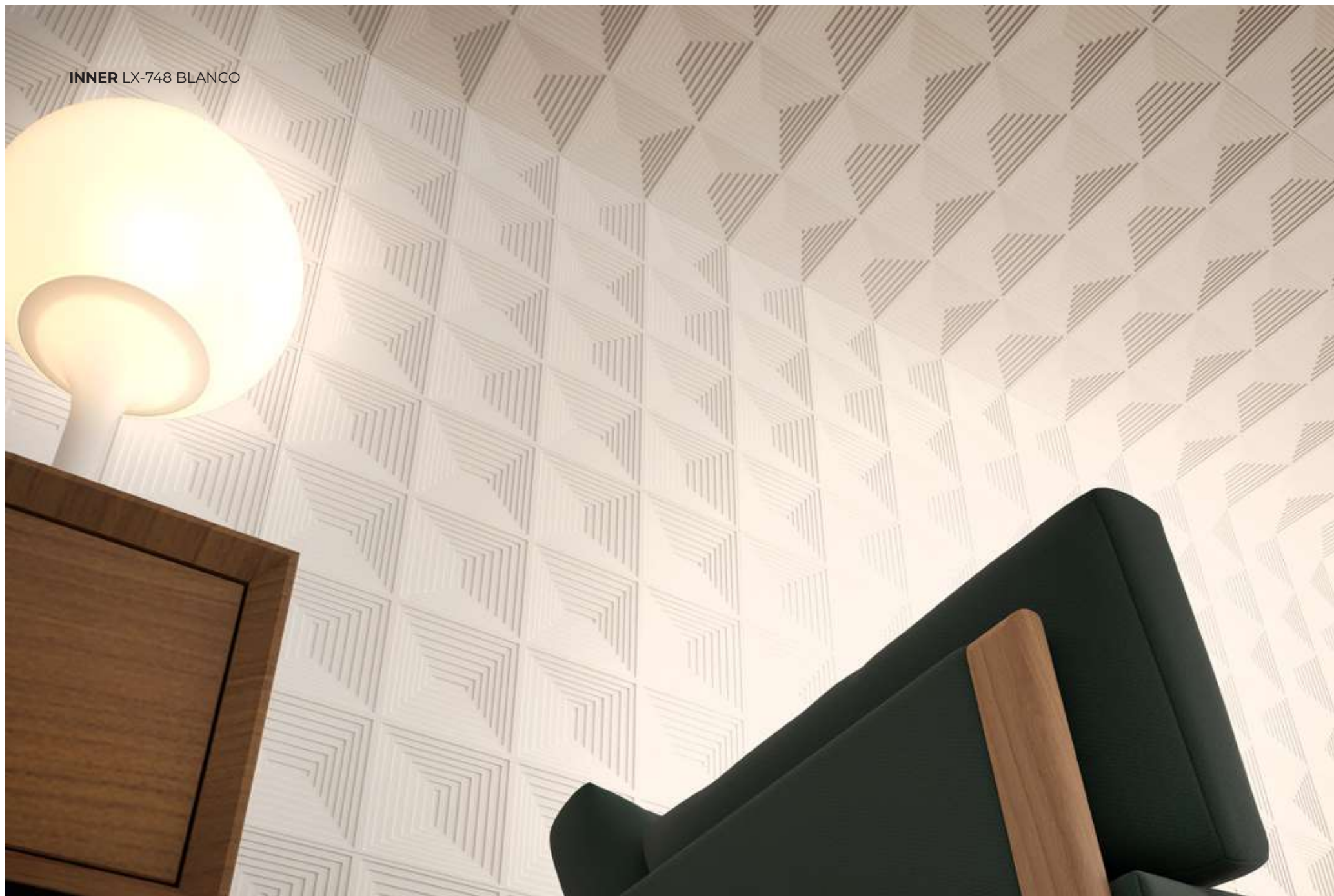

INNER LX-748 BLANCO



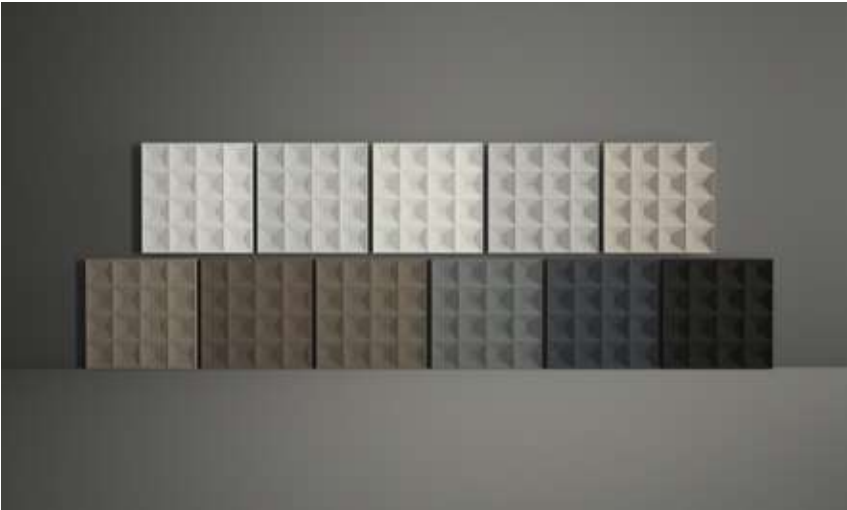

Arquitek INNER

Medidas en cm. / Measures in cm.

Las medidas pueden variar +/-1cm / Measurements may vary +/-1cm

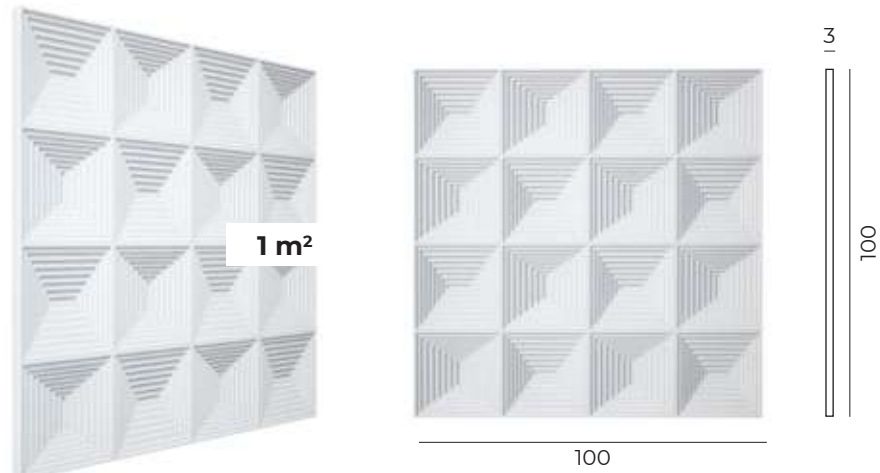

*SE PUEDEN COMBINAR CON NUESTROS PERFILES / *CAN BE COMBINED WITH OUR PROFILES

Acabado de Colores / Finished Colours

- | | | | |
|-----------------------------|--------------------------------|--------------------------------|---------------------------------|
| 1
BLANCO
WHITE | 15
HUESO
BONE | 2
CREMA
CREAM | 3
CEMENTO
CONCRETE |
| 4
ARENA
SAND | 5
CAMEL
CAMEL | 16
TABACO
TOBACCO | 6
PLOMO
LEAD |
| 7
GRIS
GREY | 8
MARENGO
MARENGO | 9
NEGRO
BLACK | |

*Ver especificaciones de acabados: página 16-17 /
 *See finish specifications: page 16-17

CALIDADES / QUALITIES	REFERENCIA / CODE	DESCRIPCIÓN / DESCRIPTION	KG.			PVP € UNIDAD / PRICE € UNIT
	LX-748	Panel INNER	LX: -	LX: -	LX: -	-

Kg., embalaje y palé pueden variar +/- / Kg., packaging and pallet may vary +/-

RINN



RINN

Panel en un solo tamaño, con un diseño original y creativo y con un acabado imitación cemento totalmente realista.

Panel in a single size, with an original and creative design and a totally realistic cement imitation finish.

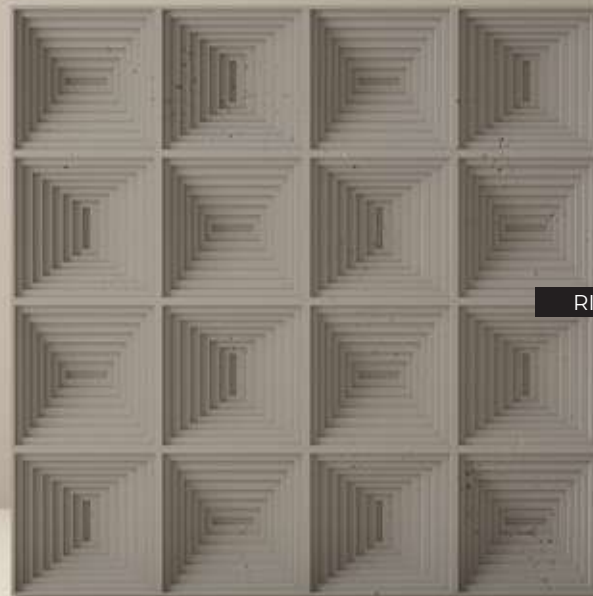

RINN

PR

ECO
LUXER

RINN PR-749 IMITACIÓN CEMENTO



RINN PR-749 IMITACIÓN CEMENTO



Arquitek RINN

Medidas en cm. / Measures in cm.

Las medidas pueden variar +/-1cm / Measurements may vary +/-1cm

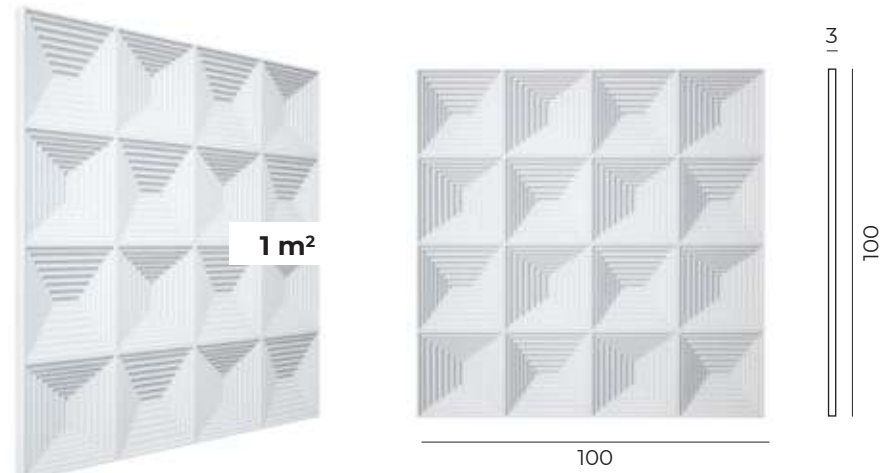





*SE PUEDEN COMBINAR CON NUESTROS PERFILES / *CAN BE COMBINED WITH OUR PROFILES

Acabado de Colores / Finished Colours



IMITACIÓN CEMENTO
IMITATION CONCRETE

*Ver especificaciones de acabados: página 16-17 /
*See finish specifications: page 16-17

CALIDADES / QUALITIES	REFERENCIA / CODE	DESCRIPCIÓN DESCRIPTION	KG.			PVP € UNIDAD PRICE € UNIT
	PR-749	Panel RINN	PR: -	PR: -	PR: -	-
	LX-749	Panel RINN	LX: -	LX: -	LX: -	-

Kg., embalaje y palé pueden variar +/- / Kg., packaging and pallet may vary +/-

BLOM



BLOM

Panel elegante y de gran belleza. Diseñado en un solo tamaño con una amplia gama de colores a combinar.

Elegant and beautiful panel. Designed in one size with a wide range of colours to match.

ECO
LUXER



BLOM LX-750 BLANCO



BLOM LX-750 ARENA

Arquitek BLOM

Medidas en cm. / Measures in cm.

Las medidas pueden variar +/-1cm / Measurements may vary +/-1cm

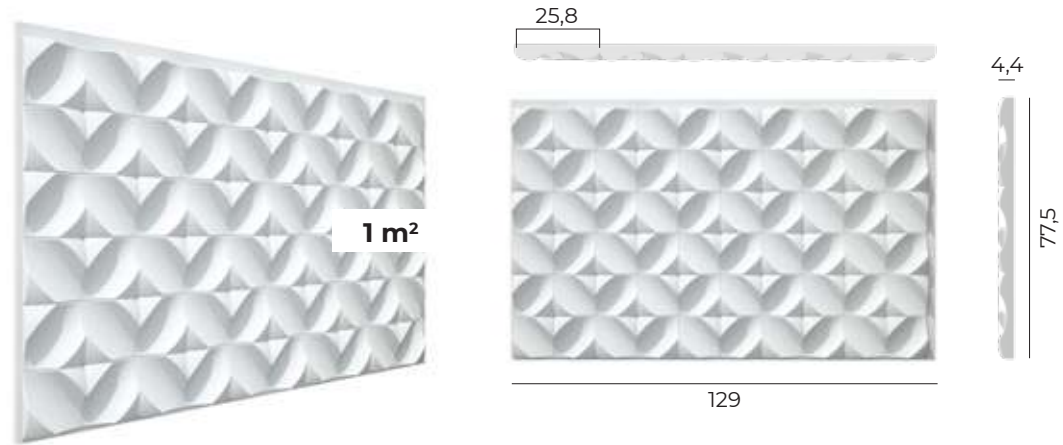

*SE PUEDEN COMBINAR CON NUESTROS PERFILES / *CAN BE COMBINED WITH OUR PROFILES

Acabado de Colores / Finished Colours

- | | | | |
|-----------------------------|--------------------------------|--------------------------------|---------------------------------|
| 1
BLANCO
WHITE | 15
HUESO
BONE | 2
CREMA
CREAM | 3
CEMENTO
CONCRETE |
| 4
ARENA
SAND | 5
CAMEL
CAMEL | 16
TABACO
TOBACCO | 6
PLOMO
LEAD |
| 7
GRIS
GREY | 8
MARENGO
MARENGO | 9
NEGRO
BLACK | |

*Ver especificaciones de acabados: página 16-17 /
*See finish specifications: page 16-17

CALIDADES / QUALITIES	REFERENCIA / CODE	DESCRIPCIÓN / DESCRIPTION	KG.			PVP € UNIDAD / PRICE € UNIT
	LX-750	Panel BLOM	LX: -	LX: -	LX: -	-

Kg., embalaje y palé pueden variar +/- / Kg., packaging and pallet may vary +/-

VITA



VITA

Panel elegante y de gran belleza. Diseñado en un solo tamaño con acabado imitación cemento totalmente realista.

Elegant and beautifully crafted panel. Designed in a single size with a totally realistic cement imitation finish.

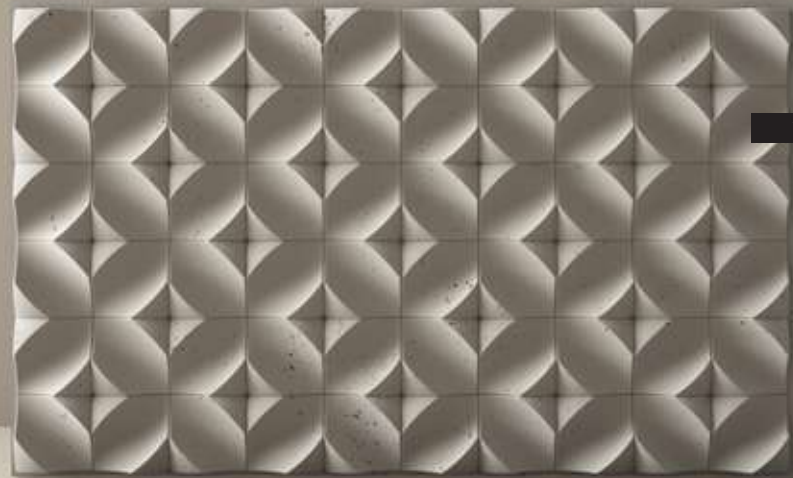

VITA

PR

ECO
LUXER

VITA PR-751 IMITACIÓN CEMENTO



VITA PR-751 IMITACIÓN CEMENTO

Arquitek VITA

Medidas en cm. / Measures in cm.

Las medidas pueden variar +/-1cm / Measurements may vary +/-1cm

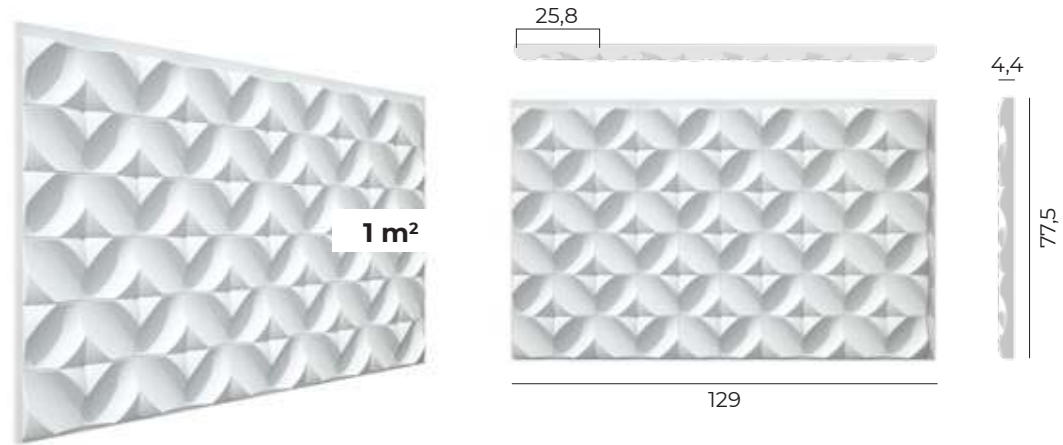





*SE PUEDEN COMBINAR CON NUESTROS PERFILES / *CAN BE COMBINED WITH OUR PROFILES

Acabado de Colores / Finished Colours



IMITACIÓN CEMENTO
IMITATION CONCRETE

*Ver especificaciones de acabados: página 16-17 /
*See finish specifications: page 16-17

CALIDADES / QUALITIES	REFERENCIA / CODE	DESCRIPCIÓN / DESCRIPTION	KG.			PVP € UNIDAD / PRICE € UNIT
	PR-751	Panel VITA	PR: -	PR: -	PR: -	-
	LX-751	Panel VITA	LX: -	LX: -	LX: -	-

Kg., embalaje y palé pueden variar +/- / Kg., packaging and pallet may vary +/-

PERFILES



PERFILES

Diseñados para combinar con los modelos de la Colección Arquitek. Podrás formar zócalos, separaciones intermedias, terminaciones, marcos perimetrales sobre una pared, etc.

Designed to combine with the models in the Arquitek Collection. You can form skirting boards, intermediate partitions, endings, perimeter frames on a wall, etc.





PERFIL L LX-PLL BLANCO

PERFIL M LX-PML MARENGO

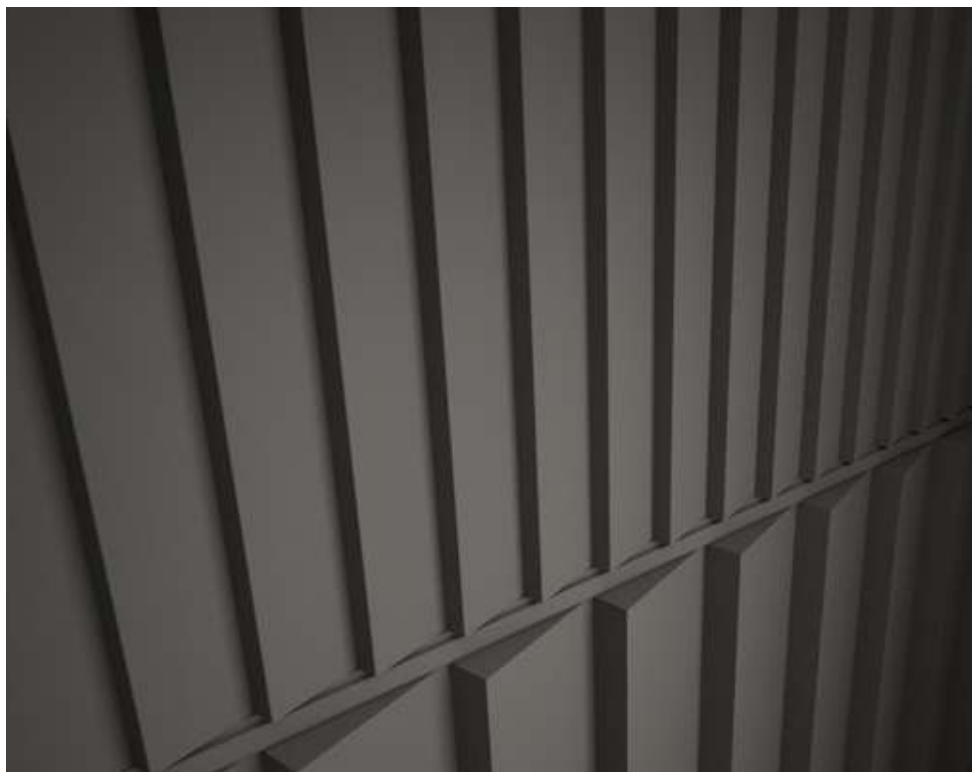

PERFIL L LX-PLL BLANCO (Perimetral)



Arquitek PERFILES

Medidas en cm. / Measures in cm.

Las medidas pueden variar +/-1cm / Measurements may vary +/-1cm

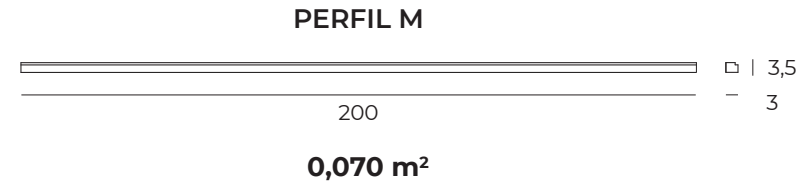
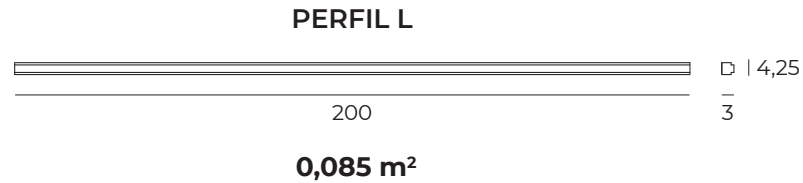

*PARA COMBINAR CON NUESTROS PANELES / *TO COMBINE WITH OUR PANELS

Acabado de Colores / Finished Colours



*Ver especificaciones de acabados: página 16-17 /
*See finish specifications: page 16-17

CALIDADES / QUALITIES	REFERENCIA / CODE	DESCRIPCIÓN / DESCRIPTION	KG.			PVP € UNIDAD / PRICE € UNIT
	LX-PLL	Perfil L Liso / Plain	LX: -	LX: -	LX: -	-
	LX-PML	Perfil M Liso / Plain	LX: -	LX: -	LX: -	-
	PR-PLC	Perfil L Cemento / Concrete	PR: -	PR: -	PR: -	-
	PR-PMC	Perfil M Cemento / Concrete	PR: -	PR: -	PR: -	-

Kg., embalaje y palé pueden variar +/- / Kg., packaging and pallet may vary +/-

Información Técnica

Technical Information

PANELPIEDRA® se reserva el derecho a cambiar los modelos, colores, tamaños, envases y cajas sin previo aviso.

Todos los pesos y dimensiones mencionadas son en cm y se muestran con la mayor precisión posible, pero pueden diferir hasta 2% por la expansión y la contracción durante la producción.

Las fotografías de este Catálogo se crean en lugares del proyecto y en estudios, algunos incluso podrían ser infografías. Las diferencias en la exposición de la luz y la impresión en papel pueden causar que los productos y los colores se vea diferente que en la realidad. Para verificar acabados y texturas utilicen el Servicio de Muestras.

PANELPIEDRA® reserves the right to change models, colours, sizes, packaging and boxes without prior notice.

All weights and dimensions mentioned are in centimetres and are shown as accurately as possible but may differ up to 2% +/- due to expansion and contraction during production.

The photographs in this Catalogue are created on project sites and in studios, some could even be infographics. Differences in light exposure and printing on paper may cause products and colours to appear different than the real thing. To check finishes and textures use the Samples Service.

SÍMBOLOS UTILIZADOS EN ESTE CATÁLOGO / SYMBOLS USED IN THE CATALOGUE



UNIDADES POR CAJA
UNITS PER BOX



UNIDADES POR PALÉ
UNITS PER PALLET



POLIURETANO+PIEDRA
POLYURETHANE+STONE



PIEDRA ALIGERADA
STONE LIGHT

Garantía

Warranty



Esta garantía cubre las posibles deficiencias o problemas del producto ocasionadas por mala fabricación o materiales defectuosos. Esta garantía no cubre todas aquellas deficiencias o problemas ocasionados por negligencias derivadas de su uso o instalación, así como los daños y perjuicios que estos pudieran ocasionar. Esta garantía no cubre la mano de obra o desplazamiento en caso de negligencias derivadas de su uso o instalación. En caso de incidencia, deberá aportar en el establecimiento de compra acompañado de nuestra garantía, la factura de compra original junto con imágenes descriptivas de la incidencia.

PANELPIEDRA® pone a su disposición en caso de requerimiento, todos los ensayos UNE 1427:2006 y AI:2010.

This guarantee covers possible product deficiencies or problems caused by poor manufacturing or materials. This guarantee does not cover all those deficiencies or problems caused by negligence derived from its use or installation, as well as the damages that these could cause. This guarantee does not cover labour or displacement in case of negligence derived from its use or installation. In the event of an incident, you must provide the original purchase invoice together with descriptive images of the incident at the purchase establishment accompanied by this guarantee.

PANELPIEDRA® puts at your disposal in case of requirement, all tests UNE 1427:2006 and AI:2010.

Condiciones de venta

Sales Terms

PEDIDOS

Todos los pedidos deberán ser por escrito (Correo electrónico o mediante nuestro delegado comercial). Las anulaciones o variaciones de pedidos no se admitirán una vez que éstos hayan entrado en fabricación.

TARIFA

Esta tarifa anula a las anteriores, los precios están sujetos a posibles variaciones motivados por cambio de precios de materias primas, situaciones de mercado etc.

DESCUENTOS

Se realizará el % correspondiente en toda la tarifa.

PEDIDO MÍNIMOS

Los pedidos mínimos serán de 60 euros y siempre se remitirán a portes debidos.

FORMAS DE PAGO

El pago en el primer pedido se realizará al contado anticipado por transferencia bancaria (No se admitirán excepciones).

En los siguientes pedidos la financiación se realizará mediante giro bancario (siempre sujeto a los informes financieros remitidos por nuestro departamento financiero y siempre respetando el plazo que establece la ley de morosidad).

VARIOS GIROS

No se fraccionará los giros inferiores a 500 euros.

PORTES

El Importe del Coste del Transporte de todos los Pedidos de Península y Baleares irán siempre por cuenta del cliente sea cual sea el importe del Pedido. No se establece pedido mínimo.

DEVOLUCIONES DE MATERIAL

No se admitirán devoluciones sin acuerdo previo y consentimiento de fábrica. Cualquier incidencia en la entrega de la mercancía rogamos lo hagan constar en la PDA del Transporte y en el Albarán, de no ser así dispone de un plazo de 24 horas para hacer efectiva la reclamación. No se admitirán devoluciones por sobrantes de material, por errores elección de color o modelo y en ningún caso después de los 30 días naturales de su entrega.

ORDERS

All orders must be sent in writing (Email or through our sales representative). Cancellations or variations of orders will not be accepted once they have entered production.

RATE

This rate cancels the previous ones, the prices are subject to possible variations motivated by changes in the prices of raw materials, market situations, etc.

DISCOUNTS

The corresponding percentage (%) will be made in the entire rate.

MINIMUM ORDER

The minimum orders will be 60 euros and will always be ex-works.

PAYMENT METHODS

Payment in the first order will be made in advance at order by bank transfer (no exceptions will be accepted).

The following orders to be paid before departure of the goods or upon receipt, but only if granted by our financial department in advance and always respecting the term established by the delinquency law).

VARIOUS GIROS

Spanish giros of less than 500 euros will not be split.

POSTAGE

The cost of transport will always be borne by the customer whatever the amount of the order. No minimum qty is required.

MATERIAL RETURNS

Returns will not be accepted without prior agreement and factory consent. Any incident in the delivery of the merchandise, please advise on the delivery note of the transport, otherwise you have a period of 24 hours to make the claim effective. Returns will not be accepted due to excess material, colour or model selection errors and in no case after 30 calendar days of delivery. No claims will be accepted on materials already installed.



PANELPIEDRA®
S I N C E 1 9 7 4

Polígono Industrial Municipal
Vial Transversal, 2
31500 Tudela (Navarra) Spain
Tlf: +34 941 181 091

www.panelpiedra.com





PANELPIEDRA®
SINCE 1974

Decorative Panels
Passion for Quality



PANELPIEDRA®
S I N C E 1 9 7 4

Decorative Panels

Passion for Quality

PANELPIEDRA®





NUESTRA EMPRESA OUR COMPANY	4 - 11
PRODUCTO PRODUCT	12
VENTAJAS ADVANTAGES	13
INFORMACIÓN TÉCNICA TECHINICAL INFORMATION	14
GARANTÍA WARRANTY	14
CONDICIONES DE VENTA SALES TERM	15
FOREST COLLECTION	16 - 43
CEMENT COLLECTION	44 - 93
VINTAGE COLLECTION	94 - 129
BRICK COLLECTION	130 - 177
REMEMBER COLLECTION	178 - 199
LIFESTYLE COLLECTION	200 - 227
CLASSIC COLLECTION	228 - 335
MARKETING MARKETING	336 - 349
DATOS TÉCNICOS	350 - 361
PROYECTOS A MEDIDA Y PARTNERS BESPOKE PRODUCTS AND PARTNERS	362

NUESTRA EMPRESA

Our Company

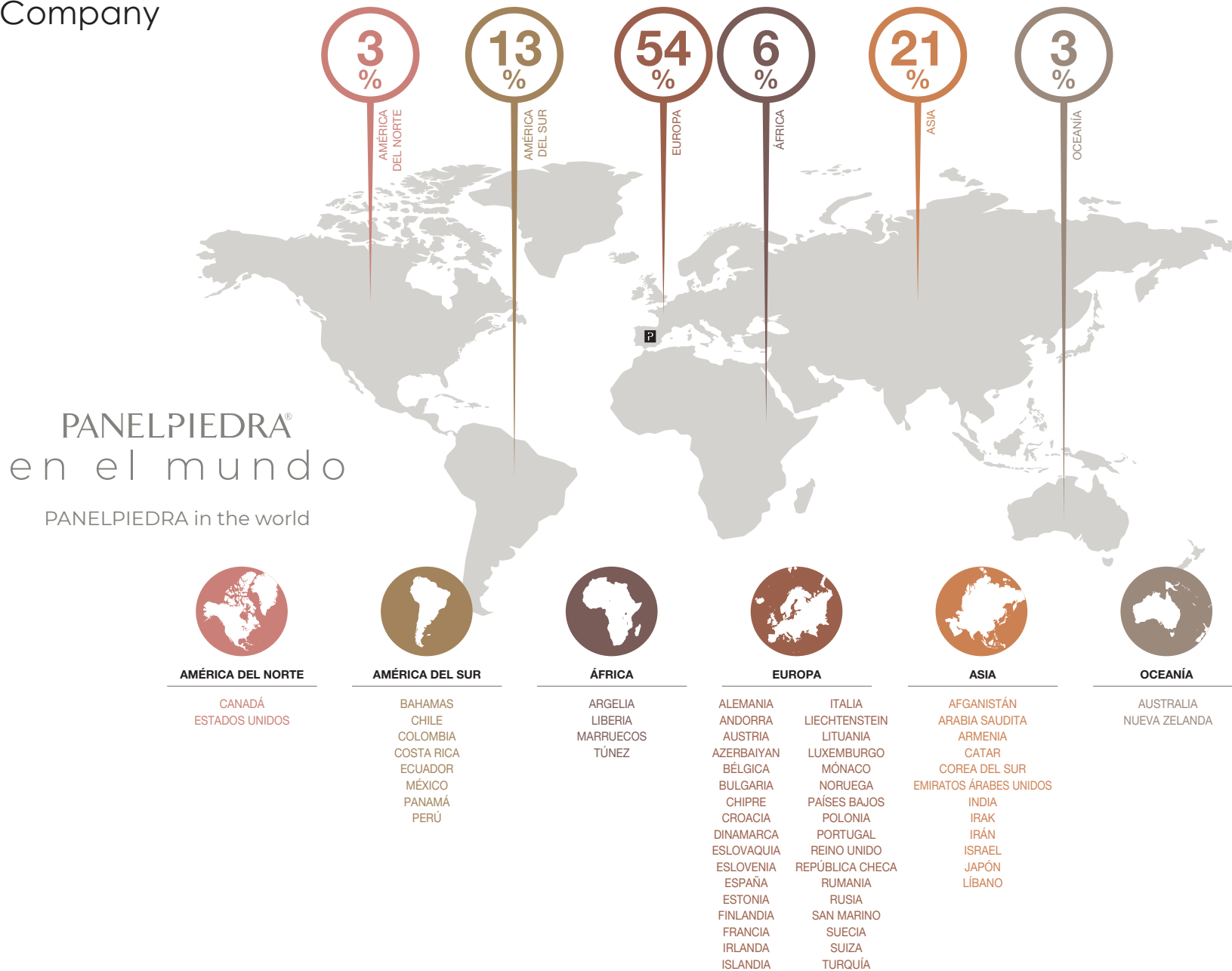

En sus 50 años de trayectoria Paneles Decorativos Panel Piedra ha centrado sus esfuerzos en ofrecer un producto de calidad y diseño claramente orientado a satisfacer las necesidades del cliente. Gracias al esfuerzo de todos estos años y a una acertada gestión empresarial, PANELPIEDRA® está presente en más de 60 países de Europa, América y Asia. Actualmente, su misión es crear espacios que contribuyan al bienestar a través del diseño, la funcionalidad y las tecnologías revestimiento.

Su estrategia está fuertemente marcada por la innovación dirigida tanto al producto como a la gestión de la empresa. Su objetivo es seguir imprimiendo un alto valor añadido que le permita la diferenciación con la competencia en los distintos mercados, y contribuir a mejorar la calidad de vida de sus clientes. La historia de esta empresa es la de la superación, el esfuerzo, la confianza y el trabajo en equipo. En todos estos años ha ido evolucionando paso a paso hasta llegar al punto de liderazgo que hoy ostenta PANELPIEDRA®.

In its 50 years of trajectory Paneles Decorativos Panel Piedra has always focused its efforts on offering a quality product and design, clearly oriented to satisfy customer needs. Thanks to the efforts of all these years and successful business management, PANELPIEDRA® is available in more than 60 countries in Europe, America and Asia. Currently, its mission is to create spaces that contribute to well-being through design, functionality and cladding technologies.

Its strategy is strongly marked by innovation directed both to the product and to the management of the company. Its objective is to continue to manufacture a high added value that allows it to differentiate itself from the competition in different markets and to contribute to improving the quality of life of its customers. The history of this company is one of fortuitous, effort, trust and teamwork. In all these years it has evolved step by step to reach the point of leadership that PANELPIEDRA® holds today.



PANELES DECORATIVOS
PANELPIEDRA S.L.
Polígono Industrial Municipa
Vial Transversal, 2
31500 TUDELA (NAVARRA) SPAIN
T. +34 941 18 10 91
www.panelpiedra.com



PANELPIEDRA® dispone de un gran centro de fabricación en Tudela, Navarra, España. Con modernas y preparadas instalaciones de 170.000 m².

PANELPIEDRA® have a large manufacturing center in Tudela, Navarra, Spain With modern and prepared facilities of 170.000 m².



NUESTRAS INSTALACIONES

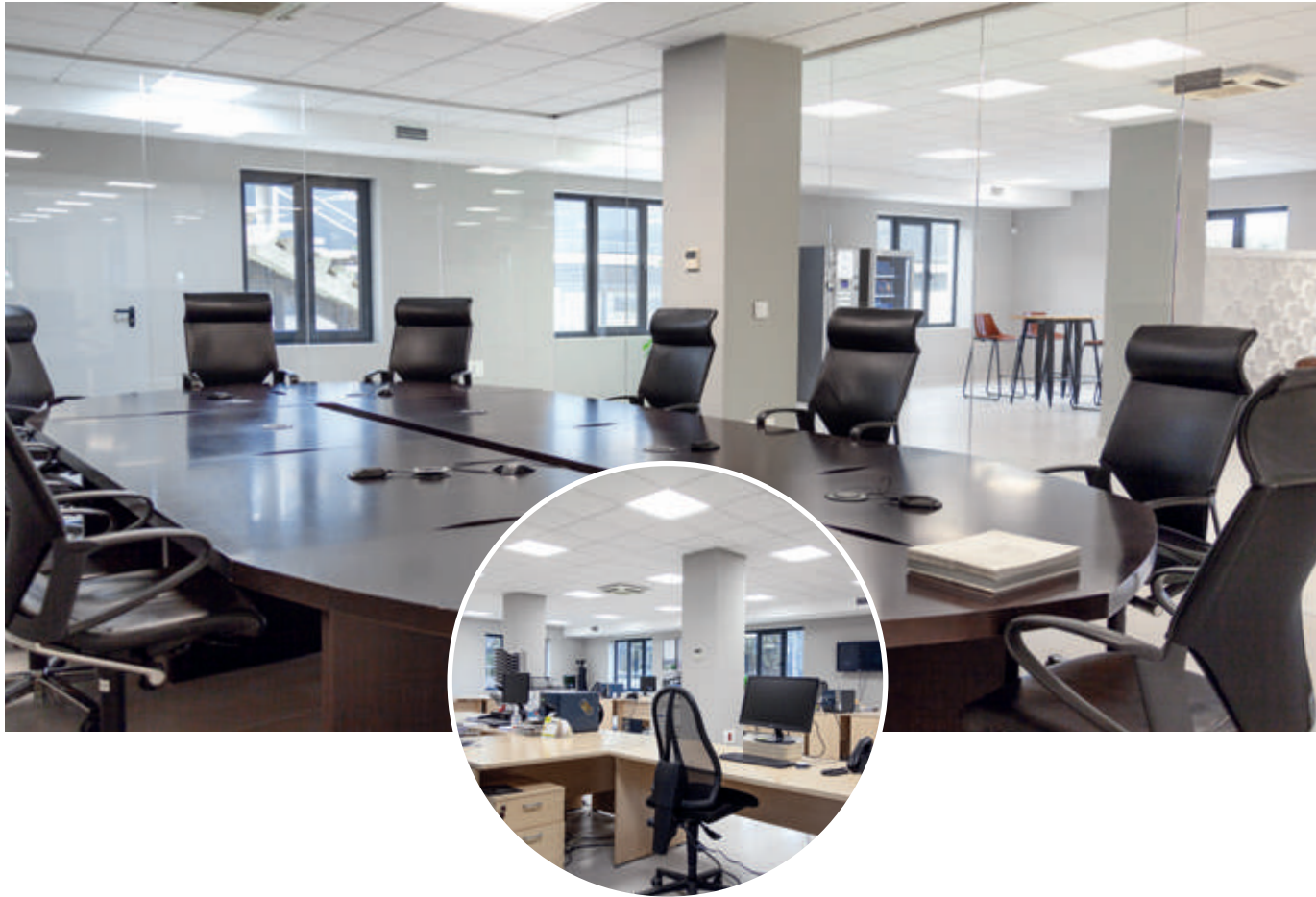

Facilities

OFICINAS

1.865 m2 de modernas oficinas y espacio expositivo, con una división perfectamente departamentada para ofrecer la mejor atención a los 52 países donde tenemos presencia comercial.

OFFICES

1865 Sqm of offices and Showroom in order to offer the best possible customer service to all our clients, spread across 52 countries.



EXPOSICIÓN

Con más de 200 m² destinados a la exhibición de nuestros paneles de revestimientos y de mobiliario de baño.

EXHIBITION

With more than 200 m² destined to the exhibition of our cladding tiles and bathroom furniture products.



LAB E INGENIERÍA

Todos nuestros productos y materiales pasan un exhaustivo control de calidad en nuestros laboratorios, todo ello es precedido por una amplia labor de investigación y desarrollo llevada a cabo por el Departamento de Ingeniería, donde se trabaja para alcanzar los estándares de calidad e innovación que caracterizan nuestra marca PANELPIEDRA®

LAB AND ENGINEERING

All our products and materials pass an exhaustive quality control in our laboratories, all this is preceded by extensive research and development carried out by the Engineering Department, where we work to achieve the quality and innovation standards that characterize our PANELPIEDRA® brand.

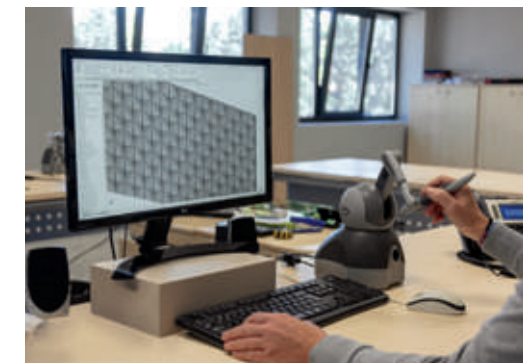



PRODUCCIÓN

Miles de metros cuadrados de industria, dedicados a la fabricación de paneles decorativos para interior y exterior, mobiliario de baño, platos de ducha y lavabos (solid surface). Con zonas de modelado, de mezclas, de producción, de acabados, de secado y de inspección de calidad. Todo preparado para que nuestro proceso de producción sea eficaz y de alta calidad.

PRODUCTION

Thousands of sqm of manufacturing capacity with different departments for moulding, mixing, manufacturing, finishing, drying and quality inspection. With the purpose of producing our products (wall covering panels for interior and exterior, bathroom furniture, shower trays, solid surface).

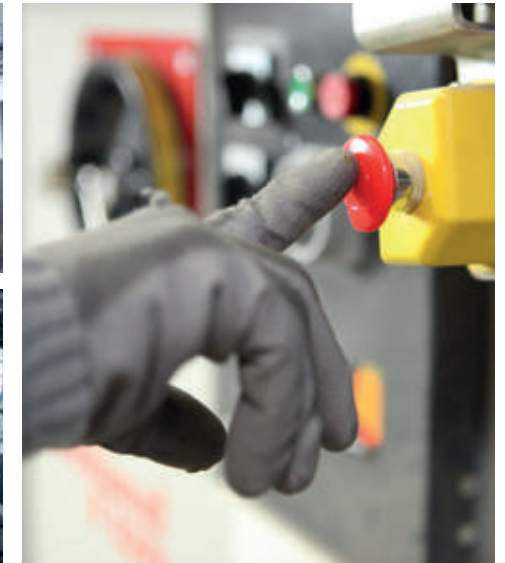

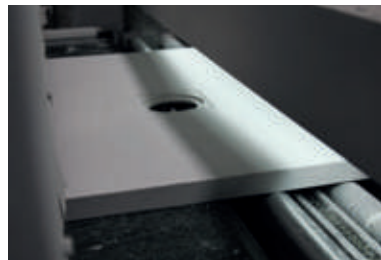
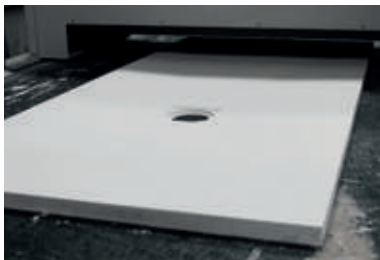
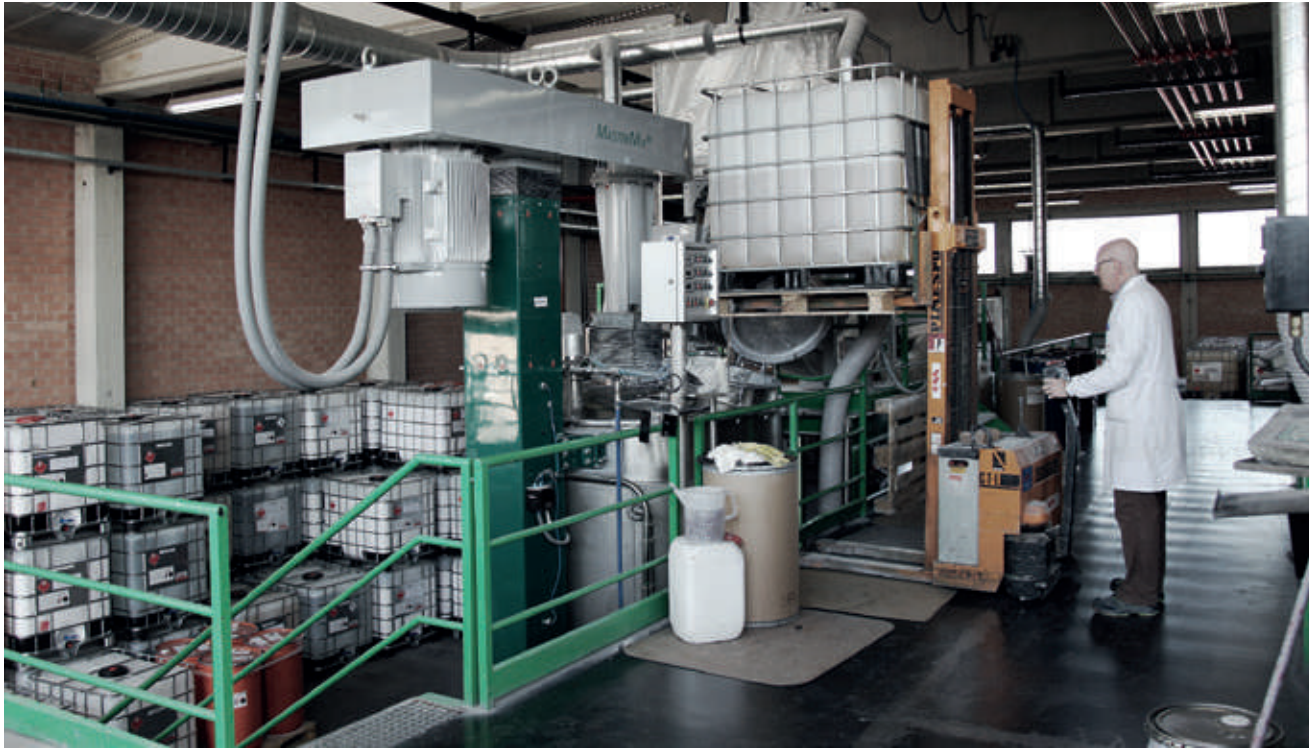

ZONA DE EMBALAJE Y ALMACÉN

Una gran organización de nuestros productos, tanto en el embalaje como en el almacenaje, hacen que nuestros pedidos tengan un seguimiento continuo de calidad hasta su entrega.

PACKING & STORAGE AREA

A well organised packing and storage area in order to have a great follow up of clients' orders and keepup the high quality until delivery.



PRODUCTO

Product

Nuestra dedicación constante a la investigación tecnológica nos ha permitido desarrollar un producto perfecto y vanguardista en un campo en constante evolución, como es el mundo de la decoración y el diseño.

Ofrecemos las mejores soluciones estéticas para las últimas tendencias en diseño e interiorismo, cada vez más iconoclasta en la combinación de formas, colores y materiales.

Nuestros sistemas de fabricación patentados nos permiten una reproducción fiel de texturas y tonos de piedras, ladrillos, cementos y maderas, pero además la facilidad de instalación, resistencia y calidad convierten a nuestro producto en uno de los más demandados por los profesionales del sector.

La utilización de los productos PANELPIEDRA® permite crear ambientes que combinan elegancia, diseño y calidad.

Our ongoing commitment to technological research allowed us to develop a cutting edge product within a constantly evolving industry, as it is the world of decoration and design.

We offer the best aesthetic solutions for the latest trends in interior design and, increasingly iconoclastic combination of shapes, colors and materials.

Our patented manufacturing systems allow us to faithfully reproduce textures and colors of stones, bricks cement and woods. The easy installation, strength and high quality of our products, makes them highly demanded by professionals.

The use of PANELPIEDRA® products allow customers to create atmospheres that combine elegance, quality and design.



PR: Panel de poliuretano con piedra.

Panel compuesto por una capa de 4 mm. (aprox.) de polvo de mármol (piedra) y una capa de inyección de poliuretano de alta densidad.

Todo ello hace que sea muy resistente a todo tipo de inclemencias climatológicas (lluvia, sol, heladas, niebla, salina, etc.) Es apto para su colocación en interior y en exterior. Excelentes propiedades saliente térmicas, acústicas y anti-humedad.

HD®: Panel High Definition.

HD® es un producto innovador para revestimientos de todo tipo de paredes, muros y techos, compuesto con más de 16 tipos de cargas, minerales y químicas (piedra, mármol, sílices, silicatos, etc.) que lo hacen muy resistentes al exterior, al fuego y todo tipo de inclemencias climatológicas en el tiempo, como a su vez gran resistencia a la abrasión y productos químicos. También goza de una gran cualidad que es su bajo peso y su alto volumen, que todo ello hace que sea muy fácil su colocación. Es muy apto para lugares públicos de gran tránsito de personas, fachadas y grandes construcciones, lugares con mucha humedad, saunas, etc.

Excelentes propiedades ignífugas, hidrófugas, su inalterabilidad al choque térmico y a sus ciclos de hielo y deshielo, su nulo porcentaje de absorción de agua garantiza su completa estanqueidad, su alta resistencia a la mayoría de productos químicos, junto con su mínimo desgaste por abrasión, hacen que el producto HD® sea un material de alta calidad.

PR: Polyurethane and stone panel.

Panel composed of a layer of approximately 4 mm of crushed marble stone and a layer of high density injected polyurethane. These components makes it very resistant to all kinds of weather conditions (rain, sun, frost, fog, salt, etc.). Suitable for indoors and outdoors installations. Excellent thermal, acoustic and anti-humidity characteristics.

HD®: High Definition Panel.

HD® is a highly innovative panel for coating all types of walls and ceilings. It is made out of more than 16 types of mineral and chemical charges (ie: stone, marble, silica, silicates, etc.). This composition makes the panel suitable to exteriors, resistant to fire and all kind of weather. Also, it has great resistance to abrasion and chemicals. Its low weight and large size makes the installation very quick and easy. Suitable for public places and areas of high traffic of people, facades, large buildings, places with high humidity (ie: saunas), etc.

Excellent fire retardant, water repellent, resistant to heat, freeze and defrost. Its zero percent water absorption ensures a complete sealing. High resistance to most chemicals products and low abrasive wear. All these characteristics make HD® panel a high quality material

VENTAJAS

Advantages

- El panel más ligero del mercado.
- Instalación más fácil y sencilla.
- Paneles de colocación rápida.
- Importante ahorro en costes.
- Acabado perfecto.
- No necesita mantenimiento.
- Excelente aislamiento acústico.
- Buen aislamiento térmico y anti-humedad.
- Excelentes propiedades ignífugas.
- Excelente repelencia al agua.
- No se altera con el calor, el frío o la congelación.
- Material impermeable.
- Mínima abrasión.
- Alta resistencia a la mayoría de los productos químicos.
- Elegantes combinaciones de materiales y diseños.
- Facilidad de transporte y manejo

- The lightest panel in the market.
- Easy and simple installation.
- Quick installation system.
- Cost savings in labor.
- Perfect finish.
- Does not require maintenance
- Excellent soundproof qualities.
- Good thermal insulation and anti-humidity.
- Excellent flame retardant properties.
- Excellent water-repellent.
- No mutation to heat, freeze and defrost.
- Not permeable.
- Minimum abrasion.
- High resistance to most chemicals.
- Elegant combinations of materials and designs.
- Ease of transport and handling.



INFORMACIÓN TÉCNICA

Technical Information

PANELPIEDRA® se reserva el derecho a cambiar los modelos, colores, tamaños, envases y cajas sin previo aviso.

Todos los pesos y dimensiones mencionadas son en cm y se muestran con la mayor precisión posible, pero pueden diferir hasta 2% por la expansión y la contracción durante la producción.

Las fotografías de este Catálogo se crean en lugares del proyecto y en estudios, algunos incluso podrían ser infografías. Las diferencias en la exposición de la luz y la impresión en papel pueden causar que los productos y los colores se vea diferente que en la realidad. Para verificar acabados y texturas utilicen el Servicio de Muestras.

PANELPIEDRA® reserves the right to change models, colours, sizes, packaging and boxes without prior notice.

All weights and dimensions mentioned are in centimetres and are shown as accurately as possible but may differ up to 2% +/- due to expansion and contraction during production.

The photographs in this Catalogue are created on project sites and in studios, some could even be infographics. Differences in light exposure and printing on paper may cause products and colours to appear different than the real thing. To check finishes and textures use the Samples Service.

Símbolos utilizados en la tarifa / Symbols used in the rate/pricing



CÓDIGO
CODE



PESO (KG.)
WEIGHT (KG.)



CÓDIGO EAN
BARCODE EAN



UNIDADES POR CAJA
UNITS PER BOX



TEXTURA
TEXTURE

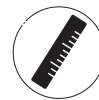

MEDIDA
MEASURE



UNIDADES POR PALÉ
UNITS PER PALLET



POLIURETANO+PIEDRA
POLYURETHANE+STONE



PIEDRA
STONE

GARANTÍA

Warranty

Esta garantía cubre las posibles deficiencias o problemas del producto ocasionadas por mala fabricación o materiales defectuosos. Esta garantía no cubre todas aquellas deficiencias o problemas ocasionados por negligencias derivadas de su uso o instalación, así como los daños y perjuicios que estos pudieran ocasionar.

Esta garantía no cubre la mano de obra o desplazamiento en caso de negligencias derivadas de su uso o instalación.

En caso de incidencia, deberá aportar en el establecimiento de compra acompañado de nuestra garantía, la factura de compra original junto con imágenes descriptivas de la incidencia.

PANELPIEDRA® pone a su disposición en caso de requerimiento, todos los ensayos UNE 1427:2006 y A1:2010.

This guarantee covers possible product deficiencies or problems caused by poor manufacturing or materials. This guarantee does not cover all those deficiencies or problems caused by negligence derived from its use or installation, as well as the damages that these could cause.

This guarantee does not cover labour or displacement in case of negligence derived from its use or installation.

In the event of an incident, you must provide the original purchase invoice together with descriptive images of the incident at the purchase establishment accompanied by this guarantee.

PANELPIEDRA® puts at your disposal in case of requirement, all tests UNE 1427:2006 and A1:2010.

CONDICIONES DE VENTA

Sales Terms

PEDIDOS

Todos los pedidos deberán ser por escrito (Correo electrónico o mediante nuestro delegado comercial).

Las anulaciones o variaciones de pedidos no se admitirán una vez que éstos hayan entrado en fabricación.

TARIFA

Esta tarifa anula a las anteriores, los precios están sujetos a posibles variaciones motivados por cambio de precios de materias primas, situaciones de mercado etc.

DESCUENTOS

Se realizará el % correspondiente en toda la tarifa.

PEDIDO MÍNIMOS

Los pedidos mínimos serán de 60 euros y siempre se remitirán a portes debidos.

FORMAS DE PAGO

El pago en el primer pedido se realizará al contado anticipado por transferencia bancaria (No se admitirán excepciones).

En los siguientes pedidos la financiación se realizará mediante giro bancario (siempre sujeto a los informes financieros remitidos por nuestro departamento financiero y siempre respetando el plazo que establece la ley de morosidad).

VARIOS GIROS

No se fraccionará los giros inferiores a 500 euros.

PORTES

El Importe del Coste del Transporte de todos los Pedidos de Península y Baleares irán siempre por cuenta del cliente sea cual sea el importe del Pedido. No se establece pedido mínimo.

DEVOLUCIONES DE MATERIAL

No se admitirán devoluciones sin acuerdo previo y consentimiento de fábrica. Cualquier incidencia en la entrega de la mercancía rogamos lo hagan constar en la PDA del Transporte y en el Albarán, de no ser así dispone de un plazo de 24 horas para hacer efectiva la reclamación. No se admitirán devoluciones por sobrantes de material, por errores elección de color o modelo y en ningún caso después de los 30 días naturales de su entrega.

ORDERS

All orders must be sent in writing (Email or through our sales representative).

Cancellations or variations of orders will not be accepted once they have entered production.

RATE

This rate cancels the previous ones, the prices are subject to possible variations motivated by changes in the prices of raw materials, market situations, etc.

DISCOUNTS

The corresponding percentage (%) will be made in the entire rate.

MINIMUM ORDER

The minimum orders will be 60 euros and will always be ex-works.

PAYMENT METHODS

Payment in the first order will be made in advance at order by bank transfer (no exceptions will be accepted).

The following orders to be paid before departure of the goods or upon receipt, but only if granted by our financial department in advance and always respecting the term established by the delinquency law).

VARIOUS GIROS

Spanish giros of less than 500 euros will not be split.

POSTAGE

The cost of transport will always be borne by the customer whatever the amount of the order. No minimum qty is required.

MATERIAL RETURNS

Returns will not be accepted without prior agreement and factory consent. Any incident in the delivery of the merchandise, please advise on the delivery note of the transport, otherwise you have a period of 24 hours to make the claim effective. Returns will not be accepted due to excess material, colour or model selection errors and in no case after 30 calendar days of delivery. No claims will be accepted on materials already installed.



FOREST[®]

Collection



FOREST[®]

Collection



ALFA / 20-25



RUSTIC / 26-31



BALEARIA / 32-37



LUMBIER / 38-43

Forest ALFA[®]

(2023 Patented Design©)

PANELPIEDRA[®]

PR



PR-864 Alfa Marrón



PR-864 Alfa Marrón

PR-864 Alfa Marrón

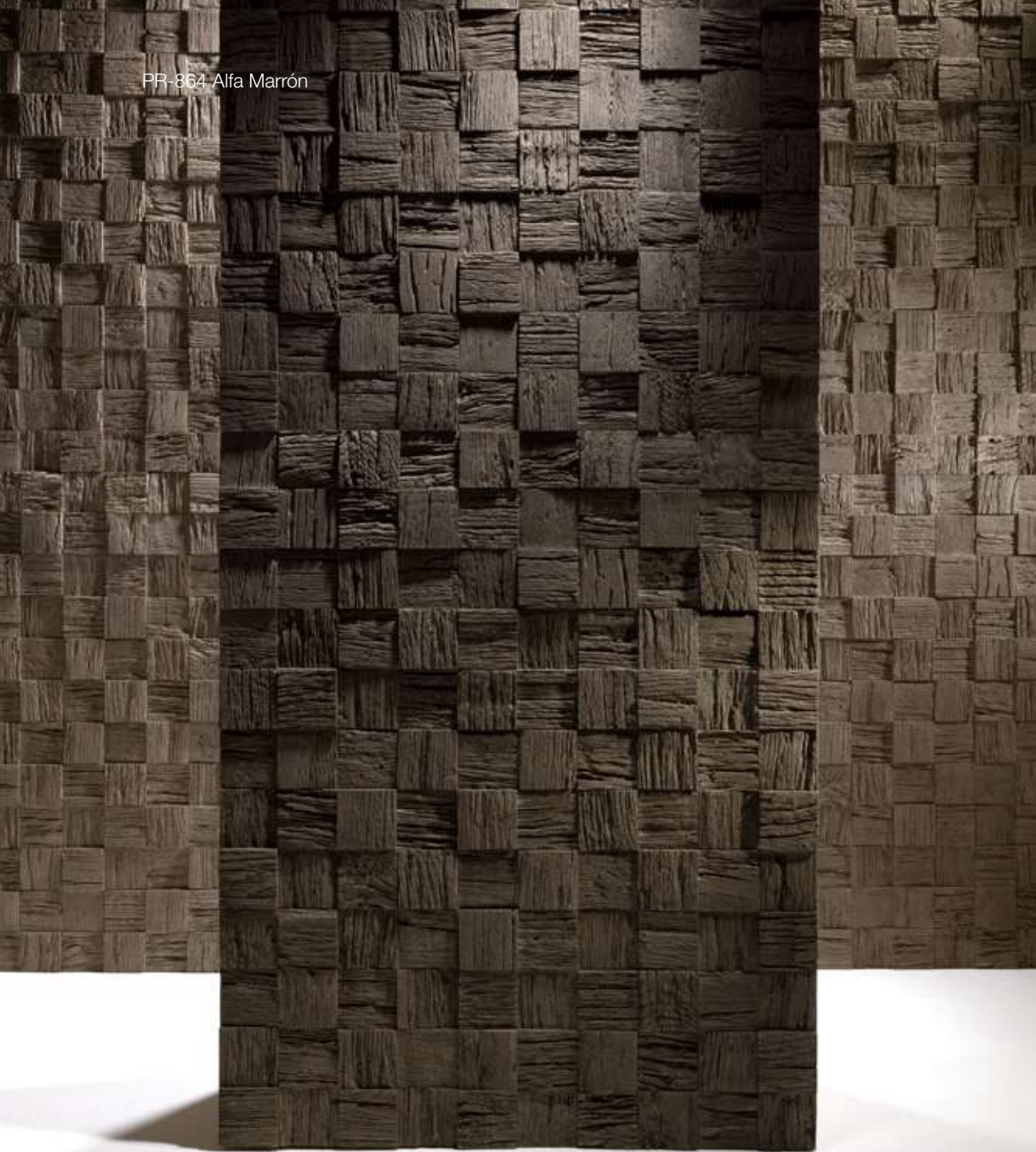



PR-865 Alfa Marrón Arena



PR-866 Alfa Marrón Viejo

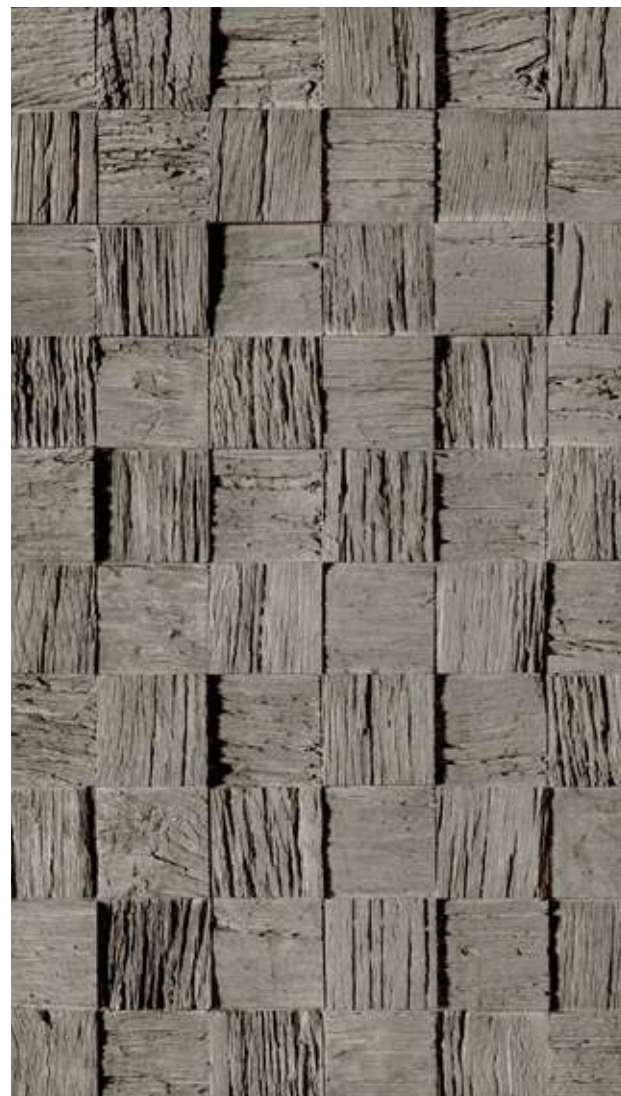

PR-867 Alfa Gris Viejo



PR-865 Alfa Marrón Arena

ACABADOS / FINISHES

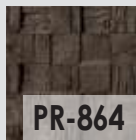

PR-864

Alfa Marrón /
Alfa Brown

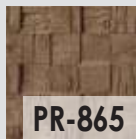

PR-865

Alfa Marrón Arena /
Alfa Sandy Brown



PR-866

Alfa Marrón Viejo /
Alfa Old Brown

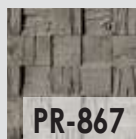

PR-867

Alfa Gris Viejo /
Alfa Old Grey

MEDIDAS / MEASUREMENTS

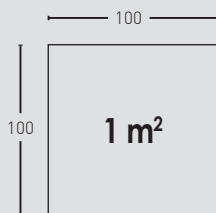

3 mín
5 máx.

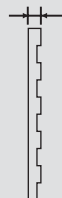

PRODUCTO PRODUCT	COD.	DESCRIPCIÓN DESCRIPTION				PR
	PR-864	Panel Alfa Marrón	PR: 8 kg	PR: --	PR: --	€/unidad -

Complementos necesarios para la instalación / Necessary materials for installation **Rendimiento Aprox. / Average Usage** **Precio / Price**

	<input type="checkbox"/> MSA-70 Masilla Juntas Blanco Italia	1 Cartucho 2 Panel	-
	<input checked="" type="checkbox"/> PTX-88 Pintura Difuminador Marrón	1 Bote 8 Paneles	-
	<input checked="" type="checkbox"/> PTE-44 Pintura Glaseador Marrón	1 Bote 15 Paneles	-

Complementos opcionales para la instalación / Optional materials for installation **Rendimiento Aprox. / Average Usage** **Precio / Price**

<input type="checkbox"/> MSA-3-280 Masilla de Pegado	1 Cartucho 4 Paneles	-
--	----------------------	---

PRODUCTO PRODUCT	COD.	DESCRIPCIÓN DESCRIPTION				PR
	PR-865	Panel Alfa Marrón Arena	PR: 8 kg	PR: --	PR: --	€/unidad -

Complementos necesarios para la instalación / Necessary materials for installation **Rendimiento Aprox. / Average Usage** **Precio / Price**

	<input type="checkbox"/> MSA-70 Masilla Juntas Blanco Italia	1 Cartucho 2 Panel	-
	<input checked="" type="checkbox"/> PTX-91 Pintura Difuminador Marrón Arena	1 Bote 8 Paneles	-
	<input checked="" type="checkbox"/> PTE-47 Pintura Glaseador Marrón Arena	1 Bote 15 Paneles	-

Complementos opcionales para la instalación / Optional materials for installation **Rendimiento Aprox. / Average Usage** **Precio / Price**

<input type="checkbox"/> MSA-3-280 Masilla de Pegado	1 Cartucho 4 Paneles	-
--	----------------------	---

PRODUCTO PRODUCT	COD.	DESCRIPCIÓN DESCRIPTION				PR
	PR-866	Panel Alfa Marrón Viejo	PR: 8 kg	PR: --	PR: --	€/unidad -

Complementos necesarios para la instalación / Necessary materials for installation **Rendimiento Aprox. / Average Usage** **Precio / Price**

	<input type="checkbox"/> MSA-70 Masilla Juntas Blanco Italia	1 Cartucho 2 Panel	-
	<input checked="" type="checkbox"/> PTX-89 Pintura Difuminador Marrón Viejo	1 Bote 8 Paneles	-

Complementos opcionales para la instalación / Optional materials for installation **Rendimiento Aprox. / Average Usage** **Precio / Price**

<input type="checkbox"/> MSA-3-280 Masilla de Pegado	1 Cartucho 4 Paneles	-
--	----------------------	---

PRODUCTO PRODUCT	COD.	DESCRIPCIÓN DESCRIPTION				PR
	PR-867	Panel Alfa Gris Viejo	PR: 8 kg	PR: --	PR: --	€/unidad -

Complementos necesarios para la instalación / Necessary materials for installation **Rendimiento Aprox. / Average Usage** **Precio / Price**

	<input type="checkbox"/> MSA-70 Masilla Juntas Blanco Italia	1 Cartucho 2 Panel	-
	<input checked="" type="checkbox"/> PTX-89 Pintura Difuminador Marrón Viejo	1 Bote 8 Paneles	-
	<input checked="" type="checkbox"/> PTE-48 Pintura Glaseador Gris Viejo	1 Bote 15 Paneles	-

Complementos opcionales para la instalación / Optional materials for installation **Rendimiento Aprox. / Average Usage** **Precio / Price**

<input type="checkbox"/> MSA-3-280 Masilla de Pegado	1 Cartucho 4 Paneles	-
--	----------------------	---

Forest RUSTIC®

(2022 Patented Design©)

PANELPIEDRA®

PR



PR 863 Gris Viejo



PR 863 Gris Viejo

PR 861 Marrón Arena



PR 861 Marrón Arena



PR 860 Marrón



PR 862 Marrón Viejo

Forest RUSTIC

ACABADOS / FINISHES

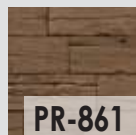
Marrón /
BrownMarrón Arena /
Sandy BrownMarrón Viejo /
Old BrownGris Viejo /
Old Grey

MEDIDAS / MEASUREMENTS

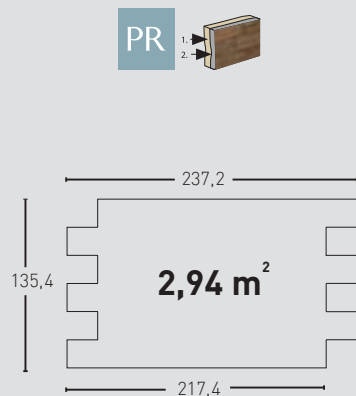
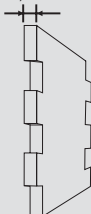
3 mín.
3,5 máx.

Las medidas pueden variar +/- 1cm / Measurements may vary +/- 1cm

PRODUCTO PRODUCT	COD.	DESCRIPCIÓN DESCRIPTION	KG			PR
PR	PR-860	Panel Rustic Marrón	PR: 25,5 kg	PR: --	PR: --	€/unidad -
Complementos necesarios para la instalación / Necessary materials for installation			Rendimiento Aprox. / Average Usage		Precio / Price	
			○ MSA-70 Masilla Juntas Blanco Italia ● PTX-88 Pintura Difuminador Marrón ● PTE-44 Pintura Glaseador Marrón	1 Cartucho 1 Panel 1 Pintura 5 Paneles 1 Pintura 5 Paneles	- - -	
Complementos opcionales para la instalación / Optional materials for installation			Rendimiento Aprox. / Average Usage		Precio / Price	
○ MSA-3 Masilla de Pegado			1 Cartucho 2 Paneles		-	
PRODUCTO PRODUCT	COD.	DESCRIPCIÓN DESCRIPTION	KG			PR
PR	PR-861	Panel Rustic Marrón Arena	PR: 25,5 kg	PR: --	PR: --	€/unidad -
Complementos necesarios para la instalación / Necessary materials for installation			Rendimiento Aprox. / Average Usage		Precio / Price	
			○ MSA-70 Masilla Juntas Blanco Italia ● PTX-91 Pintura Difuminador Marrón Arena ● PTE-47 Pintura Glaseador Marrón Arena	1 Cartucho 1 Panel 1 Pintura 5 Paneles 1 Pintura 5 Paneles	- - -	
Complementos opcionales para la instalación / Optional materials for installation			Rendimiento Aprox. / Average Usage		Precio / Price	
○ MSA-3 Masilla de Pegado			1 Cartucho 2 Paneles		-	
PRODUCTO PRODUCT	COD.	DESCRIPCIÓN DESCRIPTION	KG			PR
PR	PR-862	Panel Rustic Marrón Viejo	PR: 25,5 kg	PR: --	PR: --	€/unidad -
Complementos necesarios para la instalación / Necessary materials for installation			Rendimiento Aprox. / Average Usage		Precio / Price	
			○ MSA-70 Masilla Juntas Blanco Italia ● PTX-89 Pintura Difuminador Marrón Viejo	1 Cartucho 1 Panel 1 Pintura 5 Paneles	- -	
Complementos opcionales para la instalación / Optional materials for installation			Rendimiento Aprox. / Average Usage		Precio / Price	
○ MSA-3 Masilla de Pegado			1 Cartucho 2 Paneles		-	
PRODUCTO PRODUCT	COD.	DESCRIPCIÓN DESCRIPTION	KG			PR
PR	PR-863	Panel Rustic Gris Viejo	PR: 25,5 kg	PR: --	PR: --	€/unidad -
Complementos necesarios para la instalación / Necessary materials for installation			Rendimiento Aprox. / Average Usage		Precio / Price	
			○ MSA-70 Masilla Juntas Blanco Italia ● PTX-89 Pintura Difuminador Marrón Viejo ● PTE-48 Pintura Glaseador Gris Viejo	1 Cartucho 1 Panel 1 Pintura 5 Paneles 1 Pintura 5 Paneles	- - -	
Complementos opcionales para la instalación / Optional materials for installation			Rendimiento Aprox. / Average Usage		Precio / Price	
○ MSA-3 Masilla de Pegado			1 Cartucho 2 Paneles		-	

Forest BALEARIA®

(2022 Patented Design©)

PANELPIEDRA®

PR



PR 883 Gris Pátina



PR 881 Marrón Viejo



PR 883 Gris Pátina

34 PANELPIEDRA



PR 880 Marrón



PR 881 Marrón Viejo



PR 882 Marrón Pátina



PR 883 Gris Pátina



PR 884 Azul Pátina



PR 885 Rosa Pátina

Forest BALEARIA

ACABADOS / FINISHES

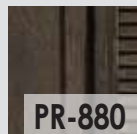

Marrón /
Brown



Marrón Viejo /
Old Brown



Marrón Pátina /
Patina Brown



Gris Pátina /
Patina Grey

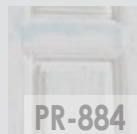

Azul Pátina /
Patina Blue



Rosa Pátina /
Patina Pink

MEDIDAS / MEASUREMENTS

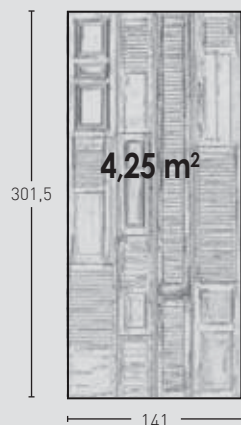

2,5 mín.
4,5 máx.



Las medidas pueden variar +/-1cm / Measurements may vary +/-1cm

PRODUCTO PRODUCT	COD.	DESCRIPCIÓN DESCRIPTION	KG			PR
PR	PR-880	Panel Balearia Marrón	PR: 31,5 kg	PR: --	PR: --	€/unidad -

Complementos necesarios para la instalación / Necessary materials for installation

Rendimiento Aprox. / Average Usage	Precio / Price
1 Cartucho 1 Panel	-
1 Pintura 3 Paneles	-
1 Pintura 3 Paneles	-

Complementos opcionales para la instalación / Optional materials for installation

Rendimiento Aprox. / Average Usage	Precio / Price
1 Cartucho 2 Paneles	-

PRODUCTO PRODUCT	COD.	DESCRIPCIÓN DESCRIPTION	KG			PR
PR	PR-881	Panel Balearia Marrón Viejo	PR: 31,5 kg	PR: --	PR: --	€/unidad -

Complementos necesarios para la instalación / Necessary materials for installation

Rendimiento Aprox. / Average Usage	Precio / Price
1 Cartucho 1 Panel	-
1 Pintura 3 Paneles	-
1 Pintura 3 Paneles	-

Complementos opcionales para la instalación / Optional materials for installation

Rendimiento Aprox. / Average Usage	Precio / Price
1 Cartucho 2 Paneles	-

PRODUCTO PRODUCT	COD.	DESCRIPCIÓN DESCRIPTION	KG			PR
PR	PR-882	Panel Balearia Marrón Pátina	PR: 31,5 kg	PR: --	PR: --	€/unidad -

Complementos necesarios para la instalación / Necessary materials for installation

Rendimiento Aprox. / Average Usage	Precio / Price
1 Cartucho 1 Panel	-
1 Pintura 3 Paneles	-
1 Pintura 3 Paneles	-

Complementos opcionales para la instalación / Optional materials for installation

Rendimiento Aprox. / Average Usage	Precio / Price
1 Cartucho 2 Paneles	-

Forest BALEARIA

ACABADOS / FINISHES



PR-880
Marrón /
Brown

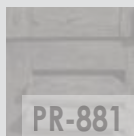

PR-881
Marrón Viejo /
Old Brown



PR-882
Marrón Pátina /
Patina Brown



PR-883
Gris Pátina /
Patina Grey



PR-884
Azul Pátina /
Patina Blue

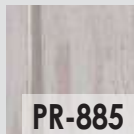

PR-885
Rosa Pátina /
Patina Pink

MEDIDAS / MEASUREMENTS

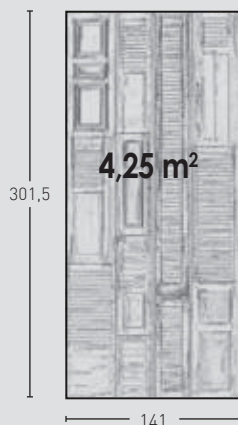

2,5 mín.
4,5 máx.



Las medidas pueden variar +/- 1cm / Measurements may vary +/- 1cm

PRODUCTO PRODUCT	COD.	DESCRIPCIÓN DESCRIPTION	KG			PR	€/unidad
PR	PR-883	Panel Balearia Gris Pátina	PR: 31,5 kg	PR: --	PR: --	-	

Complementos necesarios para la instalación / Necessary materials for installation			Rendimiento Aprox. / Average Usage		Precio / Price
	<input type="radio"/> MSA-70 Masilla Juntas Blanco Italia		1 Cartucho 1 Panel	-	
	<input type="radio"/> PTX-90 Pintura Cassee Blanco		1 Pintura 3 Paneles	-	
	<input checked="" type="radio"/> PTE-46 Pintura Envejecido Betún de Judea		1 Pintura 3 Paneles	-	

Complementos opcionales para la instalación / Optional materials for installation			Rendimiento Aprox. / Average Usage		Precio / Price
	<input type="radio"/> MSA-3 Masilla de Pegado		1 Cartucho 2 Paneles	-	

PRODUCTO PRODUCT	COD.	DESCRIPCIÓN DESCRIPTION	KG			PR	€/unidad
PR	PR-884	Panel Balearia Azul Pátina	PR: 31,5 kg	PR: --	PR: --	-	

Complementos necesarios para la instalación / Necessary materials for installation			Rendimiento Aprox. / Average Usage		Precio / Price
	<input type="radio"/> MSA-70 Masilla Juntas Blanco Italia		1 Cartucho 1 Panel	-	
	<input type="radio"/> PTX-90 Pintura Cassee Blanco		1 Pintura 3 Paneles	-	
	<input checked="" type="radio"/> PTE-46 Pintura Envejecido Betún de Judea		1 Pintura 3 Paneles	-	

Complementos opcionales para la instalación / Optional materials for installation			Rendimiento Aprox. / Average Usage		Precio / Price
	<input type="radio"/> MSA-3 Masilla de Pegado		1 Cartucho 2 Paneles	-	

PRODUCTO PRODUCT	COD.	DESCRIPCIÓN DESCRIPTION	KG			PR	€/unidad
PR	PR-885	Panel Balearia Rosa Pátina	PR: 31,5 kg	PR: --	PR: --	-	

Complementos necesarios para la instalación / Necessary materials for installation			Rendimiento Aprox. / Average Usage		Precio / Price
	<input type="radio"/> MSA-70 Masilla Juntas Blanco Italia		1 Cartucho 1 Panel	-	
	<input type="radio"/> PTX-90 Pintura Cassee Blanco		1 Pintura 3 Paneles	-	
	<input checked="" type="radio"/> PTE-46 Pintura Envejecido Betún de Judea		1 Pintura 3 Paneles	-	

Complementos opcionales para la instalación / Optional materials for installation			Rendimiento Aprox. / Average Usage		Precio / Price
	<input type="radio"/> MSA-3 Masilla de Pegado		1 Cartucho 2 Paneles	-	

Forest LUMBIER®

(2022 Patented Design©)

PANELPIEDRA®

PR



PR 870 Marrón



PR 872 Marrón Pátina

PR 870 Marrón





PR 870 Marrón



PR 871 Marrón Viejo



PR 872 Marrón Pátina



PR 873 Gris Pátina



PR 874 Azul Pátina



PR 875 Rosa Pátina

ACABADOS / FINISHES



PR-870
Marrón /
Brown



PR-871
Marrón Viejo /
Old Brown

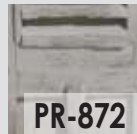

PR-872
Marrón Pátina /
Patina Brown



PR-873
Gris Pátina /
Patina Grey

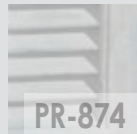

PR-874
Azul Pátina /
Patina Blue



PR-875
Rosa Pátina /
Patina Pink

MEDIDAS / MEASUREMENTS

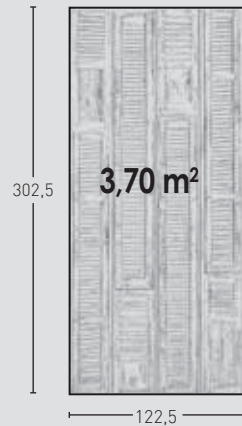

2,5 mín.
4,5 máx.

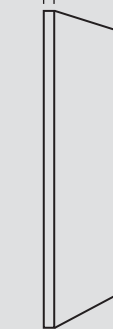

Las medidas pueden variar +/-1cm / Measurements may vary +/-1cm

PRODUCTO PRODUCT	COD.	DESCRIPCIÓN DESCRIPTION				PR	€/unidad
PR	PR-870	Panel Lumbier Marrón	PR: 28 kg (7 kg cada tira)	PR: --	PR: --	-	-

Complementos necesarios para la instalación / Necessary materials for installation **Rendimiento Aprox. / Average Usage** **Precio / Price**

	○ MSA-70 Masilla Juntas Blanco Italia	1 Cartucho 1 Panel	-
	● PTX-88 Pintura Difuminador Marrón	1 Pintura 3 Paneles	-
	● PTE-44 Pintura Glaseador Marrón	1 Pintura 3 Paneles	-

Complementos opcionales para la instalación / Optional materials for installation **Rendimiento Aprox. / Average Usage** **Precio / Price**

	○ MSA-3 Masilla de Pegado	1 Cartucho 2 Paneles	-
--	---------------------------	----------------------	---

PRODUCTO PRODUCT	COD.	DESCRIPCIÓN DESCRIPTION				PR	€/unidad
PR	PR-871	Panel Lumbier Marrón Viejo	PR: 28 kg (7 kg cada tira)	PR: --	PR: --	-	-

Complementos necesarios para la instalación / Necessary materials for installation **Rendimiento Aprox. / Average Usage** **Precio / Price**

	○ MSA-70 Masilla Juntas Blanco Italia	1 Cartucho 1 Panel	-
	● PTX-89 Pintura Difuminador Marrón Viejo	1 Pintura 3 Paneles	-
	● PTE-45 Pintura Glaseador Marrón Viejo	1 Pintura 3 Paneles	-

Complementos opcionales para la instalación / Optional materials for installation **Rendimiento Aprox. / Average Usage** **Precio / Price**

	○ MSA-3 Masilla de Pegado	1 Cartucho 2 Paneles	-
--	---------------------------	----------------------	---

PRODUCTO PRODUCT	COD.	DESCRIPCIÓN DESCRIPTION				PR	€/unidad
PR	PR-872	Panel Lumbier Marrón Pátina	PR: 28 kg (7 kg cada tira)	PR: --	PR: --	-	-

Complementos necesarios para la instalación / Necessary materials for installation **Rendimiento Aprox. / Average Usage** **Precio / Price**

	○ MSA-70 Masilla Juntas Blanco Italia	1 Cartucho 1 Panel	-
	○ PTX-90 Pintura Cassee Blanco	1 Pintura 3 Paneles	-
	● PTE-46 Pintura Envejecido Betún de Judea	1 Pintura 3 Paneles	-

Complementos opcionales para la instalación / Optional materials for installation **Rendimiento Aprox. / Average Usage** **Precio / Price**

	○ MSA-3 Masilla de Pegado	1 Cartucho 2 Paneles	-
--	---------------------------	----------------------	---

ACABADOS / FINISHES

MEDIDAS / MEASUREMENTS



PR-870

Marrón /
Brown



PR-871

Marrón Viejo /
Old Brown

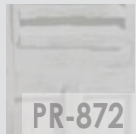

PR-872

Marrón Pátina /
Patina Brown



PR-873

Gris Pátina /
Patina Grey



PR-874

Azul Pátina /
Patina Blue



PR-875

Rosa Pátina /
Patina Pink

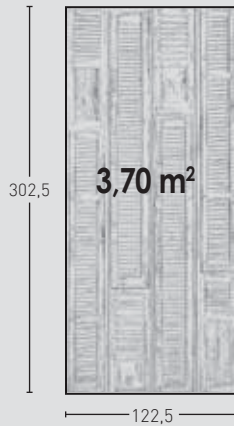

2,5 mín.
4,5 máx.



PRODUCTO PRODUCT	COD.	DESCRIPCIÓN DESCRIPTION	KG			PR
PR	PR-873	Panel Lumbier Gris Pátina	PR: 28 kg (7 kg cada tira)	PR: --	PR: --	€/unidad -

Complementos necesarios para la instalación / Necessary materials for installation			Rendimiento Aprox. / Average Usage		Precio / Price
	<input type="checkbox"/>	MSA-70 Masilla Juntas Blanco Italia	1	Cartucho 1 Panel	-
	<input type="checkbox"/>	PTX-90 Pintura Cassee Blanco	1	Pintura 3 Paneles	-
	<input checked="" type="checkbox"/>	PTE-46 Pintura Envejecido Betún de Judea	1	Pintura 3 Paneles	-

Complementos opcionales para la instalación / Optional materials for installation			Rendimiento Aprox. / Average Usage		Precio / Price
	<input type="checkbox"/>	MSA-3 Masilla de Pegado	1	Cartucho 2 Paneles	-

PRODUCTO PRODUCT	COD.	DESCRIPCIÓN DESCRIPTION	KG			PR
PR	PR-874	Panel Lumbier Azul Pátina	PR: 28 kg (7 kg cada tira)	PR: --	PR: --	€/unidad -

Complementos necesarios para la instalación / Necessary materials for installation			Rendimiento Aprox. / Average Usage		Precio / Price
	<input type="checkbox"/>	MSA-70 Masilla Juntas Blanco Italia	1	Cartucho 1 Panel	-
	<input type="checkbox"/>	PTX-90 Pintura Cassee Blanco	1	Pintura 3 Paneles	-
	<input checked="" type="checkbox"/>	PTE-46 Pintura Envejecido Betún de Judea	1	Pintura 3 Paneles	-

Complementos opcionales para la instalación / Optional materials for installation			Rendimiento Aprox. / Average Usage		Precio / Price
	<input type="checkbox"/>	MSA-3 Masilla de Pegado	1	Cartucho 2 Paneles	-

PRODUCTO PRODUCT	COD.	DESCRIPCIÓN DESCRIPTION	KG			PR
PR	PR-875	Panel Lumbier Rosa Pátina	PR: 28 kg (7 kg cada tira)	PR: --	PR: --	€/unidad -

Complementos necesarios para la instalación / Necessary materials for installation			Rendimiento Aprox. / Average Usage		Precio / Price
	<input type="checkbox"/>	MSA-70 Masilla Juntas Blanco Italia	1	Cartucho 1 Panel	-
	<input type="checkbox"/>	PTX-90 Pintura Cassee Blanco	1	Pintura 3 Paneles	-
	<input checked="" type="checkbox"/>	PTE-46 Pintura Envejecido Betún de Judea	1	Pintura 3 Paneles	-

Complementos opcionales para la instalación / Optional materials for installation			Rendimiento Aprox. / Average Usage		Precio / Price
	<input type="checkbox"/>	MSA-3 Masilla de Pegado	1	Cartucho 2 Paneles	-



CEMENT®

Collection



CEMENT®

Collection

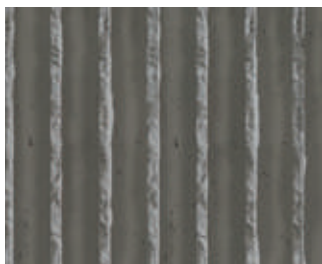

FACTORY / 48-51



GEOMÉTRICO / 52-55



HEXAGONAL / 56-59



VINTAGE / 60-63



TABLA / 64-67



TABLA XL / 68-71

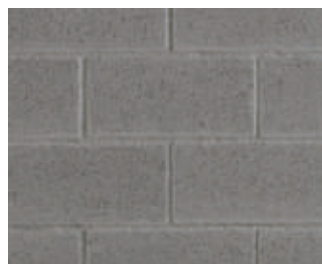

BLOQUE / 72-75



TOSCO / 76-79



CEMENTO / 80-85



HORMIGÓN / 86-89



ENCOFRADO / 90-93

Cement FACTORY®

(2018 Patented Design©)

PANELPIEDRA®

PR



PR 980 Gris



PR 980 Gris

PR 980 Gris

**El modelo Factory©, industrial, personal,
moderno atrevido y original.**

The Factory© model, industrial, personal,
modern, daring and original.

Cement
FACTORY

ACABADOS / FINISHES



980

Gris / Grey

MEDIDAS / MEASUREMENTS



1 mín.
6 máx.

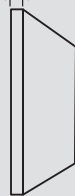

PRODUCTO PRODUCT	COD.	DESCRIPCIÓN DESCRIPTION	KG			PR	€/unidad
PR	980	Panel Factory	PR: 16-18kg	PR: --	PR: --	-	-
Complementos necesarios para la instalación / Necessary materials for installation				Rendimiento Aprox. / Average Usage		Precio / Price	
	<input type="radio"/>	MSA-10 Masilla Juntas Beige	1 Cartucho 1 Paneles		-		
	<input type="radio"/>	PTX-64 Pintura Cemento	1 Spray 3 Paneles		-		
Complementos opcionales para la instalación / Optional materials for installation				Rendimiento Aprox. / Average Usage		Precio / Price	
	<input type="radio"/>	MSA-3 Masilla de Pegado	1 Cartucho 2 Paneles		-		

Cement GEOMÉTRICO®

(2018 Patented Design©)

PANELPIEDRA®

PR

HD

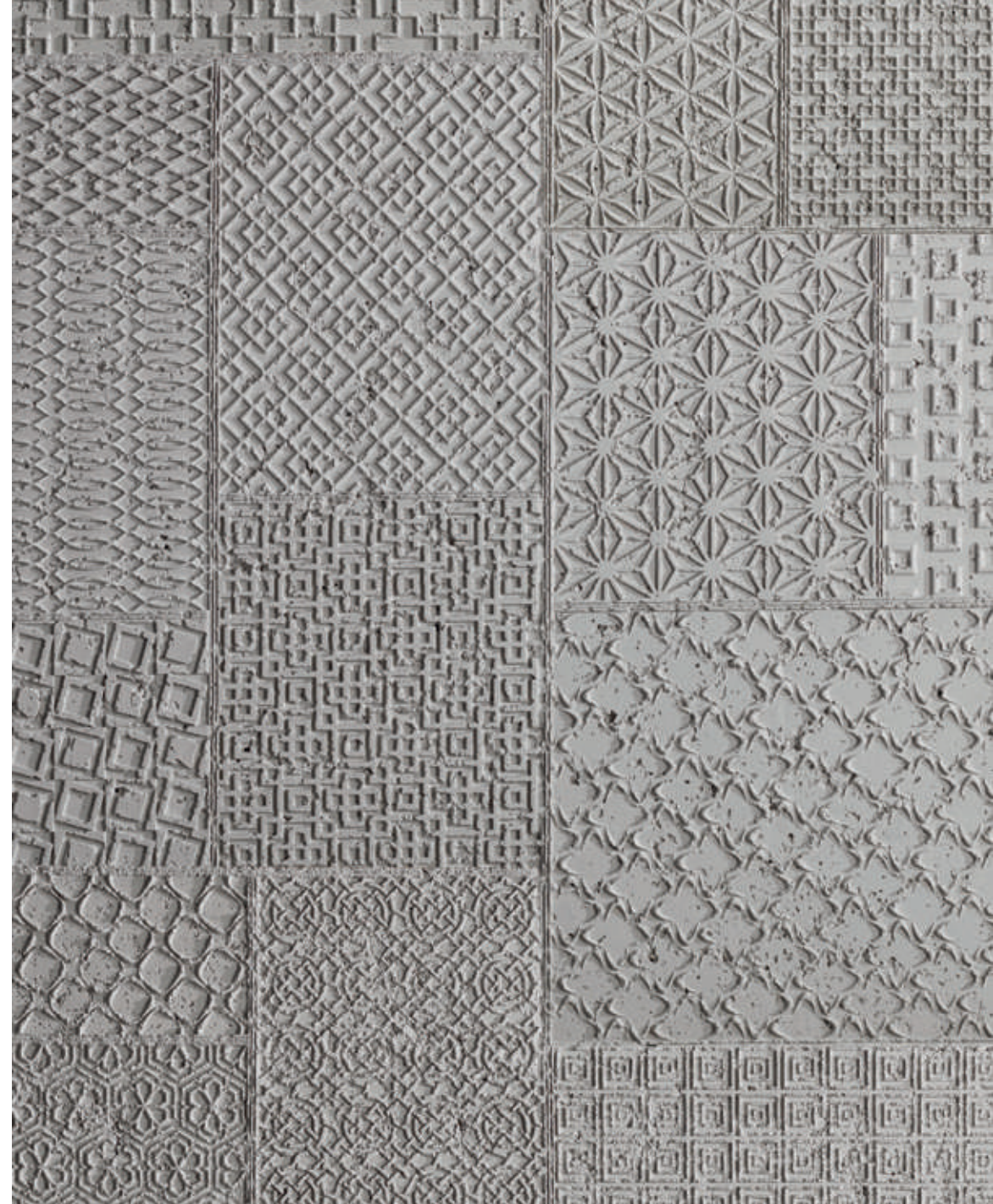

PR 950 Gris



PR 950 Gris



PR 950 Gris



PR 950 Gris

Cement GEOMÉTRICO

Cement GEOMÉTRICO

ACABADOS / FINISHES

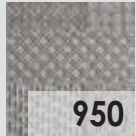

950

Gris / Grey

MEDIDAS / MEASUREMENTS

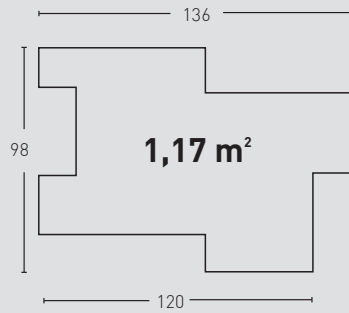
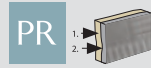

2 mín.
2 máx.



PRODUCTO PRODUCT	COD.	DESCRIPCIÓN DESCRIPTION	KG			PR	€/unidad
PR	950	Panel Geométrico Gris	PR: 6-7 kg	PR: 5 un	PR: 60 un	-	-
Complementos necesarios para la instalación / Necessary materials for installation				Rendimiento Aprox. / Average Usage		Precio / Price	
	<input type="radio"/>	MSA-10 Masilla Juntas Beige	1 Cartucho 2 - 3 Paneles		-		
	<input type="radio"/>	PTX-64 Pintura Cemento	1 Spray 8 - 10 Paneles		-		
Complementos opcionales para la instalación / Optional materials for installation				Rendimiento Aprox. / Average Usage		Precio / Price	
	<input type="radio"/>	MSA-3 Masilla de Pegado	1 Cartucho 4 - 5 Paneles		-		

Cement HEXAGONAL[®]

(2018 Patented Design©)

PANELPIEDRA[®]

PR

HD



PR 960 Gris



PR 960 Gris

PR 960 Gris

El modelo Hexagonal, de la Colección imitación Cemento. Diseño totalmente innovador. Espectacular acabado.

The Hexagonal model, from the Imitation Cement Collection. Totally innovative design with a spectacular finish.

Cement HEXAGONAL



Cement HEXAGONAL

ACABADOS / FINISHES



960

Gris / Grey

MEDIDAS / MEASUREMENTS

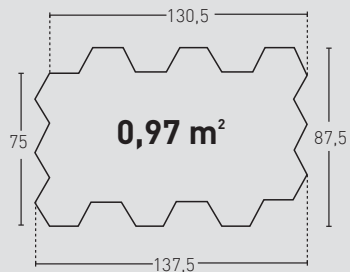

2 mín.
2 máx.



PRODUCTO PRODUCT	COD.	DESCRIPCIÓN DESCRIPTION	KG			PR	€/unidad
PR	960	Panel Hexagonal Gris	PR: 6-7 kg	PR: 5 un	PR: 60 un	-	-
Complementos necesarios para la instalación / Necessary materials for installation				Rendimiento Aprox. / Average Usage		Precio / Price	
	<input type="radio"/>	MSA-10 Masilla Juntas Beige	1 Cartucho 2 - 3 Paneles		-		-
	<input type="radio"/>	PTX-64 Pintura Cemento	1 Spray 8 - 10 Paneles		-		-
Complementos opcionales para la instalación / Optional materials for installation				Rendimiento Aprox. / Average Usage		Precio / Price	
	<input type="radio"/>	MSA-3 Masilla de Pegado	1 Cartucho 4 - 5 Paneles		-		-

Cement VINTAGE®

(2018 Patented Design©)

PANELPIEDRA®

PR

HD



PR 940 Gris



PR 940 Gris

PR 940 Gris



Cement VINTAGE

ACABADOS / FINISHES

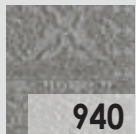

940

Gris / Grey

MEDIDAS / MEASUREMENTS

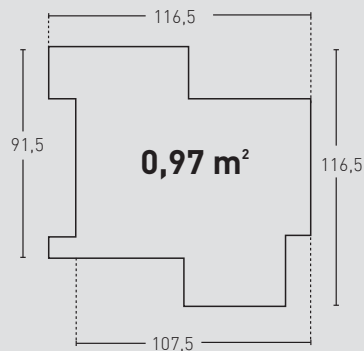

PRODUCTO PRODUCT	COD.	DESCRIPCIÓN DESCRIPTION	PR: 6-7 kg	PR: 5 un	PR: 60 un	PR	€/unidad
PR	940	Panel Vintage Gris				-	
Complementos necesarios para la instalación / Necessary materials for installation				Rendimiento Aprox. / Average Usage		Precio / Price	
	<input type="checkbox"/>	MSA-10 Masilla Juntas Beige	1 Cartucho 2 - 3 Paneles		-		
	<input type="checkbox"/>	PTX-64 Pintura Cemento	1 Spray 8 - 10 Paneles		-		
Complementos opcionales para la instalación / Optional materials for installation				Rendimiento Aprox. / Average Usage		Precio / Price	
	<input type="checkbox"/>	MSA-3 Masilla de Pegado	1 Cartucho 4 - 5 Paneles		-		

Las medidas pueden variar +/-1cm / Measurements may vary +/-1cm

Cement TABLA[®]

(2018 Patented Design©)

PANELPIEDRA[®]

PR

HD



PR 930 Gris



PR 930 Gris



Cement TABLA

ACABADOS / FINISHES

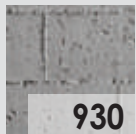

930

Gris / Grey

MEDIDAS / MEASUREMENTS

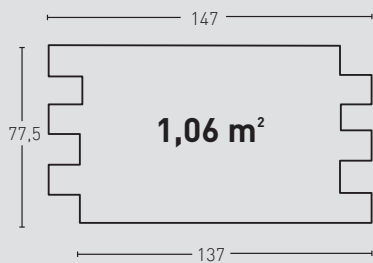

2 mín.
2 máx.

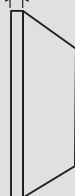

PRODUCTO PRODUCT	COD.	DESCRIPCIÓN DESCRIPTION				PR	HD
						€/unidad	
PR HD	930	Panel Tabla Gris	PR:6-7kg / HD:15-20kg	PR:6un / HD:25un	PR:60un / HD:25un	-	-
Complementos necesarios para la instalación / Necessary materials for installation				Rendimiento Aprox. / Average Usage		Precio / Price	
		● MSA-10 Masilla Juntas Beige	1 Cartucho 2 - 3 Paneles		-		
		● PTX-64 Pintura Cemento	1 Spray 8 - 10 Paneles		-		
Complementos opcionales para la instalación / Optional materials for installation				Rendimiento Aprox. / Average Usage		Precio / Price	
		○ MSA-3 Masilla de Pegado	1 Cartucho 4 - 5 Paneles		-		

Cement TABLA XL[®]

(2018 Patented Design©)

PANELPIEDRA[®]

PR



PR 9300 Gris



PR 9300 Gris

PR 9300 Gris



Cement
TABLA XL

Cement TABLA XL

ACABADOS / FINISHES

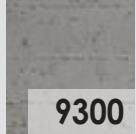

9300

Gris / Grey

MEDIDAS / MEASUREMENTS

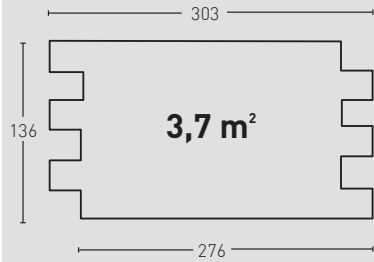

2 mín.

2 máx.



PRODUCTO PRODUCT	COD.	DESCRIPCIÓN DESCRIPTION				PR	€/unidad
PR	9300	Panel Tabla XL Gris	PR: 16-18 kg	PR: --	PR: --	-	-
Complementos necesarios para la instalación / Necessary materials for installation				Rendimiento Aprox. / Average Usage		Precio / Price	
		● MSA-10 Masilla Juntas Beige	1 Cartucho 1 Paneles		-		
		● PTX-64 Pintura Cemento	1 Spray 3 Paneles		-		
Complementos opcionales para la instalación / Optional materials for installation				Rendimiento Aprox. / Average Usage		Precio / Price	
		○ MSA-3 Masilla de Pegado	1 Cartucho 2 Paneles		-		

Las medidas pueden variar +/-1cm / Measurements may vary +/-1cm

* Consultar fecha de entrega / Consult delivery date - * Recargo por transporte / Transport surcharge

Cement BLOQUE®

(2018 Patented Design©)

PANELPIEDRA®

PR



PR 970 Gris



PR 970 Gris

PR 970 Gris

TAN
GO
FURNITURE

Cement BLOQUE

ACABADOS / FINISHES

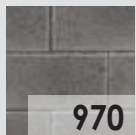

970

Gris / Grey

MEDIDAS / MEASUREMENTS

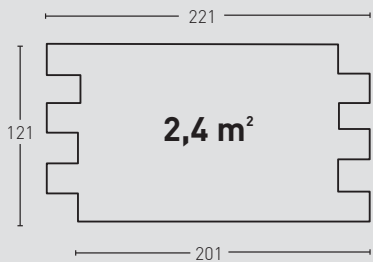

2 mín.
2 máx.



PRODUCTO PRODUCT	COD.	DESCRIPCIÓN DESCRIPTION				PR	€/unidad
PR	970	Panel Bloque Gris	PR: 14-16 kg	PR: --	PR: --	-	-
Complementos necesarios para la instalación / Necessary materials for installation				Rendimiento Aprox. / Average Usage		Precio / Price	
		● MSA-10 Masilla Juntas Beige ● PTX-64 Pintura Cemento	1 Cartucho 2 Paneles 1 Spray 3 Paneles		- -		-
Complementos opcionales para la instalación / Optional materials for installation				Rendimiento Aprox. / Average Usage		Precio / Price	
		○ MSA-3 Masilla de Pegado	1 Cartucho 2 Paneles		-		-

Cement TOSCO®

(2018 Patented Design©)

PANELPIEDRA®

PR

HD



PR 910 Gris



PR 910 Gris



PR 910 Gris



PR 910 Gris

Cement
TOSCO

Cement TOSCO

ACABADOS / FINISHES



910

Gris / Grey

MEDIDAS / MEASUREMENTS

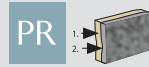

150

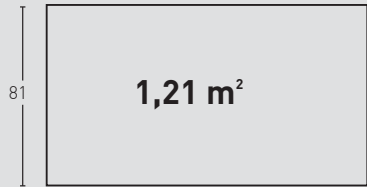

2 mín.
2 máx.



PRODUCTO PRODUCT	COD.	DESCRIPCIÓN DESCRIPTION	KG			PR	€/unidad
PR	910	Panel Tosco Gris	PR: 6-7 kg	PR: 5 un	PR: 60 un	-	-
Complementos necesarios para la instalación / Necessary materials for installation				Rendimiento Aprox. / Average Usage		Precio / Price	
		● MSA-10 Masilla Juntas Beige	1 Cartucho 2 - 3 Paneles		-		
		● PTX-64 Pintura Cemento	1 Spray 8 - 10 Paneles		-		
Complementos opcionales para la instalación / Optional materials for installation				Rendimiento Aprox. / Average Usage		Precio / Price	
		○ MSA-3 Masilla de Pegado	1 Cartucho 4 - 5 Paneles		-		

Cement CEMENTO®

(2018 Patented Design©)

PANELPIEDRA®

PR

HD



PR 320 Gris



PR 321 Óxido



PR 320 Gris



PR 321 Óxido



PR 322 Antracita

Cement CEMENTO

Modelo Cemento con unos acabados tan reales como sorprendentes.

Cement model with finishes as real as they are surprising.



PR 321 Óxido

Cement CEMENTO

ACABADOS / FINISHES

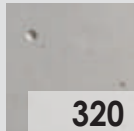

320
Gris / Grey

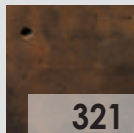

321
Óxido / Rusty

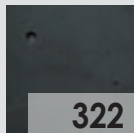

322
Antracita / Anthracite

MEDIDAS / MEASUREMENTS

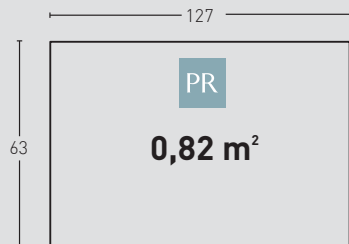

2 mín.
2 máx.



PRODUCTO PRODUCT	COD.	DESCRIPCIÓN DESCRIPTION	KG			PR	HD
PR HD	320	Panel Cemento Gris	PR:5-6kg / HD:15-20kg	PR:6un / HD:25un	PR:72un / HD:25un	-	-

Complementos necesarios para la instalación / Necessary materials for installation

Complementos necesarios para la instalación / Necessary materials for installation	Rendimiento Aprox. / Average Usage	Precio / Price
● MSA-10 Masilla Juntas Beige	1 Cartucho 2 - 3 Paneles	-
● PTX-64 Pintura Cemento	1 Spray 8 - 10 Paneles	-

Complementos opcionales para la instalación / Optional materials for installation

Complementos opcionales para la instalación / Optional materials for installation	Rendimiento Aprox. / Average Usage	Precio / Price
○ MSA-3 Masilla de Pegado	1 Cartucho 7 Paneles	-

PRODUCTO PRODUCT	COD.	DESCRIPCIÓN DESCRIPTION	KG			PR	HD
PR HD	321	Panel Cemento Óxido	PR:5-6kg / HD:15-20kg	PR:6un / HD:25un	PR:72un / HD:25un	-	-

Complementos necesarios para la instalación / Necessary materials for installation

Complementos necesarios para la instalación / Necessary materials for installation	Rendimiento Aprox. / Average Usage	Precio / Price
● MSA-60 Masilla Juntas Antracita	1 Cartucho 4 Paneles	-
● PTX-24 Pintura Óxido Metal	1 Pintura 10 Paneles	-
● PTE-28 Envejecido Óxido + Comp6 (Bote)	1 Bote 10 Paneles	-
○ BR-01 Spray Protector de Óxido	1 Spray 10 Paneles	-

Complementos opcionales para la instalación / Optional materials for installation

Complementos opcionales para la instalación / Optional materials for installation	Rendimiento Aprox. / Average Usage	Precio / Price
○ MSA-3 Masilla de Pegado	1 Cartucho 7 Paneles	-

PRODUCTO PRODUCT	COD.	DESCRIPCIÓN DESCRIPTION	KG			PR	HD
PR HD	322	Panel Cemento Antracita	PR:5-6kg / HD:15-20kg	PR:6un / HD:25un	PR:72un / HD:25un	-	-

Complementos necesarios para la instalación / Necessary materials for installation

Complementos necesarios para la instalación / Necessary materials for installation	Rendimiento Aprox. / Average Usage	Precio / Price
● MSA-60 Masilla Juntas Antracita	1 Cartucho 4 Paneles	-
● PTX-19 Pintura Antracita	1 Spray 6 Paneles	-

Complementos opcionales para la instalación / Optional materials for installation

Complementos opcionales para la instalación / Optional materials for installation	Rendimiento Aprox. / Average Usage	Precio / Price
○ MSA-3 Masilla de Pegado	1 Cartucho 7 Paneles	-

Cement HORMIGÓN®

(2018 Patented Design©)

PANELPIEDRA®

PR

HD



PR 325 Antracita



PR 326 Gris

Cement
HORMIGÓN



PR 325 Antracita

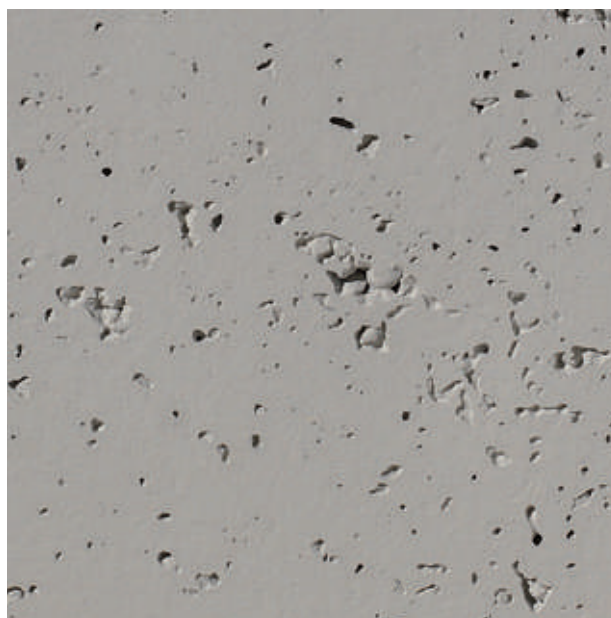

PR 326 Gris



PR 327 Óxido

Cement HORMIGÓN

ACABADOS / FINISHES

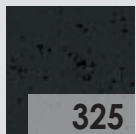

325
Antracita / Anthracite

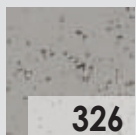

326
Gris / Grey

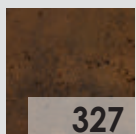

327
Óxido / Rusty

MEDIDAS / MEASUREMENTS

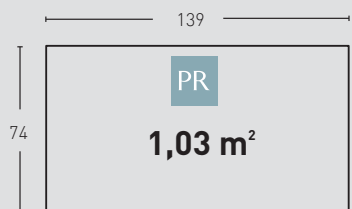

2 mín.
2 máx.

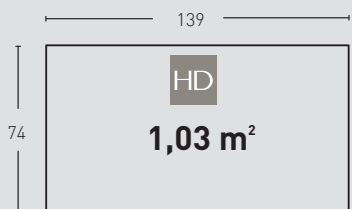

1 mín.
1 máx.



Las medidas pueden variar +/- 1cm / Measurements may vary +/- 1cm

PRODUCTO PRODUCT	COD.	DESCRIPCIÓN DESCRIPTION	KG			PR	HD
PR HD	325	Panel Hormigón Antracita	PR:5-6kg / HD:15-20kg	PR:6un / HD:25un	PR:72un / HD:25un	-	-

Complementos necesarios para la instalación / Necessary materials for installation

Complementos necesarios para la instalación / Necessary materials for installation	Rendimiento Aprox. / Average Usage	Precio / Price
● MSA-60 Masilla Juntas Antracita	1 Cartucho 4 Paneles	-
● PTX-19 Pintura Antracita	1 Spray 6 Paneles	-

Complementos opcionales para la instalación / Optional materials for installation

Complementos opcionales para la instalación / Optional materials for installation	Rendimiento Aprox. / Average Usage	Precio / Price
○ MSA-3 Masilla de Pegado	1 Cartucho 7 Paneles	-

PRODUCTO PRODUCT	COD.	DESCRIPCIÓN DESCRIPTION	KG			PR	HD
PR HD	326	Panel Hormigón Gris	PR:5-6kg / HD:15-20kg	PR:6un / HD:25un	PR:72un / HD:25un	-	-

Complementos necesarios para la instalación / Necessary materials for installation

Complementos necesarios para la instalación / Necessary materials for installation	Rendimiento Aprox. / Average Usage	Precio / Price
● MSA-10 Masilla Juntas Beige	1 Cartucho 2 - 3 Paneles	-
● PTX-64 Pintura Cemento	1 Spray 8 - 10 Paneles	-

Complementos opcionales para la instalación / Optional materials for installation

Complementos opcionales para la instalación / Optional materials for installation	Rendimiento Aprox. / Average Usage	Precio / Price
○ MSA-3 Masilla de Pegado	1 Cartucho 7 Paneles	-

PRODUCTO PRODUCT	COD.	DESCRIPCIÓN DESCRIPTION	KG			PR	HD
PR HD	327	Panel Hormigón Óxido	PR:5-6kg / HD:15-20kg	PR:6un / HD:25un	PR:72un / HD:25un	-	-

Complementos necesarios para la instalación / Necessary materials for installation

Complementos necesarios para la instalación / Necessary materials for installation	Rendimiento Aprox. / Average Usage	Precio / Price
● MSA-60 Masilla Juntas Antracita	1 Cartucho 4 Paneles	-
● PTX-24 Pintura Óxido Metal	1 Pintura 10 Paneles	-
● PTE-28 Envejecido Óxido + Compó (Bote)	1 Bote 10 Paneles	-
○ BR-01 Spray Protector de Óxido	1 Spray 10 Paneles	-

Complementos opcionales para la instalación / Optional materials for installation

Complementos opcionales para la instalación / Optional materials for installation	Rendimiento Aprox. / Average Usage	Precio / Price
○ MSA-3 Masilla de Pegado	1 Cartucho 7 Paneles	-

Cement ENCOFRADO®

(2018 Patented Design©)

PANELPIEDRA®

PR

HD



PR 920 Gris



PR 920 Gris

PR 920 Gris



Cement ENCOFRADO

ACABADOS / FINISHES

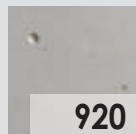

920
Gris / Grey

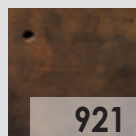

921
Óxido / Rusty

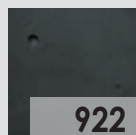

922
Antracita / Anthracite

MEDIDAS / MEASUREMENTS

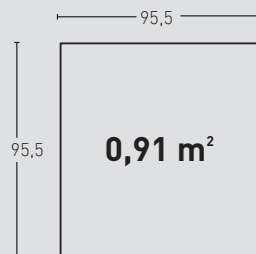

2 mín.
3 máx.



Las medidas pueden variar +/- 1cm / Measurements may vary +/- 1cm

PRODUCTO PRODUCT	COD.	DESCRIPCIÓN DESCRIPTION				PR	€/unidad
PR	920	Panel Encofrado Gris	PR: 6-7 kg	PR: 5 un	PR: 60 un	-	-

Complementos necesarios para la instalación / Necessary materials for installation

Complementos necesarios para la instalación / Necessary materials for installation	Rendimiento Aprox. / Average Usage	Precio / Price
● MSA-10 Masilla Juntas Beige	1 Cartucho 4 Paneles	-
● PTX-64 Pintura Cemento	1 Spray 10 Paneles	-

Complementos opcionales para la instalación / Optional materials for installation

Complementos opcionales para la instalación / Optional materials for installation	Rendimiento Aprox. / Average Usage	Precio / Price
○ MSA-3 Masilla de Pegado	1 Cartucho 7 Paneles	-

PRODUCTO PRODUCT	COD.	DESCRIPCIÓN DESCRIPTION				PR	€/unidad
PR	921	Panel Encofrado Óxido	PR: 6-7 kg	PR: 5 un	PR: 60 un	-	-

Complementos necesarios para la instalación / Necessary materials for installation

Complementos necesarios para la instalación / Necessary materials for installation	Rendimiento Aprox. / Average Usage	Precio / Price
● MSA-60 Masilla Juntas Antracita	1 Cartucho 4 Paneles	-
● PTX-24 Pintura Óxido Metal	1 Pintura 10 Paneles	-
● PTE-28 Envejecido Óxido + Compó (Bote)	1 Bote 10 Paneles	-
○ BR-01 Spray Protector de Óxido	1 Spray 10 Paneles	-

Complementos opcionales para la instalación / Optional materials for installation

Complementos opcionales para la instalación / Optional materials for installation	Rendimiento Aprox. / Average Usage	Precio / Price
○ MSA-3 Masilla de Pegado	1 Cartucho 7 Paneles	-

PRODUCTO PRODUCT	COD.	DESCRIPCIÓN DESCRIPTION				PR	€/unidad
PR	922	Panel Encofrado Antracita	PR: 6-7 kg	PR: 5 un	PR: 60 un	-	-

Complementos necesarios para la instalación / Necessary materials for installation

Complementos necesarios para la instalación / Necessary materials for installation	Rendimiento Aprox. / Average Usage	Precio / Price
● MSA-60 Masilla Juntas Antracita	1 Cartucho 4 Paneles	-
● PTX-19 Pintura Antracita	1 Spray 6 Paneles	-

Complementos opcionales para la instalación / Optional materials for installation

Complementos opcionales para la instalación / Optional materials for installation	Rendimiento Aprox. / Average Usage	Precio / Price
○ MSA-3 Masilla de Pegado	1 Cartucho 7 Paneles	-

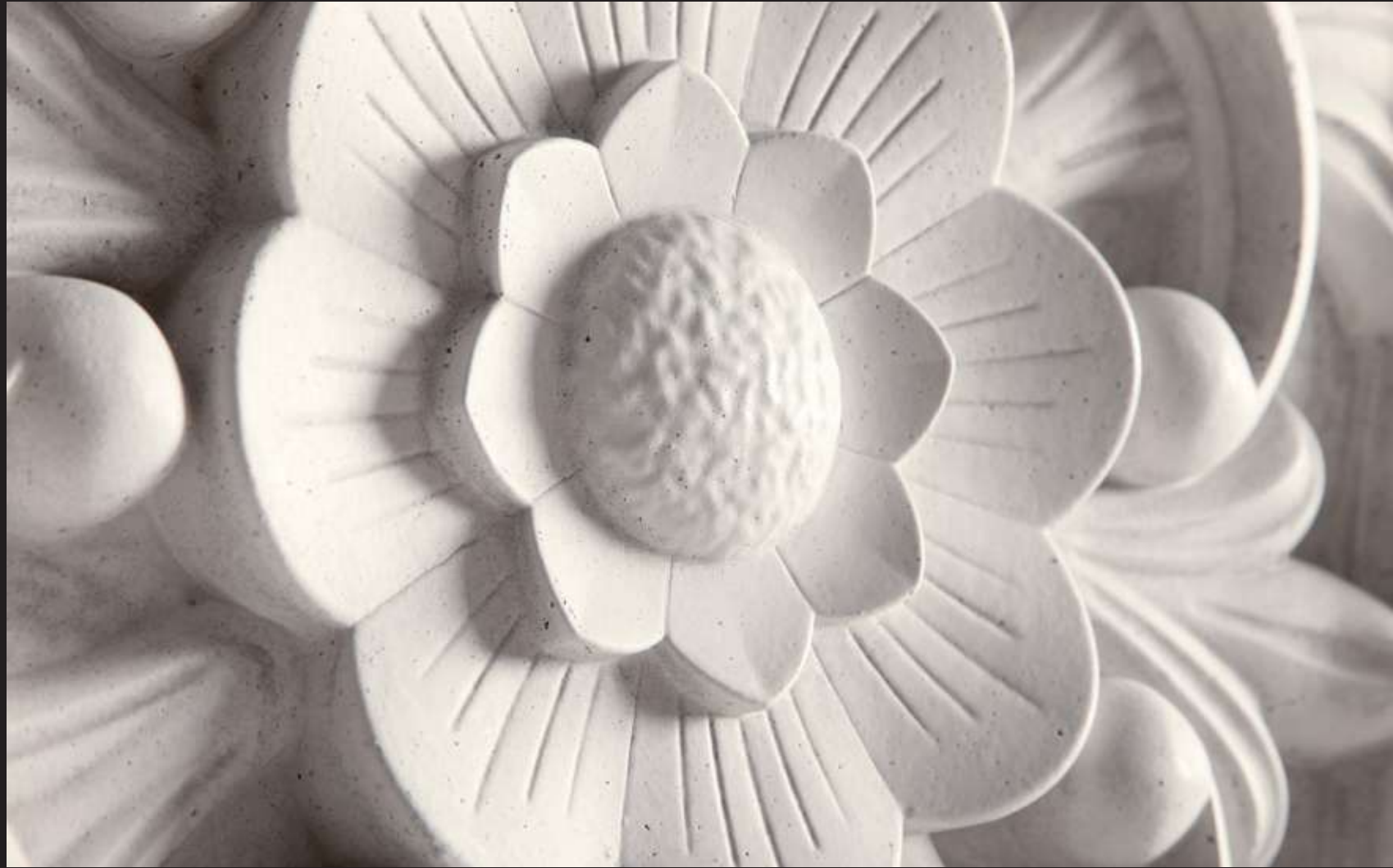

VINTAGE®

Collection



VINTAGE®

Collection



WINDSOR / 98-101



VERSALLES / 102-105



ASHFORD / 106-109



ALHAMBRA / 110-113



BLAIR / 114-117



BELVER / 118-121



LOIRA / 122-125



CHANTILLY / 126-129

Vintage WINDSOR®

(2016 Patented Design©)

PANELPIEDRA®

PR



PR 1074 Decapé Gris



PR 1070 Blanco Italia

Vintage WINDSOR

ACABADOS / FINISHES



1070
Blanco Italia /
Italian White



1071
Blanco Envejecido /
Aged White



1072
Decapé Ocre /
Ochre Decape



1073
Decapé Marrón /
Brown Decape



1074
Decapé Gris /
Grey Decape

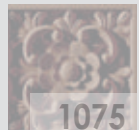

1075
Óxido / Rusty

MEDIDAS / MEASUREMENTS

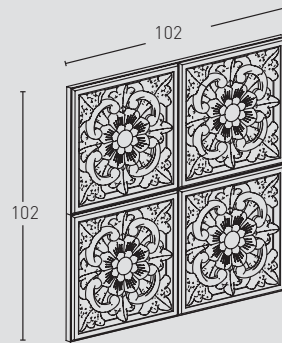

3 mín.
4,5 máx.



1 m²

Las medidas pueden variar +/-1cm / Measurements may vary +/-1cm

PRODUCTO PRODUCT	COD.	DESCRIPCIÓN DESCRIPTION	KG			PR
PR	1070	Panel Windsor Blanco Italia	PR: 7-8 kg	PR: 3 un	PR: 48 un	-

Complementos necesarios para la instalación / Necessary materials for installation

Rendimiento Aprox. / Average Usage	Precio / Price
1 Cartucho 2 - 3 Paneles	-
1 Spray 8 Paneles	-

Complementos opcionales para la instalación / Optional materials for installation

Rendimiento Aprox. / Average Usage	Precio / Price
1 Cartucho 4 - 5 Paneles	-

PRODUCTO PRODUCT	COD.	DESCRIPCIÓN DESCRIPTION	KG			PR
PR	1071	Panel Windsor Blanco Envejecido	PR: 7-8 kg	PR: 3 un	PR: 48 un	-

Complementos necesarios para la instalación / Necessary materials for installation

Rendimiento Aprox. / Average Usage	Precio / Price
1 Cartucho 2 - 3 Paneles	-
1 Spray 8 Paneles	-
1 Spray 15 Paneles	-

Complementos opcionales para la instalación / Optional materials for installation

Rendimiento Aprox. / Average Usage	Precio / Price
1 Cartucho 4 - 5 Paneles	-

PRODUCTO PRODUCT	COD.	DESCRIPCIÓN DESCRIPTION	KG			PR
PR	1072	Panel Windsor Decape Ocre	PR: 7-8 kg	PR: 3 un	PR: 48 un	-

Complementos necesarios para la instalación / Necessary materials for installation

Rendimiento Aprox. / Average Usage	Precio / Price
1 Cartucho 2 - 3 Paneles	-
1 Spray 8 Paneles	-
1 Spray 15 Paneles	-

Complementos opcionales para la instalación / Optional materials for installation

Rendimiento Aprox. / Average Usage	Precio / Price
1 Cartucho 4 - 5 Paneles	-

Vintage WINDSOR

ACABADOS / FINISHES



1070
Blanco Italia /
Italian White



1071
Blanco Envejecido /
Aged White



1072
Decapé Ocre /
Ochre Decape



1073
Decapé Marrón /
Brown Decape



1074
Decapé Gris /
Grey Decape



1075
Óxido / Rusty

MEDIDAS / MEASUREMENTS

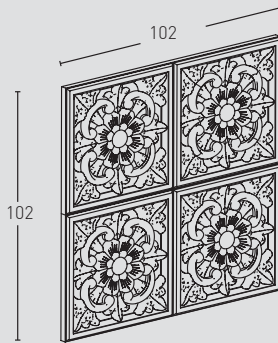

3 mín.
4,5 máx.



1 m²

Las medidas pueden variar +/- 1cm / Measurements may vary +/- 1cm

PRODUCTO PRODUCT	COD.	DESCRIPCIÓN DESCRIPTION	KG			PR
PR	1073	Panel Windsor Decape Marrón	PR: 7-8 kg	PR: 3 un	PR: 48 un	-

Complementos necesarios para la instalación / Necessary materials for installation

Rendimiento Aprox. / Average Usage	Precio / Price
1 Cartucho 2 - 3 Paneles	-
1 Spray 8 Paneles	-
1 Spray 15 Paneles	-

Complementos opcionales para la instalación / Optional materials for installation

Rendimiento Aprox. / Average Usage	Precio / Price
1 Cartucho 4 - 5 Paneles	-

PRODUCTO PRODUCT	COD.	DESCRIPCIÓN DESCRIPTION	KG			PR
PR	1074	Panel Windsor Decape Gris	PR: 7-8 kg	PR: 3 un	PR: 48 un	-

Complementos necesarios para la instalación / Necessary materials for installation

Rendimiento Aprox. / Average Usage	Precio / Price
1 Cartucho 2 - 3 Paneles	-
1 Spray 8 Paneles	-
1 Spray 15 Paneles	-

Complementos opcionales para la instalación / Optional materials for installation

Rendimiento Aprox. / Average Usage	Precio / Price
1 Cartucho 4 - 5 Paneles	-

PRODUCTO PRODUCT	COD.	DESCRIPCIÓN DESCRIPTION	KG			PR
PR	1075	Panel Windsor Óxido	PR: 7-8 kg	PR: 3 un	PR: 48 un	-

Complementos necesarios para la instalación / Necessary materials for installation

Rendimiento Aprox. / Average Usage	Precio / Price
1 Cartucho 2 - 3 Paneles	-
1 Spray 8 Paneles	-
1 Spray 8 Paneles	-
1 Spray 15 Paneles	-

Complementos opcionales para la instalación / Optional materials for installation

Rendimiento Aprox. / Average Usage	Precio / Price
1 Cartucho 4 - 5 Paneles	-

Vintage VERSALLES®

(2016 Patented Design©)

PANELPIEDRA®

PR



PR 1063 Decape Marrón



PR 1063 Decape Marrón

Vintage VERSALLES

ACABADOS / FINISHES



1060
Blanco Italia /
Italian White

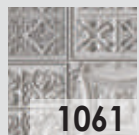

1061
Blanco Envejecido /
Aged White

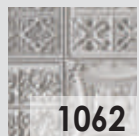

1062
Decapé Ocre /
Ochre Decape



1063
Decapé Marrón /
Brown Decape

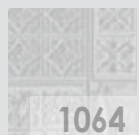

1064
Decapé Gris /
Grey Decape

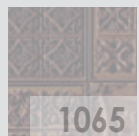

1065
Óxido / Rusty

MEDIDAS / MEASUREMENTS

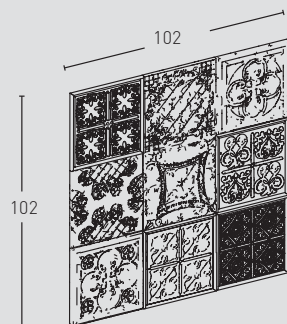

2 mín.
3 máx.



1 m²

Las medidas pueden variar +/-1cm / Measurements may vary +/-1cm

PRODUCTO PRODUCT	COD.	DESCRIPCIÓN DESCRIPTION	KG			PR
PR	1060	Panel Versalles Blanco Italia	PR: 7-8 kg	PR: 5 un	PR: 48 un	-

Complementos necesarios para la instalación / Necessary materials for installation

Rendimiento Aprox. / Average Usage	Precio / Price
1 Cartucho 2 - 3 Paneles	-
1 Spray 8 Paneles	-

Complementos opcionales para la instalación / Optional materials for installation

Rendimiento Aprox. / Average Usage	Precio / Price
1 Cartucho 4 - 5 Paneles	-

PRODUCTO PRODUCT	COD.	DESCRIPCIÓN DESCRIPTION	KG			PR
PR	1061	Panel Versalles Blanco Envejecido	PR: 7-8 kg	PR: 5 un	PR: 48 un	-

Complementos necesarios para la instalación / Necessary materials for installation

Rendimiento Aprox. / Average Usage	Precio / Price
1 Cartucho 2 - 3 Paneles	-
1 Spray 8 Paneles	-
1 Spray 15 Paneles	-

Complementos opcionales para la instalación / Optional materials for installation

Rendimiento Aprox. / Average Usage	Precio / Price
1 Cartucho 4 - 5 Paneles	-

PRODUCTO PRODUCT	COD.	DESCRIPCIÓN DESCRIPTION	KG			PR
PR	1062	Panel Versalles Decape Ocre	PR: 7-8 kg	PR: 3 un	PR: 48 un	-

Complementos necesarios para la instalación / Necessary materials for installation

Rendimiento Aprox. / Average Usage	Precio / Price
1 Cartucho 2 - 3 Paneles	-
1 Spray 8 Paneles	-
1 Spray 15 Paneles	-

Complementos opcionales para la instalación / Optional materials for installation

Rendimiento Aprox. / Average Usage	Precio / Price
1 Cartucho 4 - 5 Paneles	-

Vintage VERSALLES

ACABADOS / FINISHES



1060

Blanco Italia / Italian White



1061

Blanco Envejecido / Aged White



1062

Decapé Ocre / Ochre Decape

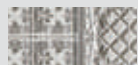

1063

Decapé Marrón / Brown Decape



1064

Decapé Gris / Grey Decape



1065

Óxido / Rusty

MEDIDAS / MEASUREMENTS

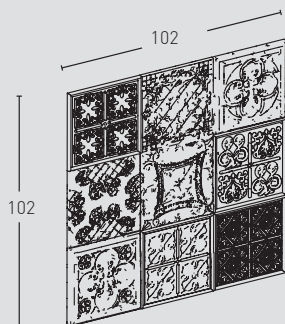

2 mín.
3 máx.

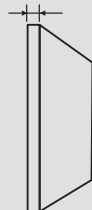

1 m²

Las medidas pueden variar +/- 1cm / Measurements may vary +/- 1cm

PRODUCTO PRODUCT	COD.	DESCRIPCIÓN DESCRIPTION	KG			PR	€/unidad
PR	1063	Panel Versalles Decape Marrón	PR: 7-8 kg	PR: 5 un	PR: 48 un	-	-
Complementos necesarios para la instalación / Necessary materials for installation				Rendimiento Aprox. / Average Usage		Precio / Price	
	<input type="checkbox"/>	MSA-70 Masilla Juntas Blanco Italia		1 Cartucho 2 - 3 Paneles		-	
	<input type="checkbox"/>	PTX-71 Blanco Italia Decape		1 Spray 8 Paneles		-	
	<input type="checkbox"/>	PTX-73 Pintura Decape Marrón		1 Spray 15 Paneles		-	
Complementos opcionales para la instalación / Optional materials for installation				Rendimiento Aprox. / Average Usage		Precio / Price	
	<input type="checkbox"/>	MSA-3 Masilla de Pegado		1 Cartucho 4 - 5 Paneles		-	
PRODUCTO PRODUCT	COD.	DESCRIPCIÓN DESCRIPTION	KG			PR	€/unidad
PR	1064	Panel Versalles Decape Gris	PR: 7-8 kg	PR: 5 un	PR: 48 un	-	-
Complementos necesarios para la instalación / Necessary materials for installation				Rendimiento Aprox. / Average Usage		Precio / Price	
	<input type="checkbox"/>	MSA-70 Masilla Juntas Blanco Italia		1 Cartucho 2 - 3 Paneles		-	
	<input type="checkbox"/>	PTX-71 Blanco Italia Decape		1 Spray 8 Paneles		-	
	<input type="checkbox"/>	PTX-74 Pintura Decape Gris		1 Spray 15 Paneles		-	
Complementos opcionales para la instalación / Optional materials for installation				Rendimiento Aprox. / Average Usage		Precio / Price	
	<input type="checkbox"/>	MSA-3 Masilla de Pegado		1 Cartucho 4 - 5 Paneles		-	
PRODUCTO PRODUCT	COD.	DESCRIPCIÓN DESCRIPTION	KG			PR	€/unidad
PR	1065	Panel Versalles Óxido	PR: 7-8 kg	PR: 5 un	PR: 48 un	-	-
Complementos necesarios para la instalación / Necessary materials for installation				Rendimiento Aprox. / Average Usage		Precio / Price	
	<input type="checkbox"/>	MSA-60 Masilla Juntas Antracita		1 Cartucho 2 - 3 Paneles		-	
	<input type="checkbox"/>	PTX-24 Pintura Óxido Metal		1 Spray 8 Paneles		-	
	<input type="checkbox"/>	PTE-28 Envejecido Óxido + Compó (Bote)		1 Spray 8 Paneles		-	
	<input type="checkbox"/>	BR-01 Spray Protector de Óxido		1 Spray 20 Paneles		-	
Complementos opcionales para la instalación / Optional materials for installation				Rendimiento Aprox. / Average Usage		Precio / Price	
	<input type="checkbox"/>	MSA-3 Masilla de Pegado		1 Cartucho 4 - 5 Paneles		-	

VINTAGE

Vintage ASHFORD®

(2016 Patented Design©)

PANELPIEDRA®

PR



PR 1063 Decape Marrón



PR 1010 Blanco Italia

Vintage ASHFORD

ACABADOS / FINISHES



1010
Blanco Italia /
Italian White



1011
Blanco Envejecido /
Aged White



1012
Decapé Ocre /
Ochre Decape



1013
Decapé Marrón /
Brown Decape



1014
Decapé Gris /
Grey Decape

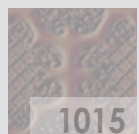

1015
Óxido / Rusty

MEDIDAS / MEASUREMENTS

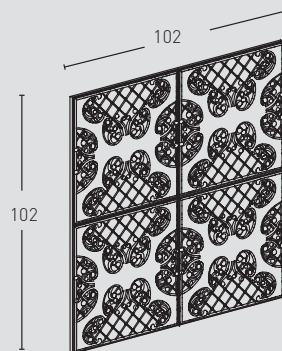

2 mín.
3,5 máx.



1 m²

Las medidas pueden variar +/-1cm / Measurements may vary +/-1cm

PRODUCTO PRODUCT	COD.	DESCRIPCIÓN DESCRIPTION	KG			PR
PR	1010	Panel Ashford Blanco Italia	PR: 7-8 kg	PR: 4 un	PR: 48 un	-

Complementos necesarios para la instalación / Necessary materials for installation **Rendimiento Aprox. / Average Usage** **Precio / Price**

	○ MSA-70 Masilla Juntas Blanco Italia	1 Cartucho 2 - 3 Paneles	-
	○ PTX-20 Pintura Blanco Italia	1 Spray 8 Paneles	-

Complementos opcionales para la instalación / Optional materials for installation **Rendimiento Aprox. / Average Usage** **Precio / Price**

	○ MSA-3 Masilla de Pegado	1 Cartucho 4 - 5 Paneles	-
--	---------------------------	--------------------------	---

PRODUCTO PRODUCT	COD.	DESCRIPCIÓN DESCRIPTION	KG			PR
PR	1011	Panel Ashford Blanco Envejecido	PR: 7-8 kg	PR: 4 un	PR: 48 un	-

Complementos necesarios para la instalación / Necessary materials for installation **Rendimiento Aprox. / Average Usage** **Precio / Price**

	○ MSA-70 Masilla Juntas Blanco Italia	1 Cartucho 2 - 3 Paneles	-
	○ PTX-20 Pintura Blanco Italia	1 Spray 8 Paneles	-
	● PTE-22 Spray Envejecido Gris	1 Spray 15 Paneles	-

Complementos opcionales para la instalación / Optional materials for installation **Rendimiento Aprox. / Average Usage** **Precio / Price**

	○ MSA-3 Masilla de Pegado	1 Cartucho 4 - 5 Paneles	-
--	---------------------------	--------------------------	---

PRODUCTO PRODUCT	COD.	DESCRIPCIÓN DESCRIPTION	KG			PR
PR	1012	Panel Ashford Decape Ocre	PR: 7-8 kg	PR: 4 un	PR: 48 un	-

Complementos necesarios para la instalación / Necessary materials for installation **Rendimiento Aprox. / Average Usage** **Precio / Price**

	○ MSA-70 Masilla Juntas Blanco Italia	1 Cartucho 2 - 3 Paneles	-
	○ PTX-71 Blanco Italia Decape	1 Spray 8 Paneles	-
	● PTX-72 Pintura Decape Ocre	1 Spray 15 Paneles	-

Complementos opcionales para la instalación / Optional materials for installation **Rendimiento Aprox. / Average Usage** **Precio / Price**

	○ MSA-3 Masilla de Pegado	1 Cartucho 4 - 5 Paneles	-
--	---------------------------	--------------------------	---

Vintage ASHFORD

ACABADOS / FINISHES



1010
Blanco Italia /
Italian White



1011
Blanco Envejecido /
Aged White



1012
Decapé Ocre /
Ochre Decape



1013
Decapé Marrón /
Brown Decape



1014
Decapé Gris /
Grey Decape

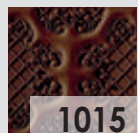

1015
Óxido / Rusty

MEDIDAS / MEASUREMENTS

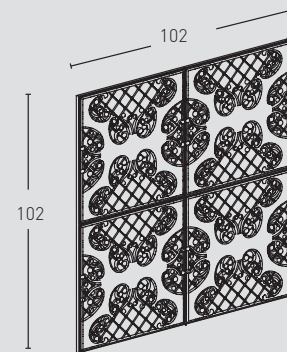
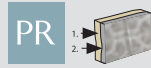

2 mín.
3,5 máx.



1 m²

Las medidas pueden variar +/-1cm / Measurements may vary +/-1cm

PRODUCTO PRODUCT	COD.	DESCRIPCIÓN DESCRIPTION	KG			PR
PR	1013	Panel Ashford Decape Marrón	PR: 7-8 kg	PR: 4 un	PR: 48 un	-

Complementos necesarios para la instalación / Necessary materials for installation			Rendimiento Aprox. / Average Usage		Precio / Price
	<input type="checkbox"/>	MSA-70 Masilla Juntas Blanco Italia	1	Cartucho 2 - 3 Paneles	-
	<input type="checkbox"/>	PTX-71 Blanco Italia Decape	1	Spray 8 Paneles	-
	<input checked="" type="checkbox"/>	PTX-73 Pintura Decape Marrón	1	Spray 15 Paneles	-

Complementos opcionales para la instalación / Optional materials for installation			Rendimiento Aprox. / Average Usage		Precio / Price
	<input type="checkbox"/>	MSA-3 Masilla de Pegado	1	Cartucho 4 - 5 Paneles	-

PRODUCTO PRODUCT	COD.	DESCRIPCIÓN DESCRIPTION	KG			PR
PR	1014	Panel Ashford Decape Gris	PR: 7-8 kg	PR: 4 un	PR: 48 un	-

Complementos necesarios para la instalación / Necessary materials for installation			Rendimiento Aprox. / Average Usage		Precio / Price
	<input type="checkbox"/>	MSA-70 Masilla Juntas Blanco Italia	1	Cartucho 2 - 3 Paneles	-
	<input type="checkbox"/>	PTX-71 Blanco Italia Decape	1	Spray 8 Paneles	-
	<input checked="" type="checkbox"/>	PTX-74 Pintura Decape Gris	1	Spray 15 Paneles	-

Complementos opcionales para la instalación / Optional materials for installation			Rendimiento Aprox. / Average Usage		Precio / Price
	<input type="checkbox"/>	MSA-3 Masilla de Pegado	1	Cartucho 4 - 5 Paneles	-

PRODUCTO PRODUCT	COD.	DESCRIPCIÓN DESCRIPTION	KG			PR
PR	1015	Panel Ashford Óxido	PR: 7-8 kg	PR: 4 un	PR: 48 un	-

Complementos necesarios para la instalación / Necessary materials for installation			Rendimiento Aprox. / Average Usage		Precio / Price
	<input checked="" type="checkbox"/>	MSA-60 Masilla Juntas Antracita	1	Cartucho 2 - 3 Paneles	-
	<input checked="" type="checkbox"/>	PTX-24 Pintura Óxido Metal	1	Spray 8 Paneles	-
	<input checked="" type="checkbox"/>	PTE-28 Envejecido Óxido + Compó (Bote)	1	Spray 8 Paneles	-
	<input type="checkbox"/>	BR-01 Spray Protector de Óxido	1	Spray 20 Paneles	-

Complementos opcionales para la instalación / Optional materials for installation			Rendimiento Aprox. / Average Usage		Precio / Price
	<input type="checkbox"/>	MSA-3 Masilla de Pegado	1	Cartucho 4 - 5 Paneles	-

Vintage ALHAMBRA®

(2016 Patented Design©)

PANELPIEDRA®

PR



PR 1005 Óxido



PR 1001 Blanco Envejecido

Vintage ALHAMBRA

ACABADOS / FINISHES



1000
Blanco Italia / Italian White



1001
Blanco Envejecido / Aged White



1002
Decapé Ocre / Ochre Decape



1003
Decapé Marrón / Brown Decape



1004
Decapé Gris / Grey Decape

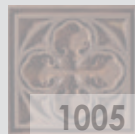

1005
Óxido / Rusty

MEDIDAS / MEASUREMENTS

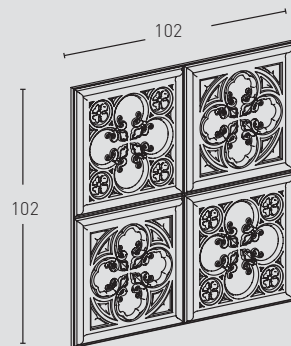

2,5 mín.
4 máx.



1 m²

Las medidas pueden variar +/-1cm / Measurements may vary +/-1cm

PRODUCTO PRODUCT	COD.	DESCRIPCIÓN DESCRIPTION	KG			PR
PR	1000	Panel Alhambra Blanco Italia	PR: 8-9 kg	PR: 4 un	PR: 48 un	-

Complementos necesarios para la instalación / Necessary materials for installation

Rendimiento Aprox. / Average Usage	Precio / Price
1 Cartucho 2 - 3 Paneles	-
1 Spray 8 Paneles	-

Complementos opcionales para la instalación / Optional materials for installation

Rendimiento Aprox. / Average Usage	Precio / Price
1 Cartucho 4 - 5 Paneles	-

PRODUCTO PRODUCT	COD.	DESCRIPCIÓN DESCRIPTION	KG			PR
PR	1001	Panel Alhambra Blanco Envejecido	PR: 8-9 kg	PR: 4 un	PR: 48 un	-

Complementos necesarios para la instalación / Necessary materials for installation

Rendimiento Aprox. / Average Usage	Precio / Price
1 Cartucho 2 - 3 Paneles	-
1 Spray 8 Paneles	-
1 Spray 15 Paneles	-

Complementos opcionales para la instalación / Optional materials for installation

Rendimiento Aprox. / Average Usage	Precio / Price
1 Cartucho 4 - 5 Paneles	-

PRODUCTO PRODUCT	COD.	DESCRIPCIÓN DESCRIPTION	KG			PR
PR	1002	Panel Alhambra Decape Ocre	PR: 8-9 kg	PR: 4 un	PR: 48 un	-

Complementos necesarios para la instalación / Necessary materials for installation

Rendimiento Aprox. / Average Usage	Precio / Price
1 Cartucho 2 - 3 Paneles	-
1 Spray 8 Paneles	-
1 Spray 15 Paneles	-

Complementos opcionales para la instalación / Optional materials for installation

Rendimiento Aprox. / Average Usage	Precio / Price
1 Cartucho 4 - 5 Paneles	-

Vintage ALHAMBRA

ACABADOS / FINISHES



1000
Blanco Italia /
Italian White



1001
Blanco Envejecido /
Aged White



1002
Decapé Ocre /
Ochre Decape



1003
Decapé Marrón /
Brown Decape



1004
Decapé Gris /
Grey Decape

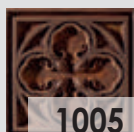

1005
Óxido / Rusty

MEDIDAS / MEASUREMENTS

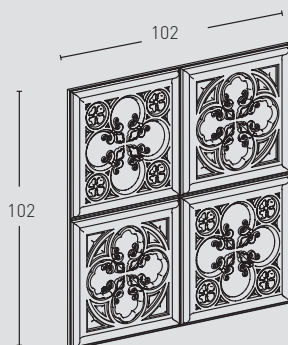

2,5 mín.
4 máx.



1 m²

Las medidas pueden variar +/- 1cm / Measurements may vary +/- 1cm

PRODUCTO PRODUCT	COD.	DESCRIPCIÓN DESCRIPTION	KG			PR	€/unidad
PR	1003	Panel Alhambra Decape Marrón	PR: 8-9 kg	PR: 4 un	PR: 48 un	-	-
Complementos necesarios para la instalación / Necessary materials for installation			Rendimiento Aprox. / Average Usage		Precio / Price		
	<input type="checkbox"/>	MSA-70 Masilla Juntas Blanco Italia	1 Cartucho 2 - 3 Paneles		-		
	<input type="checkbox"/>	PTX-71 Blanco Italia Decape	1 Spray 8 Paneles		-		
	<input checked="" type="checkbox"/>	PTX-73 Pintura Decape Marrón	1 Spray 15 Paneles		-		
Complementos opcionales para la instalación / Optional materials for installation			Rendimiento Aprox. / Average Usage		Precio / Price		
	<input type="checkbox"/>	MSA-3 Masilla de Pegado	1 Cartucho 4 - 5 Paneles		-		
PRODUCTO PRODUCT	COD.	DESCRIPCIÓN DESCRIPTION	KG			PR	€/unidad
PR	1004	Panel Alhambra Decape Gris	PR: 8-9 kg	PR: 4 un	PR: 48 un	-	-
Complementos necesarios para la instalación / Necessary materials for installation			Rendimiento Aprox. / Average Usage		Precio / Price		
	<input type="checkbox"/>	MSA-70 Masilla Juntas Blanco Italia	1 Cartucho 2 - 3 Paneles		-		
	<input type="checkbox"/>	PTX-71 Blanco Italia Decape	1 Spray 8 Paneles		-		
	<input checked="" type="checkbox"/>	PTX-74 Pintura Decape Gris	1 Spray 15 Paneles		-		
Complementos opcionales para la instalación / Optional materials for installation			Rendimiento Aprox. / Average Usage		Precio / Price		
	<input type="checkbox"/>	MSA-3 Masilla de Pegado	1 Cartucho 4 - 5 Paneles		-		
PRODUCTO PRODUCT	COD.	DESCRIPCIÓN DESCRIPTION	KG			PR	€/unidad
PR	1005	Panel Alhambra Óxido	PR: 8-9 kg	PR: 4 un	PR: 48 un	-	-
Complementos necesarios para la instalación / Necessary materials for installation			Rendimiento Aprox. / Average Usage		Precio / Price		
	<input checked="" type="checkbox"/>	MSA-60 Masilla Juntas Antracita	1 Cartucho 2 - 3 Paneles		-		
	<input checked="" type="checkbox"/>	PTX-24 Pintura Óxido Metal	1 Spray 8 Paneles		-		
	<input checked="" type="checkbox"/>	PTE-28 Envejecido Óxido + Compó (Bote)	1 Spray 8 Paneles		-		
	<input type="checkbox"/>	BR-01 Spray Protector de Óxido	1 Spray 15 Paneles		-		
Complementos opcionales para la instalación / Optional materials for installation			Rendimiento Aprox. / Average Usage		Precio / Price		
	<input type="checkbox"/>	MSA-3 Masilla de Pegado	1 Cartucho 4 - 5 Paneles		-		

VINTAGE

Vintage BLAIR®

(2016 Patented Design©)

PANELPIEDRA®

PR

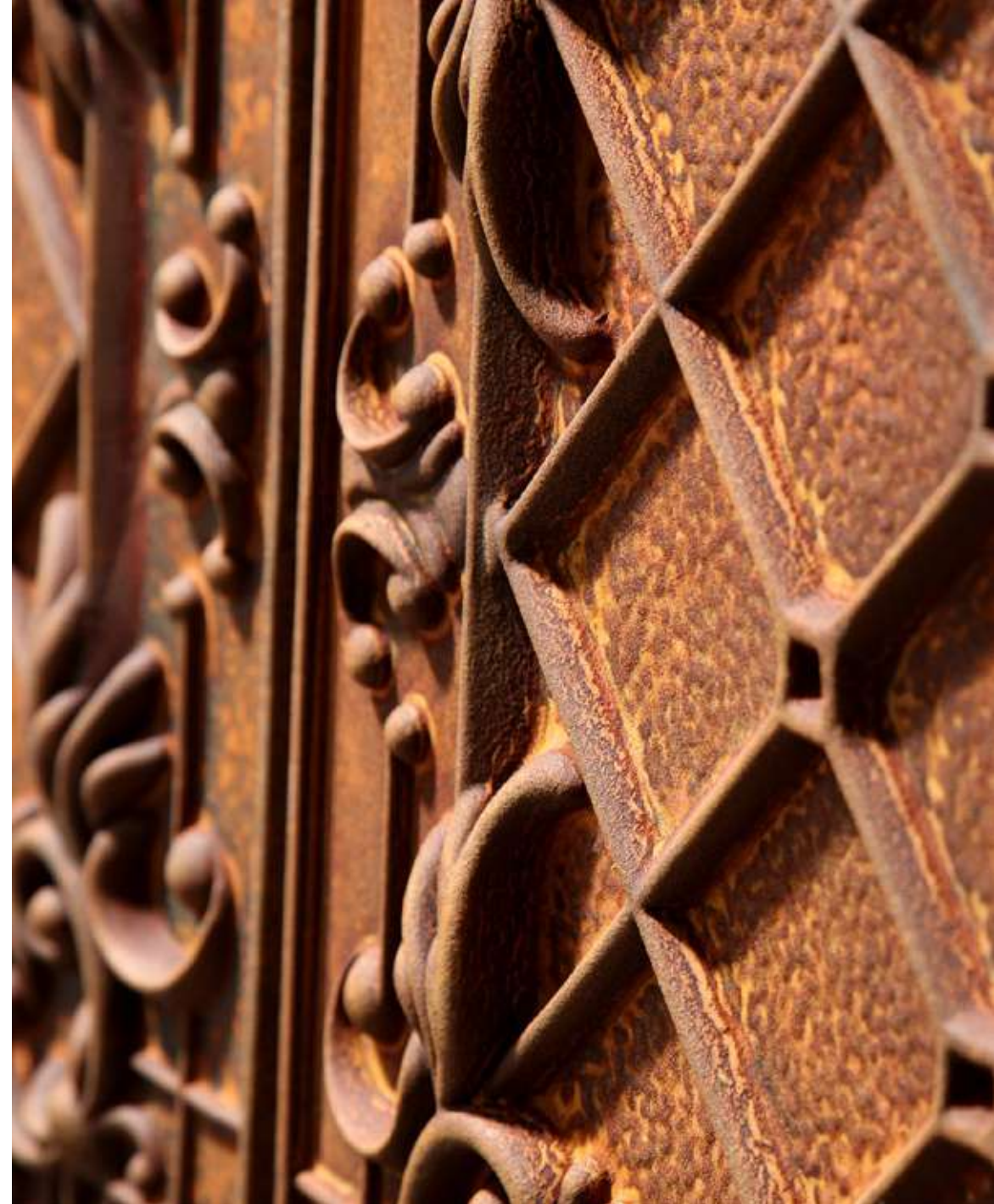

PR 1035 Óxido



VINTAGE

PR 1031 Blanco Envejecido

Vintage BLAIR

ACABADOS / FINISHES



1030
Blanco Italia /
Italian White



1031
Blanco Envejecido /
Aged White



1032
Decapé Ocre /
Ochre Decape

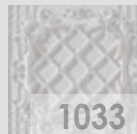

1033
Decapé Marrón /
Brown Decape



1034
Decapé Gris /
Grey Decape

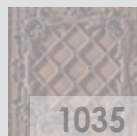

1035
Óxido / Rusty

MEDIDAS / MEASUREMENTS

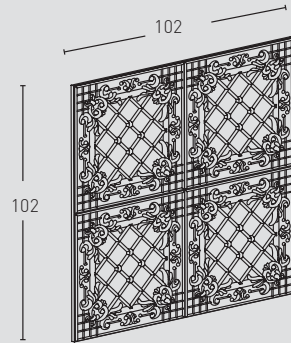

2 mín.
3,5 máx.



1 m²

Las medidas pueden variar +/-1cm / Measurements may vary +/-1cm

PRODUCTO PRODUCT	COD.	DESCRIPCIÓN DESCRIPTION	KG			PR
PR	1030	Panel Blair Blanco Italia	PR: 7-8 kg	PR: 4 un	PR: 48 un	-

Complementos necesarios para la instalación / Necessary materials for installation **Rendimiento Aprox. / Average Usage** **Precio / Price**

MSA-70 Masilla Juntas Blanco Italia	1 Cartucho 2 - 3 Paneles	-
PTX-20 Pintura Blanco Italia	1 Spray 8 Paneles	-

Complementos opcionales para la instalación / Optional materials for installation **Rendimiento Aprox. / Average Usage** **Precio / Price**

MSA-3 Masilla de Pegado	1 Cartucho 4 - 5 Paneles	-
-------------------------	--------------------------	---

PRODUCTO PRODUCT	COD.	DESCRIPCIÓN DESCRIPTION	KG			PR
PR	1031	Panel Blair Blanco Envejecido	PR: 7-8 kg	PR: 4 un	PR: 48 un	-

Complementos necesarios para la instalación / Necessary materials for installation **Rendimiento Aprox. / Average Usage** **Precio / Price**

MSA-70 Masilla Juntas Blanco Italia	1 Cartucho 2 - 3 Paneles	-
PTX-20 Pintura Blanco Italia	1 Spray 8 Paneles	-
PTE-22 Spray Envejecido Gris	1 Spray 15 Paneles	-

Complementos opcionales para la instalación / Optional materials for installation **Rendimiento Aprox. / Average Usage** **Precio / Price**

MSA-3 Masilla de Pegado	1 Cartucho 4 - 5 Paneles	-
-------------------------	--------------------------	---

PRODUCTO PRODUCT	COD.	DESCRIPCIÓN DESCRIPTION	KG			PR
PR	1032	Panel Blair Decape Ocre	PR: 7-8 kg	PR: 4 un	PR: 48 un	-

Complementos necesarios para la instalación / Necessary materials for installation **Rendimiento Aprox. / Average Usage** **Precio / Price**

MSA-70 Masilla Juntas Blanco Italia	1 Cartucho 2 - 3 Paneles	-
PTX-71 Blanco Italia Decape	1 Spray 8 Paneles	-
PTX-72 Pintura Decape Ocre	1 Spray 15 Paneles	-

Complementos opcionales para la instalación / Optional materials for installation **Rendimiento Aprox. / Average Usage** **Precio / Price**

MSA-3 Masilla de Pegado	1 Cartucho 4 - 5 Paneles	-
-------------------------	--------------------------	---

Vintage BLAIR

ACABADOS / FINISHES



1030
Blanco Italia / Italian White

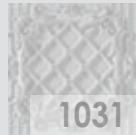

1031
Blanco Envejecido / Aged White

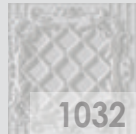

1032
Decapé Ocre / Ochre Decape



1033
Decapé Marrón / Brown Decape

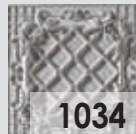

1034
Decapé Gris / Grey Decape

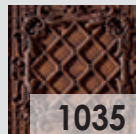

1035
Óxido / Rusty

MEDIDAS / MEASUREMENTS

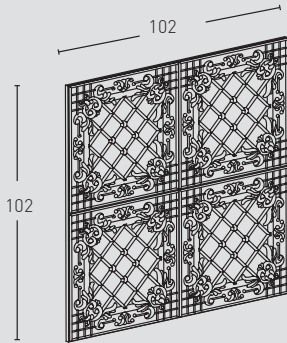

2 mín.
3,5 máx.



1 m²

Las medidas pueden variar +/- 1cm / Measurements may vary +/- 1cm

PRODUCTO PRODUCT	COD.	DESCRIPCIÓN DESCRIPTION	KG			PR	€/unidad
PR	1033	Panel Blair Decape Marrón	PR: 7-8 kg	PR: 4 un	PR: 48 un	-	-
Complementos necesarios para la instalación / Necessary materials for installation				Rendimiento Aprox. / Average Usage		Precio / Price	
○ MSA-70 Masilla Juntas Blanco Italia ○ PTX-71 Blanco Italia Decape ● PTX-73 Pintura Decape Marrón			1 Cartucho 2 - 3 Paneles		-		
			1 Spray 8 Paneles		-		
			1 Spray 15 Paneles		-		
Complementos opcionales para la instalación / Optional materials for installation				Rendimiento Aprox. / Average Usage		Precio / Price	
○ MSA-3 Masilla de Pegado			1 Cartucho 4 - 5 Paneles		-		
PRODUCTO PRODUCT	COD.	DESCRIPCIÓN DESCRIPTION	KG			PR	€/unidad
PR	1034	Panel Blair Decape Gris	PR: 7-8 kg	PR: 4 un	PR: 48 un	-	-
Complementos necesarios para la instalación / Necessary materials for installation				Rendimiento Aprox. / Average Usage		Precio / Price	
○ MSA-70 Masilla Juntas Blanco Italia ○ PTX-71 Blanco Italia Decape ● PTX-74 Pintura Decape Gris			1 Cartucho 2 - 3 Paneles		-		
			1 Spray 8 Paneles		-		
			1 Spray 15 Paneles		-		
Complementos opcionales para la instalación / Optional materials for installation				Rendimiento Aprox. / Average Usage		Precio / Price	
○ MSA-3 Masilla de Pegado			1 Cartucho 4 - 5 Paneles		-		
PRODUCTO PRODUCT	COD.	DESCRIPCIÓN DESCRIPTION	KG			PR	€/unidad
PR	1035	Panel Blair Óxido	PR: 7-8 kg	PR: 4 un	PR: 48 un	-	-
Complementos necesarios para la instalación / Necessary materials for installation				Rendimiento Aprox. / Average Usage		Precio / Price	
● MSA-60 Masilla Juntas Antracita ● PTX-24 Pintura Óxido Metal ● PTE-28 Envejecido Óxido + Compó (Bote) ○ BR-01 Spray Protector de Óxido			1 Cartucho 2 - 3 Paneles		-		
			1 Spray 8 Paneles		-		
			1 Spray 8 Paneles		-		
			1 Spray 15 Paneles		-		
Complementos opcionales para la instalación / Optional materials for installation				Rendimiento Aprox. / Average Usage		Precio / Price	
○ MSA-3 Masilla de Pegado			1 Cartucho 4 - 5 Paneles		-		

VINTAGE

Vintage BELVER®

(2016 Patented Design©)

PANELPIEDRA®

PR



PR 1024 Decapé Gris



PR 1020 Blanco Italia

Vintage BELVER

ACABADOS / FINISHES



1020
Blanco Italia /
Italian White



1021
Blanco Envejecido /
Aged White



1022
Decapé Ocre /
Ochre Decape



1023
Decapé Marrón /
Brown Decape



1024
Decapé Gris /
Grey Decape

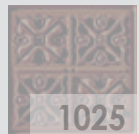

1025
Óxido / Rusty

MEDIDAS / MEASUREMENTS

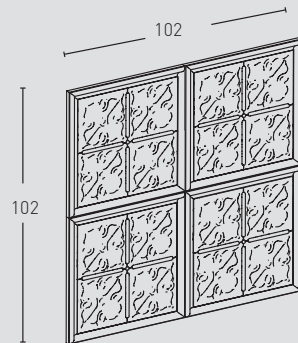

2 mín.
3,5 máx.



1 m²

Las medidas pueden variar +/-1cm / Measurements may vary +/-1cm

PRODUCTO PRODUCT	COD.	DESCRIPCIÓN DESCRIPTION	KG			PR
PR	1020	Panel Belver Blanco Italia	PR: 7-8 kg	PR: 4 un	PR: 48 un	-

Complementos necesarios para la instalación / Necessary materials for installation **Rendimiento Aprox. / Average Usage** **Precio / Price**

MSA-70 Masilla Juntas Blanco Italia	1 Cartucho 2 - 3 Paneles	-
PTX-20 Pintura Blanco Italia	1 Spray 8 Paneles	-

Complementos opcionales para la instalación / Optional materials for installation **Rendimiento Aprox. / Average Usage** **Precio / Price**

MSA-3 Masilla de Pegado	1 Cartucho 4 - 5 Paneles	-
-------------------------	--------------------------	---

PRODUCTO PRODUCT	COD.	DESCRIPCIÓN DESCRIPTION	KG			PR
PR	1021	Panel Belver Blanco Envejecido	PR: 7-8 kg	PR: 4 un	PR: 48 un	-

Complementos necesarios para la instalación / Necessary materials for installation **Rendimiento Aprox. / Average Usage** **Precio / Price**

MSA-70 Masilla Juntas Blanco Italia	1 Cartucho 2 - 3 Paneles	-
PTX-20 Pintura Blanco Italia	1 Spray 8 Paneles	-
PTE-22 Spray Envejecido Gris	1 Spray 15 Paneles	-

Complementos opcionales para la instalación / Optional materials for installation **Rendimiento Aprox. / Average Usage** **Precio / Price**

MSA-3 Masilla de Pegado	1 Cartucho 4 - 5 Paneles	-
-------------------------	--------------------------	---

PRODUCTO PRODUCT	COD.	DESCRIPCIÓN DESCRIPTION	KG			PR
PR	1022	Panel Belver Decape Ocre	PR: 7-8 kg	PR: 4 un	PR: 48 un	-

Complementos necesarios para la instalación / Necessary materials for installation **Rendimiento Aprox. / Average Usage** **Precio / Price**

MSA-70 Masilla Juntas Blanco Italia	1 Cartucho 2 - 3 Paneles	-
PTX-71 Blanco Italia Decape	1 Spray 15 Paneles	-
PTX-72 Pintura Decape Ocre	1 Spray 15 Paneles	-

Complementos opcionales para la instalación / Optional materials for installation **Rendimiento Aprox. / Average Usage** **Precio / Price**

MSA-3 Masilla de Pegado	1 Cartucho 4 - 5 Paneles	-
-------------------------	--------------------------	---

Vintage BELVER

ACABADOS / FINISHES



1020

Blanco Italia / Italian White



1021

Blanco Envejecido / Aged White



1022

Decapé Ocre / Ochre Decape



1023

Decapé Marrón / Brown Decape



1024

Decapé Gris / Grey Decape



1025

Óxido / Rusty

MEDIDAS / MEASUREMENTS

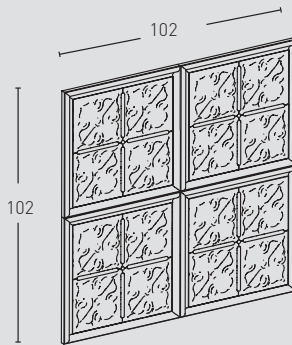
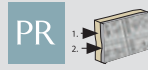

2 mín.
3,5 máx.



1 m²

Las medidas pueden variar +/- 1cm / Measurements may vary +/- 1cm

PRODUCTO PRODUCT	COD.	DESCRIPCIÓN DESCRIPTION	KG			PR	€/unidad
PR	1023	Panel Belver Decape Marrón	PR: 7-8 kg	PR: 4 un	PR: 48 un	-	-

Complementos necesarios para la instalación / Necessary materials for installation			Rendimiento Aprox. / Average Usage		Precio / Price
	<input type="checkbox"/>	MSA-70 Masilla Juntas Blanco Italia	1	Cartucho 2 - 3 Paneles	-
	<input type="checkbox"/>	PTX-71 Blanco Italia Decape	1	Spray 8 Paneles	-
	<input type="checkbox"/>	PTX-73 Pintura Decape Marrón	1	Spray 15 Paneles	-

Complementos opcionales para la instalación / Optional materials for installation			Rendimiento Aprox. / Average Usage		Precio / Price
	<input type="checkbox"/>	MSA-3 Masilla de Pegado	1	Cartucho 4 - 5 Paneles	-

PRODUCTO PRODUCT	COD.	DESCRIPCIÓN DESCRIPTION	KG			PR	€/unidad
PR	1024	Panel Belver Decape Gris	PR: 7-8 kg	PR: 4 un	PR: 48 un	-	-

Complementos necesarios para la instalación / Necessary materials for installation			Rendimiento Aprox. / Average Usage		Precio / Price
	<input type="checkbox"/>	MSA-70 Masilla Juntas Blanco Italia	1	Cartucho 2 - 3 Paneles	-
	<input type="checkbox"/>	PTX-71 Blanco Italia Decape	1	Spray 8 Paneles	-
	<input type="checkbox"/>	PTX-74 Pintura Decape Gris	1	Spray 15 Paneles	-

Complementos opcionales para la instalación / Optional materials for installation			Rendimiento Aprox. / Average Usage		Precio / Price
	<input type="checkbox"/>	MSA-3 Masilla de Pegado	1	Cartucho 4 - 5 Paneles	-

PRODUCTO PRODUCT	COD.	DESCRIPCIÓN DESCRIPTION	KG			PR	€/unidad
PR	1025	Panel Belver Óxido	PR: 7-8 kg	PR: 4 un	PR: 48 un	-	-

Complementos necesarios para la instalación / Necessary materials for installation			Rendimiento Aprox. / Average Usage		Precio / Price
	<input type="checkbox"/>	MSA-60 Masilla Juntas Antracita	1	Cartucho 2 - 3 Paneles	-
	<input type="checkbox"/>	PTX-24 Pintura Óxido Metal	1	Spray 8 Paneles	-
	<input type="checkbox"/>	PTE-28 Envejecido Óxido + Compó (Bote)	1	Spray 8 Paneles	-
	<input type="checkbox"/>	BR-01 Spray Protector de Óxido	1	Spray 8 Paneles	-

Complementos opcionales para la instalación / Optional materials for installation			Rendimiento Aprox. / Average Usage		Precio / Price
	<input type="checkbox"/>	MSA-3 Masilla de Pegado	1	Cartucho 4 - 5 Paneles	-

Vintage LOIRA®

(2016 Patented Design©)

PANELPIEDRA®

PR



PR 1052 Decapé Ocre



PR 1052 Decapé Ocre

Vintage LOIRA

ACABADOS / FINISHES



1050

Blanco Italia / Italian White



1051

Blanco Envejecido / Aged White



1052

Decapé Ocre / Ochre Decape



1053

Decapé Marrón / Brown Decape

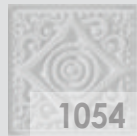

1054

Decapé Gris / Grey Decape

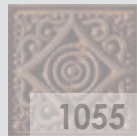

1055

Óxido / Rusty

MEDIDAS / MEASUREMENTS

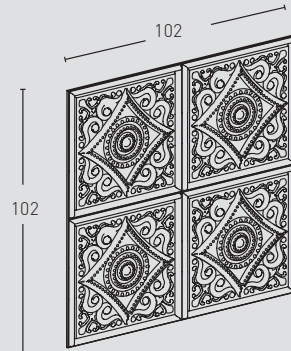

102

2 mín.
3,5 máx.



1 m²

Las medidas pueden variar +/-1cm / Measurements may vary +/-1cm

PRODUCTO PRODUCT	COD.	DESCRIPCIÓN DESCRIPTION	KG			PR
PR	1050	Panel Loira Blanco Italia	PR: 7-8 kg	PR: 4 un	PR: 48 un	-

Complementos necesarios para la instalación / Necessary materials for installation **Rendimiento Aprox. / Average Usage** **Precio / Price**

MSA-70 Masilla Juntas Blanco Italia	1 Cartucho 2 - 3 Paneles	-
PTX-20 Pintura Blanco Italia	1 Spray 8 Paneles	-

Complementos opcionales para la instalación / Optional materials for installation **Rendimiento Aprox. / Average Usage** **Precio / Price**

MSA-3 Masilla de Pegado	1 Cartucho 4 - 5 Paneles	-
-------------------------	--------------------------	---

PRODUCTO PRODUCT	COD.	DESCRIPCIÓN DESCRIPTION	KG			PR
PR	1051	Panel Loira Blanco Envejecido	PR: 7-8 kg	PR: 4 un	PR: 48 un	-

Complementos necesarios para la instalación / Necessary materials for installation **Rendimiento Aprox. / Average Usage** **Precio / Price**

MSA-70 Masilla Juntas Blanco Italia	1 Cartucho 2 - 3 Paneles	-
PTX-20 Pintura Blanco Italia	1 Spray 8 Paneles	-
PTE-22 Spray Envejecido Gris	1 Spray 15 Paneles	-

Complementos opcionales para la instalación / Optional materials for installation **Rendimiento Aprox. / Average Usage** **Precio / Price**

MSA-3 Masilla de Pegado	1 Cartucho 4 - 5 Paneles	-
-------------------------	--------------------------	---

PRODUCTO PRODUCT	COD.	DESCRIPCIÓN DESCRIPTION	KG			PR
PR	1052	Panel Loira Decape Ocre	PR: 7-8 kg	PR: 4 un	PR: 48 un	-

Complementos necesarios para la instalación / Necessary materials for installation **Rendimiento Aprox. / Average Usage** **Precio / Price**

MSA-70 Masilla Juntas Blanco Italia	1 Cartucho 2 - 3 Paneles	-
PTX-71 Blanco Italia Decape	1 Spray 8 Paneles	-
PTX-72 Pintura Decape Ocre	1 Spray 15 Paneles	-

Complementos opcionales para la instalación / Optional materials for installation **Rendimiento Aprox. / Average Usage** **Precio / Price**

MSA-3 Masilla de Pegado	1 Cartucho 4 - 5 Paneles	-
-------------------------	--------------------------	---

Vintage LOIRA

ACABADOS / FINISHES



1050
Blanco Italia /
Italian White

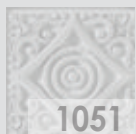

1051
Blanco Envejecido /
Aged White

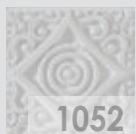

1052
Decapé Ocre /
Ochre Decape



1053
Decapé Marrón /
Brown Decape



1054
Decapé Gris /
Grey Decape

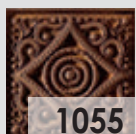

1055
Óxido / Rusty

MEDIDAS / MEASUREMENTS

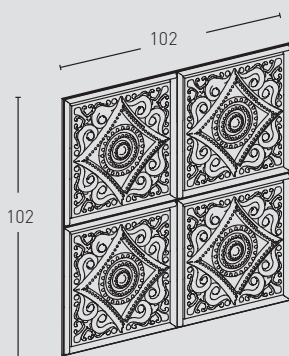

2 mín.
3,5 máx.



1 m²

Las medidas pueden variar +/- 1cm / Measurements may vary +/- 1cm

PRODUCTO PRODUCT	COD.	DESCRIPCIÓN DESCRIPTION	KG			PR
PR	1053	Panel Loira Decape Marrón	PR: 7-8 kg	PR: 4 un	PR: 48 un	-

Complementos necesarios para la instalación / Necessary materials for installation



- MSA-70 Masilla Juntas Blanco Italia
- PTX-71 Blanco Italia Decape
- PTX-73 Pintura Decape Marrón

Rendimiento Aprox. / Average Usage

- 1 Cartucho 2 - 3 Paneles
- 1 Spray 8 Paneles
- 1 Spray 15 Paneles

Precio / Price

€/unidad

Complementos opcionales para la instalación / Optional materials for installation



- MSA-3 Masilla de Pegado

Rendimiento Aprox. / Average Usage

- 1 Cartucho 4 - 5 Paneles

Precio / Price

-

PRODUCTO PRODUCT	COD.	DESCRIPCIÓN DESCRIPTION	KG			PR
PR	1054	Panel Loira Decape Gris	PR: 7-8 kg	PR: 4 un	PR: 48 un	-

Complementos necesarios para la instalación / Necessary materials for installation



- MSA-70 Masilla Juntas Blanco Italia
- PTX-71 Blanco Italia Decape
- PTX-74 Pintura Decape Gris

Rendimiento Aprox. / Average Usage

- 1 Cartucho 2 - 3 Paneles
- 1 Spray 8 Paneles
- 1 Spray 15 Paneles

Precio / Price

€/unidad

Complementos opcionales para la instalación / Optional materials for installation



- MSA-3 Masilla de Pegado

Rendimiento Aprox. / Average Usage

- 1 Cartucho 4 - 5 Paneles

Precio / Price

-

PRODUCTO PRODUCT	COD.	DESCRIPCIÓN DESCRIPTION	KG			PR
PR	1055	Panel Loira Óxido	PR: 7-8 kg	PR: 4 un	PR: 48 un	-

Complementos necesarios para la instalación / Necessary materials for installation



- MSA-60 Masilla Juntas Antracita
- PTX-24 Pintura Óxido Metal
- PTE-28 Envejecido Óxido + Compó (Bote)
- BR-01 Spray Protector de Óxido

Rendimiento Aprox. / Average Usage

- 1 Cartucho 2 - 3 Paneles
- 1 Spray 8 Paneles
- 1 Spray 8 Paneles
- 1 Spray 15 Paneles

Precio / Price

€/unidad

Complementos opcionales para la instalación / Optional materials for installation



- MSA-3 Masilla de Pegado

Rendimiento Aprox. / Average Usage

- 1 Cartucho 4 - 5 Paneles

Precio / Price

-

Vintage CHANTILLY®

(2016 Patented Design©)

PANELPIEDRA®

PR



PR 1040 Blanco Italia



PR 1041 Blanco Envejecido

Vintage CHANTILLY

ACABADOS / FINISHES



1040
Blanco Italia / Italian White



1041
Blanco Envejecido / Aged White

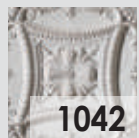

1042
Decapé Ocre / Ochre Decape

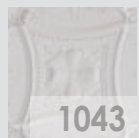

1043
Decapé Marrón / Brown Decape



1044
Decapé Gris / Grey Decape

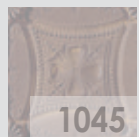

1045
Óxido / Rusty

MEDIDAS / MEASUREMENTS

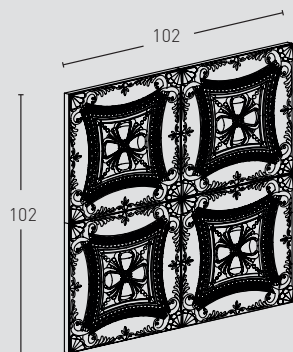

2 mín.
3,5 máx.



1 m²

Las medidas pueden variar +/-1cm / Measurements may vary +/-1cm

PRODUCTO PRODUCT	COD.	DESCRIPCIÓN DESCRIPTION	KG			PR
PR	1040	Panel Chantilly Blanco Italia	PR: 7-8 kg	PR: 4 un	PR: 48 un	-

Complementos necesarios para la instalación / Necessary materials for installation **Rendimiento Aprox. / Average Usage** **Precio / Price**

MSA-70 Masilla Juntas Blanco Italia	1 Cartucho 2 - 3 Paneles	-
PTX-20 Pintura Blanco Italia	1 Spray 8 Paneles	-

Complementos opcionales para la instalación / Optional materials for installation **Rendimiento Aprox. / Average Usage** **Precio / Price**

MSA-3 Masilla de Pegado	1 Cartucho 4 - 5 Paneles	-
-------------------------	--------------------------	---

PRODUCTO PRODUCT	COD.	DESCRIPCIÓN DESCRIPTION	KG			PR
PR	1041	Panel Chantilly Blanco Envejecido	PR: 7-8 kg	PR: 4 un	PR: 48 un	-

Complementos necesarios para la instalación / Necessary materials for installation **Rendimiento Aprox. / Average Usage** **Precio / Price**

MSA-70 Masilla Juntas Blanco Italia	1 Cartucho 2 - 3 Paneles	-
PTX-20 Pintura Blanco Italia	1 Spray 8 Paneles	-
PTE-22 Spray Envejecido Gris	1 Spray 15 Paneles	-

Complementos opcionales para la instalación / Optional materials for installation **Rendimiento Aprox. / Average Usage** **Precio / Price**

MSA-3 Masilla de Pegado	1 Cartucho 4 - 5 Paneles	-
-------------------------	--------------------------	---

PRODUCTO PRODUCT	COD.	DESCRIPCIÓN DESCRIPTION	KG			PR
PR	1042	Panel Chantilly Decape Ocre	PR: 7-8 kg	PR: 4 un	PR: 48 un	-

Complementos necesarios para la instalación / Necessary materials for installation **Rendimiento Aprox. / Average Usage** **Precio / Price**

MSA-70 Masilla Juntas Blanco Italia	1 Cartucho 2 - 3 Paneles	-
PTX-71 Blanco Italia Decape	1 Spray 8 Paneles	-
PTX-72 Pintura Decape Ocre	1 Spray 15 Paneles	-

Complementos opcionales para la instalación / Optional materials for installation **Rendimiento Aprox. / Average Usage** **Precio / Price**

MSA-3 Masilla de Pegado	1 Cartucho 4 - 5 Paneles	-
-------------------------	--------------------------	---

Vintage CHANTILLY

ACABADOS / FINISHES



1040
Blanco Italia /
Italian White



1041
Blanco Envejecido /
Aged White



1042
Decapé Ocre /
Ochre Decape

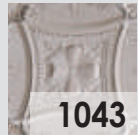

1043
Decapé Marrón /
Brown Decape



1044
Decapé Gris /
Grey Decape

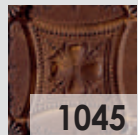

1045
Óxido / Rusty

MEDIDAS / MEASUREMENTS

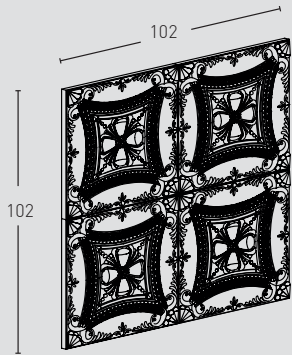

2 mín.
3,5 máx.



1 m²

Las medidas pueden variar +/- 1cm / Measurements may vary +/- 1cm

PRODUCTO PRODUCT	COD.	DESCRIPCIÓN DESCRIPTION	KG			PR	€/unidad
PR	1043	Panel Chantilly Decape Marrón	PR: 7-8 kg	PR: 4 un	PR: 48 un	-	
Complementos necesarios para la instalación / Necessary materials for installation			Rendimiento Aprox. / Average Usage		Precio / Price		
		○ MSA-70 Masilla Juntas Blanco Italia		1 Cartucho 2 - 3 Paneles		-	
		○ PTX-71 Blanco Italia Decape		1 Spray 8 Paneles		-	
		● PTX-73 Pintura Decape Marrón		1 Spray 15 Paneles		-	
Complementos opcionales para la instalación / Optional materials for installation			Rendimiento Aprox. / Average Usage		Precio / Price		
		○ MSA-3 Masilla de Pegado		1 Cartucho 4 - 5 Paneles		-	
PRODUCTO PRODUCT	COD.	DESCRIPCIÓN DESCRIPTION	KG			PR	€/unidad
PR	1044	Panel Chantilly Decape Gris	PR: 7-8 kg	PR: 4 un	PR: 48 un	-	
Complementos necesarios para la instalación / Necessary materials for installation			Rendimiento Aprox. / Average Usage		Precio / Price		
		○ MSA-70 Masilla Juntas Blanco Italia		1 Cartucho 2 - 3 Paneles		-	
		○ PTX-71 Blanco Italia Decape		1 Spray 8 Paneles		-	
		● PTX-74 Pintura Decape Gris		1 Spray 15 Paneles		-	
Complementos opcionales para la instalación / Optional materials for installation			Rendimiento Aprox. / Average Usage		Precio / Price		
		○ MSA-3 Masilla de Pegado		1 Cartucho 4 - 5 Paneles		-	
PRODUCTO PRODUCT	COD.	DESCRIPCIÓN DESCRIPTION	KG			PR	€/unidad
PR	1045	Panel Chantilly Óxido	PR: 7-8 kg	PR: 4 un	PR: 48 un	-	
Complementos necesarios para la instalación / Necessary materials for installation			Rendimiento Aprox. / Average Usage		Precio / Price		
		● MSA-60 Masilla Juntas Antracita		1 Cartucho 2 - 3 Paneles		-	
		● PTX-24 Pintura Óxido Metal		1 Spray 8 Paneles		-	
		● PTE-28 Envejecido Óxido + Compó (Bote)		1 Spray 8 Paneles		-	
		○ BR-01 Spray Protector de Óxido		1 Spray 15 Paneles		-	
Complementos opcionales para la instalación / Optional materials for installation			Rendimiento Aprox. / Average Usage		Precio / Price		
		○ MSA-3 Masilla de Pegado		1 Cartucho 4 - 5 Paneles		-	



BRICK[®]

Collection



BRICK[®]

Collection



LADRILLO VIEJO / 134-139



LADRILLO RÚSTICO / 140-145



LADRILLO ADOBE / 146-151



LADRILLO CARAVISTA / 152-155



LADRILLO LOFT / 156-161



LADRILLO OLD BRITISH / 162-167



LADRILLO BRITISH / 168-171



URBAN BRICK / 172-177

Brick
LADRILLO
VIEJO

PANELPIEDRA®

PR



PR 485 Arcilloso



BRICK

PR 481 Blanco



Brick
LADRILLO VIEJO

Brick LADRILLO VIEJO

ACABADOS / FINISHES

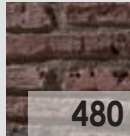

480

Envejecido /
Aged

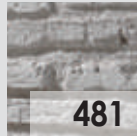

481

Blanco /
White

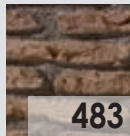

483

Junta Oscura /
Dark Grout

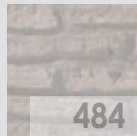

484

Terroso /
Earthy

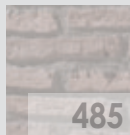

485

Arcilloso /
Clay



486

Terroso Caleado /
Earthy Whitewashed

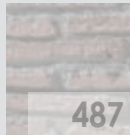

487

Arcilloso Caleado /
Clay Whitewashed

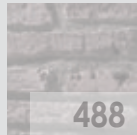

488

Envejec. Caleado /
Aged Whitewashed

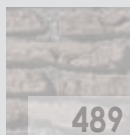

489

Junta Oscura Caleado /
Dark Grout Whitewashed

MEDIDAS / MEASUREMENTS

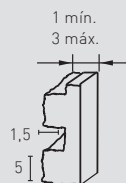
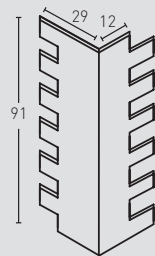
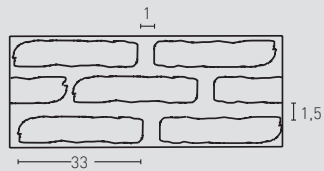
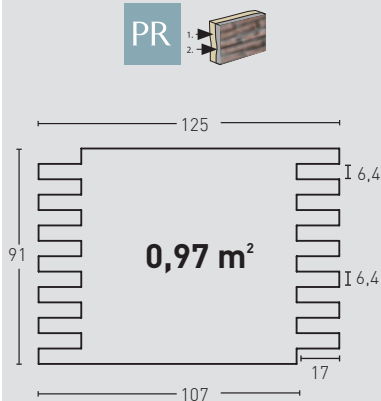

PRODUCTO PRODUCT	COD.	DESCRIPCIÓN DESCRIPTION	KG			PR
PR	480 480-E	Panel Ladrillo Viejo Envejecido	PR: 7-8 kg	PR: 4 un	PR: 48 un	€/unidad
		Ángulo Ladrillo Viejo Envejecido	PR: 3 kg	PR: 2 un	PR: 30 un	-

Complementos necesarios para la instalación / Necessary materials for installation

	Rendimiento Aprox. / Average Usage	Precio / Price
● MSA-50 Masilla Juntas Oscuro	1 Cartucho 2 - 3 Paneles	-
● PT-12 Pintura Junta Oscura	1 Bote 25 Paneles	-
● PTE-21 Pintura Envejecido Marrón	1 Spray 15 Paneles	-

Complementos opcionales para la instalación / Optional materials for installation

	Rendimiento Aprox. / Average Usage	Precio / Price
○ MSA-3 Masilla de Pegado	1 Cartucho 4 - 5 Paneles	-
● PTX-11 Pintura Rojo Viejo	1 Spray 15 Paneles	-

PRODUCTO PRODUCT	COD.	DESCRIPCIÓN DESCRIPTION	KG			PR
PR	481 481-E	Panel Ladrillo Viejo Blanco	PR: 7-8 kg	PR: 4 un	PR: 48 un	€/unidad
		Ángulo Ladrillo Viejo Blanco	PR: 3 kg	PR: 2 un	PR: 30 un	-

Complementos necesarios para la instalación / Necessary materials for installation

	Rendimiento Aprox. / Average Usage	Precio / Price
○ MSA-70 Masilla Juntas Blanco Italia	1 Cartucho 2 - 3 Paneles	-
○ PT-10 Pintura Blanco Nieve	1 Spray 8 Paneles	-

Complementos opcionales para la instalación / Optional materials for installation

	Rendimiento Aprox. / Average Usage	Precio / Price
○ MSA-3 Masilla de Pegado	1 Cartucho 4 - 5 Paneles	-

PRODUCTO PRODUCT	COD.	DESCRIPCIÓN DESCRIPTION	KG			PR
PR	483 483-E	Panel Ladrillo Viejo Junta Oscura	PR: 6-7 kg	PR: 4 un	PR: 48 un	€/unidad
		Ángulo Ladr. Viejo Junta Oscura	PR: 2-3 kg	PR: 4 un	PR: 60 un	-

Complementos necesarios para la instalación / Necessary materials for installation

	Rendimiento Aprox. / Average Usage	Precio / Price
● MSA-50 Masilla Juntas Oscuro	1 Cartucho 2 - 3 Paneles	-
● PT-12 Pintura Junta Oscura	1 Bote 25 Paneles	-
● PTE-21 Pintura Envejecido Marrón	1 Spray 15 Paneles	-

Complementos opcionales para la instalación / Optional materials for installation

	Rendimiento Aprox. / Average Usage	Precio / Price
○ MSA-3 Masilla de Pegado	1 Cartucho 2 - 4 Paneles	-
● PTE-24 Pintura Envejecido Rojo	1 Spray 15 Paneles	-
● PTX-04 Beige Ladrillo	1 Spray 15 Paneles	-

Brick LADRILLO VIEJO

ACABADOS / FINISHES

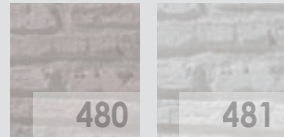

480
Envejecido /
Aged



481
Blanco /
White

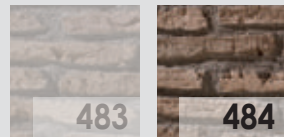

483
Junta Oscura /
Dark Grout

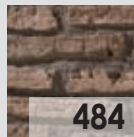

484
Terroso /
Earthi



485
Arcilloso /
Clay

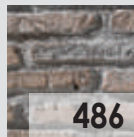

486
Terroso Caleado /
Earthi Whitewashed

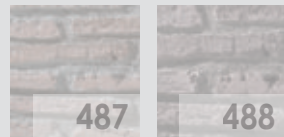

487
Arcilloso Caleado /
Clay Whitewashed

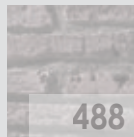

488
Envejec. Caleado /
Aged Whitewashed

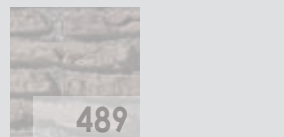

489
Junta Oscura Caleado /
Dark Grout Whitewashed

MEDIDAS / MEASUREMENTS

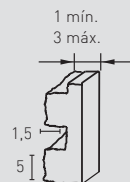
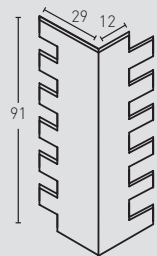
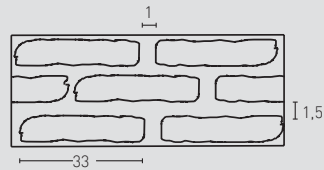
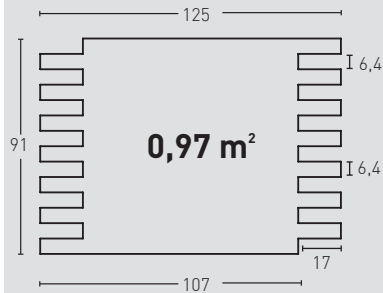
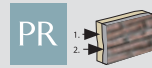

Las medidas pueden variar +/-1cm / Measurements may vary +/-1cm

PRODUCTO PRODUCT	COD.	DESCRIPCIÓN DESCRIPTION	KG			PR
PR	484 484-E	Panel Ladrillo Viejo Terroso Ángulo Ladrillo Viejo Terroso	PR: 7-8 kg PR: 3 kg	PR: 4 un PR: 2 un	PR: 48 un PR: 30 un	€/unidad - -

Complementos necesarios para la instalación / Necessary materials for installation

Complementos necesarios para la instalación / Necessary materials for installation	Rendimiento Aprox. / Average Usage	Precio / Price
● MSA-50 Masilla Juntas Oscuro	1 Cartucho 2 - 3 Paneles	-
● PT-12 Pintura Junta Oscura	1 Bote 25 Paneles	-
● PTE-21 Pintura Envejecido Marrón	1 Spray 15 Paneles	-

Complementos opcionales para la instalación / Optional materials for installation

Complementos opcionales para la instalación / Optional materials for installation	Rendimiento Aprox. / Average Usage	Precio / Price
○ MSA-3 Masilla de Pegado	1 Cartucho 4 - 5 Paneles	-
● PTX-32 Ladrillo Terroso	1 Spray 15 Paneles	-
● PTX-33 Ladrillo Terroso Oscuro	1 Spray 15 Paneles	-

PRODUCTO PRODUCT	COD.	DESCRIPCIÓN DESCRIPTION	KG			PR
PR	485 485-E	Panel Ladrillo Viejo Arcilloso Ángulo Ladrillo Viejo Arcilloso	PR: 7-8 kg PR: 3 kg	PR: 4 un PR: 2 un	PR: 48 un PR: 30 un	€/unidad - -

Complementos necesarios para la instalación / Necessary materials for installation

Complementos necesarios para la instalación / Necessary materials for installation	Rendimiento Aprox. / Average Usage	Precio / Price
● MSA-50 Masilla Juntas Oscuro	1 Cartucho 2 - 3 Paneles	-
● PT-12 Pintura Junta Oscura	1 Bote 8 Paneles	-
● PTE-21 Pintura Envejecido Marrón	1 Spray 15 Paneles	-

Complementos opcionales para la instalación / Optional materials for installation

Complementos opcionales para la instalación / Optional materials for installation	Rendimiento Aprox. / Average Usage	Precio / Price
○ MSA-3 Masilla de Pegado	1 Cartucho 4 - 5 Paneles	-
● PTX-34 Ladrillo Arcilloso	1 Spray 15 Paneles	-
● PTX-35 Ladrillo Arcilloso Oscuro	1 Spray 15 Paneles	-

PRODUCTO PRODUCT	COD.	DESCRIPCIÓN DESCRIPTION	KG			PR
PR	486 486-E	Panel Ladr. Viejo Terroso Caleado Ángulo Ladr. Viejo Terroso Caleado	PR: 6-7 kg PR: 2-3 kg	PR: 4 un PR: 4 un	PR: 48 un PR: 60 un	€/unidad - -

Complementos necesarios para la instalación / Necessary materials for installation

Complementos necesarios para la instalación / Necessary materials for installation	Rendimiento Aprox. / Average Usage	Precio / Price
● MSA-50 Masilla Juntas Oscuro	1 Cartucho 2 - 3 Paneles	-
● PT-12 Pintura Junta Oscura	1 Bote 8 Paneles	-
○ PTE-33 Pintura Envejecido Caleado + Comp6(Bote)	1 Spray 15 Paneles	-

Complementos opcionales para la instalación / Optional materials for installation

Complementos opcionales para la instalación / Optional materials for installation	Rendimiento Aprox. / Average Usage	Precio / Price
○ MSA-3 Masilla de Pegado	1 Cartucho 4 - 5 Paneles	-
● PTX-32 Ladrillo Terroso	1 Spray 15 Paneles	-
● PTX-21 Pintura Envejecido Marrón	1 Spray 15 Paneles	-

Brick LADRILLO VIEJO

ACABADOS / FINISHES

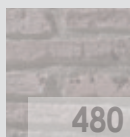

480
Envejecido /
Aged

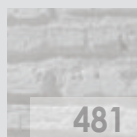

481
Blanco /
White

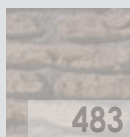

483
Junta Oscura /
Dark Grout

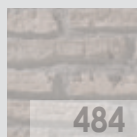

484
Terroso /
Earthy

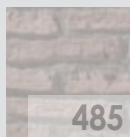

485
Arcilloso /
Clay



486
Terroso Caleado /
Earthy Whitewashed

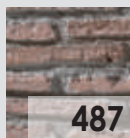

487
Arcilloso Caleado /
Clay Whitewashed

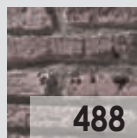

488
Envejec. Caleado /
Aged Whitewashed

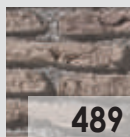

489
Junta Oscura Caleado /
Dark Grout Whitewashed

MEDIDAS / MEASUREMENTS

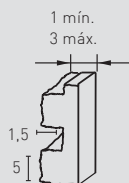
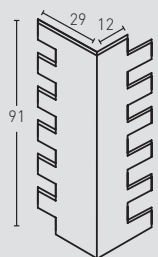
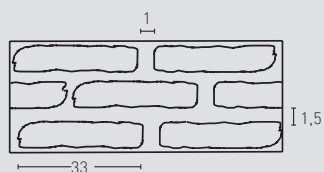
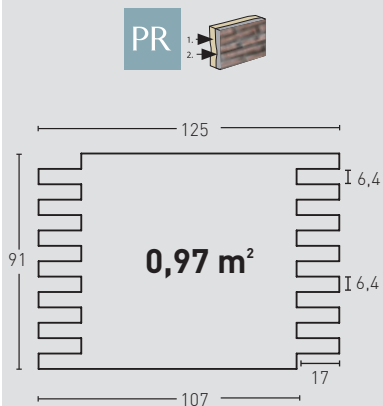

Las medidas pueden variar +/-1cm / Measurements may vary +/-1cm

PRODUCTO PRODUCT	COD.	DESCRIPCIÓN DESCRIPTION	KG			PR	€/unidad
PR	487	Panel Lad. Viejo Arcilloso Caleado	PR: 7-8 kg	PR: 4 un	PR: 48 un	-	-
	487-E	Ángulo Lad. Viejo Arcilloso Caleado	PR: 3 kg	PR: 2 un	PR: 30 un	-	-

Complementos necesarios para la instalación / Necessary materials for installation

Complementos necesarios para la instalación / Necessary materials for installation	Rendimiento Aprox. / Average Usage	Precio / Price
● MSA-50 Masilla Juntas Oscuro	1 Cartucho 2 - 3 Paneles	-
● PT-12 Pintura Junta Oscura	1 Bote 25 Paneles	-
○ PTE-21 Envejecido Marrón	1 Spray 15 Paneles	-

Complementos opcionales para la instalación / Optional materials for installation

Complementos opcionales para la instalación / Optional materials for installation	Rendimiento Aprox. / Average Usage	Precio / Price
○ MSA-3 Masilla de Pegado	1 Cartucho 4 - 5 Paneles	-
● PTX-34 Ladrillo Arcilloso	1 Spray 15 Paneles	-
● PTX-35 Ladrillo Arcilloso Oscuro	1 Spray 15 Paneles	-

PRODUCTO PRODUCT	COD.	DESCRIPCIÓN DESCRIPTION	KG			PR	€/unidad
PR	488	Panel Lad. Viejo Envejec. Caleado	PR: 7-8 kg	PR: 4 un	PR: 48 un	-	-
	488-E	Ángulo Lad. Viejo Envejec. Caleado	PR: 3 kg	PR: 2 un	PR: 30 un	-	-

Complementos necesarios para la instalación / Necessary materials for installation

Complementos necesarios para la instalación / Necessary materials for installation	Rendimiento Aprox. / Average Usage	Precio / Price
● MSA-50 Masilla Juntas Oscuro	1 Cartucho 2 - 3 Paneles	-
● PT-12 Pintura Junta Oscura	1 Bote 25 Paneles	-
● PTE-21 Pintura Envejecido Marrón	1 Spray 15 Paneles	-

Complementos opcionales para la instalación / Optional materials for installation

Complementos opcionales para la instalación / Optional materials for installation	Rendimiento Aprox. / Average Usage	Precio / Price
○ MSA-3 Masilla de Pegado	1 Cartucho 4 - 5 Paneles	-
● PTX-11 Pintura Rojo Viejo	1 Spray 8 Paneles	-

PRODUCTO PRODUCT	COD.	DESCRIPCIÓN DESCRIPTION	KG			PR	€/unidad
PR	489	Panel Ladrillo Viejo Junta Oscura	PR: 6-7 kg	PR: 4 un	PR: 48 un	-	-
	489-E	Ángulo Ladr. Viejo Junta Oscura	PR: 2-3 kg	PR: 4 un	PR: 60 un	-	-

Complementos necesarios para la instalación / Necessary materials for installation

Complementos necesarios para la instalación / Necessary materials for installation	Rendimiento Aprox. / Average Usage	Precio / Price
● MSA-50 Masilla Juntas Oscuro	1 Cartucho 2 - 3 Paneles	-
● PT-12 Pintura Junta Oscura	1 Bote 25 Paneles	-
○ PTE-33 Pintura Envejecido Caleado + Compó (Bote)	1 Spray 8 Paneles	-

Complementos opcionales para la instalación / Optional materials for installation

Complementos opcionales para la instalación / Optional materials for installation	Rendimiento Aprox. / Average Usage	Precio / Price
○ MSA-3 Masilla de Pegado	1 Cartucho 4 - 5 Paneles	-
● PTE-24 Pintura Envejecido Rojo	1 Spray 15 Paneles	-
● PTX-04 Beige Ladrillo	1 Spray 15 Paneles	-

Brick
LADRILLO
RÚSTICO

PANELPIEDRA®

PR

HD



PR 71 Blanco



PR 79 Terroso Caleado

Brick LADRILLO RÚSTICO

ACABADOS / FINISHES



03 Junta Oscura / Dark Grout



70 Envejecido / Aged



71 Blanco / White



72 Envejec. Caleado / Aged Whitewashed



73 Terroso / Earthy

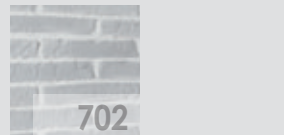

74 Arcilloso / Clay

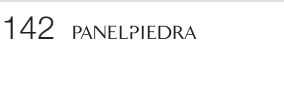

75 Arcilloso Caleado / Clay Whitewashed

76 Junta Osc.Caleado / Dark Grout Whitewashed

77 Terroso Caleado / Earthy Whitewashed

78 Gris Carbón / Carbon Grey

79 Gris Combinado / Two Tone Grey

MEDIDAS / MEASUREMENTS

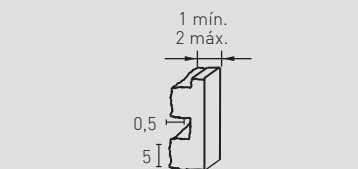
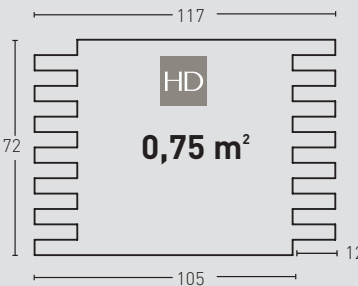
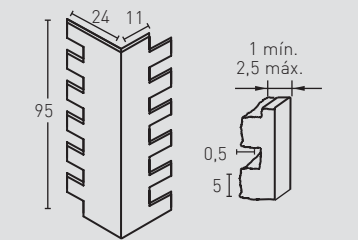
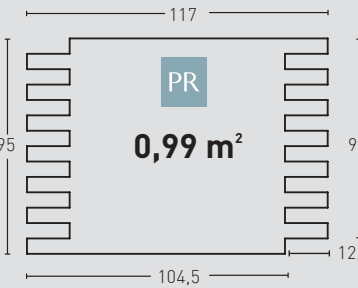

PRODUCTO / PRODUCT	COD.	DESCRIPCIÓN / DESCRIPTION	KG	PR	HD	PR	HD
PR	03	Panel Lad. Rústico Junta Oscura	PR:6-7kg / HD:15-20kg	PR:4un / HD:25un	PR:60un / HD:25un	-	-
HD	03-E	Ángulo Lad. Rústico Junta Oscura	PR: 3 kg / HD: --	PR:4un / HD: --	PR:30un / HD: --	-	-

Complementos necesarios para la instalación / Necessary materials for installation	Rendimiento Aprox. / Average Usage	Precio / Price
● MSA-50 Masilla Juntas Oscuro	1 Cartucho 2 - 3 Paneles	-
● PT-12 Pintura Junta Oscura	1 Bote 25 Paneles	-
● PTE-21 Pintura Envejecido Marrón	1 Spray 15 Paneles	-

Complementos opcionales para la instalación / Optional materials for installation	Rendimiento Aprox. / Average Usage	Precio / Price
○ MSA-3 Masilla de Pegado	1 Cartucho 4 - 5 Paneles	-
● PTE-24 Pintura Envejecido Rojo	1 Spray 15 Paneles	-
● PTX-04 Beige Ladrillo	1 Spray 15 Paneles	-

PRODUCTO / PRODUCT	COD.	DESCRIPCIÓN / DESCRIPTION	KG	PR	HD	PR	HD
PR	70	Panel Ladrillo Rústico Envejecido	PR:6-7kg / HD:15-20kg	PR:4un / HD:25un	PR:60un / HD:25un	-	-
HD	70-E	Ángulo Ladr. Rústico Envejecido	PR: 3 kg / HD: --	PR:4un / HD: --	PR:30un / HD: --	-	-

Complementos necesarios para la instalación / Necessary materials for installation	Rendimiento Aprox. / Average Usage	Precio / Price
● MSA-50 Masilla Juntas Oscuro	1 Cartucho 2 - 3 Paneles	-
● PT-12 Pintura Junta Oscura	1 Bote 8 Paneles	-
● PTE-21 Pintura Envejecido Marrón	1 Spray 15 Paneles	-

Complementos opcionales para la instalación / Optional materials for installation	Rendimiento Aprox. / Average Usage	Precio / Price
○ MSA-3 Masilla de Pegado	1 Cartucho 4 - 5 Paneles	-
● PTX-11 Pintura Rojo Viejo	1 Spray 15 Paneles	-

PRODUCTO / PRODUCT	COD.	DESCRIPCIÓN / DESCRIPTION	KG	PR	HD	PR	HD
PR	71	Panel Ladrillo Rústico Blanco	PR:6-7kg / HD:15-20kg	PR:4un / HD:25un	PR:60un / HD:25un	-	-
HD	71-E	Ángulo Ladrillo Rústico Blanco	PR: 3 kg / HD: --	PR:4un / HD: --	PR:30un / HD: --	-	-

Complementos necesarios para la instalación / Necessary materials for installation	Rendimiento Aprox. / Average Usage	Precio / Price
○ MSA-70 Masilla Juntas Blanco Italia	1 Cartucho 2 - 3 Paneles	-
○ PTX-10 Pintura Blanco Nieve	1 Spray 8 Paneles	-

Complementos opcionales para la instalación / Optional materials for installation	Rendimiento Aprox. / Average Usage	Precio / Price
○ MSA-3 Masilla de Pegado	1 Cartucho 4 - 5 Paneles	-

Las medidas pueden variar +/-1cm / Measurements may vary +/-1cm

Brick LADRILLO RÚSTICO

ACABADOS / FINISHES

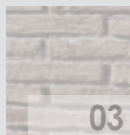

03
Junta Oscura /
Dark Grout



70
Envejecido /
Aged

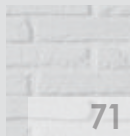

71
Blanco /
White



72
Envejec. Caleado /
Aged Whitewashed

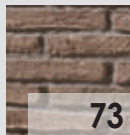

73
Terroso /
Earthy

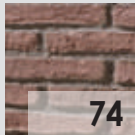

74
Arcilloso /
Clay



76
Arcilloso Caleado /
Clay Whitewashed

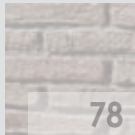

78
Junta Osc.Caleado /
Dark Grout Whitewashed

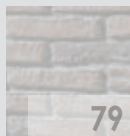

79
Terroso Caleado /
Earthy Whitewashed

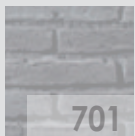

701
Gris Carbón /
Carbon Grey



702
Gris Combinado /
Two Tone Grey

MEDIDAS / MEASUREMENTS

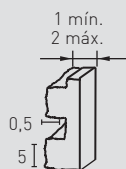
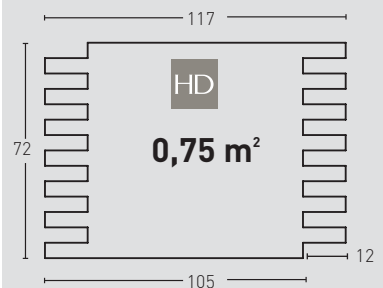
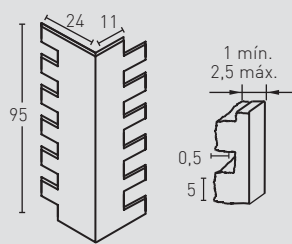
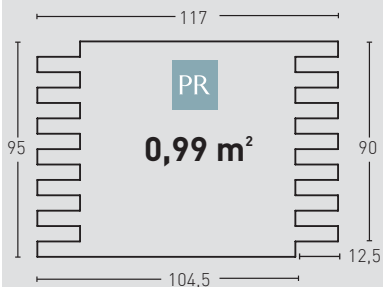

Las medidas pueden variar +/-1cm / Measurements may vary +/-1cm

PRODUCTO PRODUCT	COD.	DESCRIPCIÓN DESCRIPTION	KG			PR	HD
PR	HD	72 72-E Panel Lad. Rúst. Envej. Caleado Ángulo Lad. Rúst. Envej. Caleado	PR:6-7kg / HD:15-20kg PR: 3 kg / HD: --	PR:4un / HD:25un PR:4un / HD: --	PR:60un / HD:25un PR:30un / HD: --	-	-

Complementos necesarios para la instalación / Necessary materials for installation			Rendimiento Aprox. / Average Usage		Precio / Price	
		● MSA-50 Masilla Juntas Oscuro	1 Cartucho 2 - 3 Paneles	-	-	-
		● PT-12 Pintura Junta Oscura	1 Bote 25 Paneles	-	-	-
		○ PTE-33 Pintura Envejecido Caleado + Comp6 (Bote)	1 Spray 8 Paneles	-	-	-

Complementos opcionales para la instalación / Optional materials for installation			Rendimiento Aprox. / Average Usage		Precio / Price	
		○ MSA-3 Masilla de Pegado	1 Cartucho 4 - 5 Paneles	-	-	-
		● PTX-11 Pintura Rojo Viejo	1 Spray 15 Paneles	-	-	-

PRODUCTO PRODUCT	COD.	DESCRIPCIÓN DESCRIPTION	KG			PR	HD
PR	HD	73 73-E Panel Ladrillo Rústico Terroso Ángulo Ladrillo Rústico Terroso	PR:6-7kg / HD:15-20kg PR: 3 kg / HD: --	PR:4un / HD:25un PR:4un / HD: --	PR:60un / HD:25un PR:30un / HD: --	-	-

Complementos necesarios para la instalación / Necessary materials for installation			Rendimiento Aprox. / Average Usage		Precio / Price	
		● MSA-50 Masilla Juntas Oscuro	1 Cartucho 2 - 3 Paneles	-	-	-
		● PT-12 Pintura Junta Oscura	1 Bote 25 Paneles	-	-	-
		● PTE-21 Pintura Envejecido Marrón	1 Spray 15 Paneles	-	-	-

Complementos opcionales para la instalación / Optional materials for installation			Rendimiento Aprox. / Average Usage		Precio / Price	
		○ MSA-3 Masilla de Pegado	1 Cartucho 7 Paneles	-	-	-
		● PTX-32 Ladrillo Terroso	1 Spray 15 Paneles	-	-	-
		● PTX-33 Ladrillo Terroso Oscuro	1 Spray 15 Paneles	-	-	-

PRODUCTO PRODUCT	COD.	DESCRIPCIÓN DESCRIPTION	KG			PR	HD
PR	HD	74 74-E Panel Ladrillo Rústico Arcilloso Ángulo Ladrillo Rústico Arcilloso	PR:6-7kg / HD:15-20kg PR: 3 kg / HD: --	PR:4un / HD:25un PR:4un / HD: --	PR:60un / HD:25un PR:30un / HD: --	-	-

Complementos necesarios para la instalación / Necessary materials for installation			Rendimiento Aprox. / Average Usage		Precio / Price	
		● MSA-50 Masilla Juntas Oscuro	1 Cartucho 2 - 3 Paneles	-	-	-
		● PT-12 Pintura Junta Oscura	1 Bote 25 Paneles	-	-	-
		● PTE-21 Pintura Envejecido Marrón	1 Spray 15 Paneles	-	-	-

Complementos opcionales para la instalación / Optional materials for installation			Rendimiento Aprox. / Average Usage		Precio / Price	
		○ MSA-3 Masilla de Pegado	1 Cartucho 4 - 5 Paneles	-	-	-
		● PTX-34 Ladrillo Arcilloso	1 Spray 15 Paneles	-	-	-
		● PTX-35 Ladrillo Arcilloso Oscuro	1 Spray 15 Paneles	-	-	-

Brick LADRILLO RÚSTICO

ACABADOS / FINISHES



03 Junta Oscura / Dark Grout



70 Envejecido / Aged

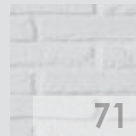

71 Blanco / White

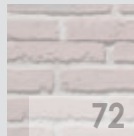

72 Envejec. Caleado / Aged Whitewashed

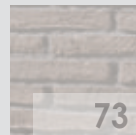

73 Terroso / Earthy



74 Arcilloso / Clay



76 Arcilloso Caleado / Clay Whitewashed

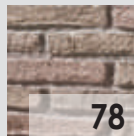

78 Junta Osc.Caleado / Dark Grout Whitewashed



79 Terroso Caleado / Earthy Whitewashed

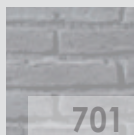

701 Gris Carbón / Carbon Grey

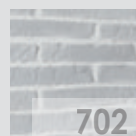

702 Gris Combinado / Two Tone Grey

MEDIDAS / MEASUREMENTS

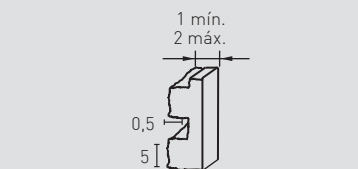
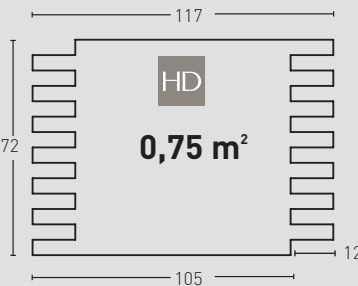
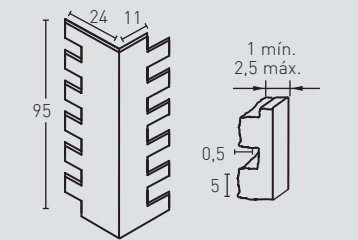
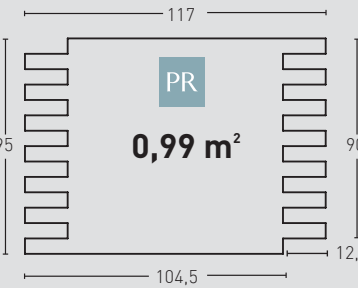

Las medidas pueden variar +/-1cm / Measurements may vary +/-1cm

PRODUCTO / PRODUCT	COD.	DESCRIPCIÓN / DESCRIPTION	KG	PR	HD	PR	HD
PR	76	Panel Lad. Rúst. Arcilloso Caleado	PR:6-7kg / HD:15-20kg	PR:4un / HD:25un	PR:60un / HD:25un	€/unidad	-
HD	76-E	Ángulo Lad. Rúst. Arcilloso Caleado	PR: 3 kg / HD: --	PR:4un / HD: --	PR:30un / HD: --	-	-

Complementos necesarios para la instalación / Necessary materials for installation

Complementos necesarios para la instalación / Necessary materials for installation	Rendimiento Aprox. / Average Usage	Precio / Price
● MSA-50 Masilla Juntas Oscuro	1 Cartucho 2 - 3 Paneles	-
● PT-12 Pintura Junta Oscura	1 Bote 25 Paneles	-
○ PTE-33 Pintura Envejecido Caleado + Comp6 (Bote)	1 Spray 8 Paneles	-

Complementos opcionales para la instalación / Optional materials for installation

Complementos opcionales para la instalación / Optional materials for installation	Rendimiento Aprox. / Average Usage	Precio / Price
○ MSA-3 Masilla de Pegado	1 Cartucho 4 - 5 Paneles	-
● PTX-34 Ladrillo Arcilloso	1 Spray 15 Paneles	-
● PTX-35 Ladrillo Arcilloso Oscuro	1 Spray 15 Paneles	-

PRODUCTO / PRODUCT	COD.	DESCRIPCIÓN / DESCRIPTION	KG	PR	HD	PR	HD
PR	78	Panel Ladrillo Rústico J. Oscura	PR:6-7kg / HD:15-20kg	PR:4un / HD:25un	PR:60un / HD:25un	€/unidad	-
HD	78-E	Ángulo Ladr. Rústico J. Oscura	PR: 3 kg / HD: --	PR:4un / HD: --	PR:30un / HD: --	-	-

Complementos necesarios para la instalación / Necessary materials for installation

Complementos necesarios para la instalación / Necessary materials for installation	Rendimiento Aprox. / Average Usage	Precio / Price
● MSA-50 Masilla Juntas Oscuro	1 Cartucho 2 - 3 Paneles	-
● PT-12 Pintura Junta Oscura	1 Bote 25 Paneles	-
○ PTE-33 Pintura Envejecido Caleado + Comp6 (Bote)	1 Spray 8 Paneles	-

Complementos opcionales para la instalación / Optional materials for installation

Complementos opcionales para la instalación / Optional materials for installation	Rendimiento Aprox. / Average Usage	Precio / Price
○ MSA-3 Masilla de Pegado	1 Cartucho 4 - 5 Paneles	-
● PTE-24 Pintura Envejecido Rojo	1 Spray 15 Paneles	-
● PTX-04 Beige Ladrillo	1 Spray 15 Paneles	-

PRODUCTO / PRODUCT	COD.	DESCRIPCIÓN / DESCRIPTION	KG	PR	HD	PR	HD
PR	79	Panel Lad. Rúst. Terroso Caleado	PR:6-7kg / HD:15-20kg	PR:4un / HD:25un	PR:60un / HD:25un	€/unidad	-
HD	79-E	Ángulo Lad. Rúst. terroso Caleado	PR: 3 kg / HD: --	PR:4un / HD: --	PR:30un / HD: --	-	-

Complementos necesarios para la instalación / Necessary materials for installation

Complementos necesarios para la instalación / Necessary materials for installation	Rendimiento Aprox. / Average Usage	Precio / Price
● MSA-50 Masilla Juntas Oscuro	1 Cartucho 2 - 3 Paneles	-
● PT-12 Pintura Junta Oscura	1 Bote 25 Paneles	-
○ PTE-33 Pintura Envejecido Caleado + Comp6 (Bote)	1 Spray 8 Paneles	-

Complementos opcionales para la instalación / Optional materials for installation

Complementos opcionales para la instalación / Optional materials for installation	Rendimiento Aprox. / Average Usage	Precio / Price
○ MSA-3 Masilla de Pegado	1 Cartucho 4 - 5 Paneles	-
● PTX-32 Ladrillo Terroso	1 Spray 15 Paneles	-
● PTX-21 Pintura Envejecido Marrón	1 Spray 15 Paneles	-

Brick LADRILLO RÚSTICO

ACABADOS / FINISHES

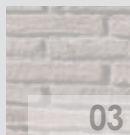

03 Junta Oscura / Dark Grout



70 Envejecido / Aged

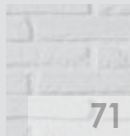

71 Blanco / White



72 Envejec. Caleado / Aged Whitewashed

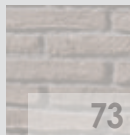

73 Terroso / Earthy



74 Arcilloso / Clay



76 Arcilloso Caleado / Clay Whitewashed

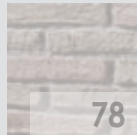

78 Junta Osc.Caleado / Dark Grout Whitewashed

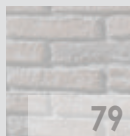

79 Terroso Caleado / Earthy Whitewashed

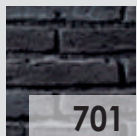

701 Gris Carbón / Carbon Grey

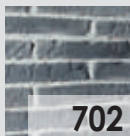

702 Gris Combinado / Two Tone Grey

MEDIDAS / MEASUREMENTS

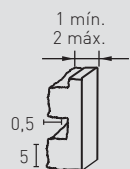
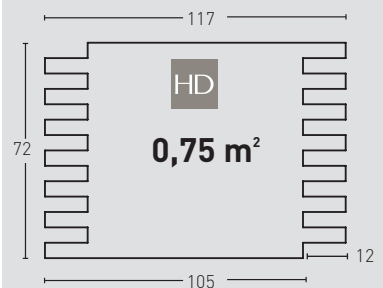
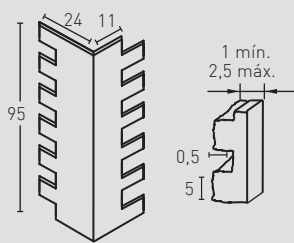
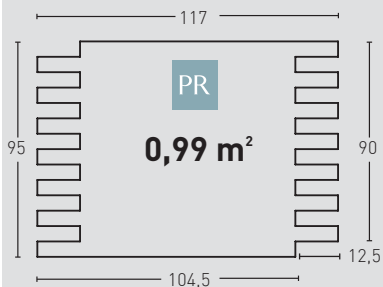

PRODUCTO / PRODUCT	COD.	DESCRIPCIÓN / DESCRIPTION	KG	KG	KG	PR	HD
PR	HD	701 Panel Lad. Rústico Gris Carbón	PR:6-7kg / HD:15-20kg	PR:4un / HD:25un	PR:60un / HD:25un	-	-
		701-E Ángulo Lad. Rústico Gris Carbón	PR: 3 kg / HD: --	PR:4un / HD: --	PR:30un / HD: --	-	-

Complementos necesarios para la instalación / Necessary materials for installation			Rendimiento Aprox. / Average Usage		Precio / Price	
	● MSA-30 Masilla Juntas Gris		1 Cartucho 2 Paneles	-		
	● PT-68 Pintura Junta Ladrillo Antracita		1 Spray 8 Paneles	-		
	● PT-91 Pintura Gris Carbón		1 Spray 15 Paneles	-		

Complementos opcionales para la instalación / Optional materials for installation			Rendimiento Aprox. / Average Usage		Precio / Price	
	○ MSA-3 Masilla de Pegado		1 Cartucho 4 Paneles	-		

PRODUCTO / PRODUCT	COD.	DESCRIPCIÓN / DESCRIPTION	KG	KG	KG	PR	HD
PR	HD	702 Panel Lad. Rústico Gris Combin.	PR:6-7kg / HD:15-20kg	PR:4un / HD:25un	PR:60un / HD:25un	-	-
		702-E Ángulo Lad. Rústico Gris Combin.	PR: 3 kg / HD: --	PR:4un / HD: --	PR:30un / HD: --	-	-

Complementos necesarios para la instalación / Necessary materials for installation			Rendimiento Aprox. / Average Usage		Precio / Price	
	● MSA-10 Masilla Juntas Beige		1 Cartucho 2 Paneles	-		
	● PT-69 Pintura Junta Ladrillo Gris Combinado		1 Spray 8 Paneles	-		
	● PTX-92 Pintura Ladrillo Gris Combinado		1 Spray 15 Paneles	-		

Complementos opcionales para la instalación / Optional materials for installation			Rendimiento Aprox. / Average Usage		Precio / Price	
	○ MSA-3 Masilla de Pegado		1 Cartucho 4 Paneles	-		

Las medidas pueden variar +/-1cm / Measurements may vary +/-1cm

BRICK

Brick LADRILLO ADOBE

PANELPIEDRA®

PR



PR 562 Blanco



PR 561 Envejecido

Brick LADRILLO ADOBE

ACABADOS / FINISHES



560
Junta Oscura /
Dark Grout



561
Envejecido /
Aged

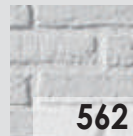

562
Blanco /
White

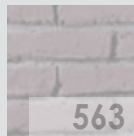

563
Envejec. Caleado /
Aged Whitewashed



564
Terroso /
Earthy



565
Arcilloso /
Clay



566
Arcilloso Caleado /
Clay Whitewashed

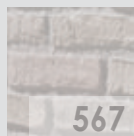

567
Junta Osc. Caleado /
Dark Grout Whitewashed



568
Terroso Caleado /
Earthy Whitewashed

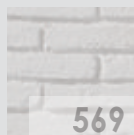

569
Blanco Antiguo /
Old White

MEDIDAS / MEASUREMENTS

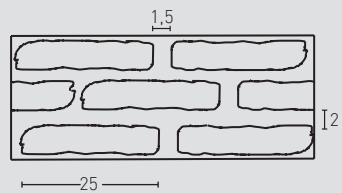
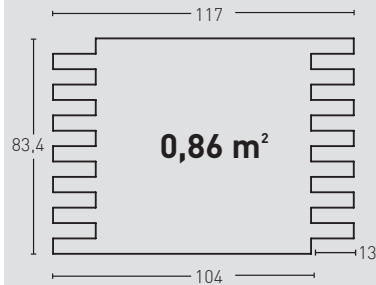
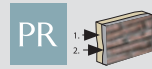

Las medidas pueden variar +/-1cm / Measurements may vary +/-1cm

PRODUCTO PRODUCT	COD.	DESCRIPCIÓN DESCRIPTION	KG			PR
PR	560	Panel Ladrillo Adobe Junta Oscura	PR: 7-8 kg	PR: 4 un	PR: 48 un	-

Complementos necesarios para la instalación / Necessary materials for installation **Rendimiento Aprox. / Average Usage** **Precio / Price**

● MSA-50 Masilla Juntas Oscuro	1 Cartucho 2 - 3 Paneles	-
● PT-12 Pintura Junta Oscura	1 Bote 25 Paneles	-
● PTE-21 Pintura Envejecido Marrón	1 Spray 15 Paneles	-

Complementos opcionales para la instalación / Optional materials for installation **Rendimiento Aprox. / Average Usage** **Precio / Price**

○ MSA-3 Masilla de Pegado	1 Cartucho 4 - 5 Paneles	-
● PTE-24 Pintura Envejecido Rojo	1 Spray 15 Paneles	-
● PTX-04 Beige Ladrillo	1 Spray 15 Paneles	-

PRODUCTO PRODUCT	COD.	DESCRIPCIÓN DESCRIPTION	KG			PR
PR	561	Panel Ladrillo Adobe Envejecido	PR: 7-8 kg	PR: 4 un	PR: 48 un	-

Complementos necesarios para la instalación / Necessary materials for installation **Rendimiento Aprox. / Average Usage** **Precio / Price**

● MSA-50 Masilla Juntas Oscuro	1 Cartucho 2 - 3 Paneles	-
● PT-12 Pintura Junta Oscura	1 Bote 25 Paneles	-
● PTX-501 Pintura Rojo Oscuro	1 Spray 15 Paneles	-
● Comp-09 Esparto Rojo	1 Pliego 20 Paneles	-

Complementos opcionales para la instalación / Optional materials for installation **Rendimiento Aprox. / Average Usage** **Precio / Price**

○ MSA-3 Masilla de Pegado	1 Cartucho 4 - 5 Paneles	-
● PTX-11 Pintura Rojo Viejo	1 Spray 15 Paneles	-
● PTX-500 Pintura Rojo Claro	1 Spray 15 Paneles	-
● PTX-19 Pintura Antracita	1 Spray 15 Paneles	-

PRODUCTO PRODUCT	COD.	DESCRIPCIÓN DESCRIPTION	KG			PR
PR	562	Panel Ladrillo Adobe Blanco	PR: 7-8 kg	PR: 4 un	PR: 48 un	-

Complementos necesarios para la instalación / Necessary materials for installation **Rendimiento Aprox. / Average Usage** **Precio / Price**

○ MSA-70 Masilla Juntas Blanco Italia	1 Cartucho 2 - 3 Paneles	-
○ PTX-10 Pintura Blanco Nieve	1 Spray 8 Paneles	-

Complementos opcionales para la instalación / Optional materials for installation **Rendimiento Aprox. / Average Usage** **Precio / Price**

○ MSA-3 Masilla de Pegado	1 Cartucho 4 - 5 Paneles	-
---------------------------	--------------------------	---

Brick LADRILLO ADOBE

ACABADOS / FINISHES

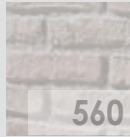

560
Junta Oscura /
Dark Grout



561
Envejecido /
Aged

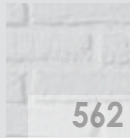

562
Blanco /
White



563
Envejec. Caleado /
Aged Whitewashed

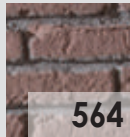

564
Terroso /
Earthy

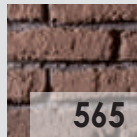

565
Arcilloso /
Clay



566
Arcilloso Caleado /
Clay Whitewashed

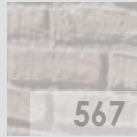

567
Junta Osc. Caleado /
Dark Grout Whitewashed



568
Terroso Caleado /
Earthy Whitewashed



569
Blanco Antiguo /
Old White

MEDIDAS / MEASUREMENTS

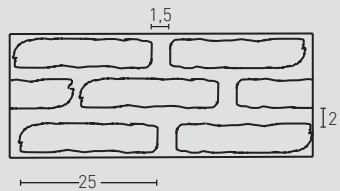
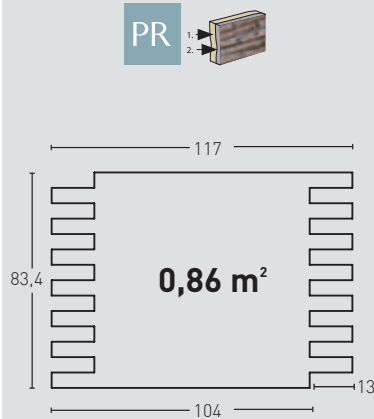

Las medidas pueden variar +/- 1cm / Measurements may vary +/- 1cm

PRODUCTO PRODUCT	COD.	DESCRIPCIÓN DESCRIPTION	KG			PR	€/unidad
PR	563	Panel Ladrillo Adobe Junta Oscura	PR: 7-8 kg	PR: 4 un	PR: 48 un	-	-

Complementos necesarios para la instalación / Necessary materials for installation			Rendimiento Aprox. / Average Usage		Precio / Price	
	● MSA-50 Masilla Juntas Oscuro		1 Cartucho 2 - 3 Paneles	-		
	● PT-12 Pintura Junta Oscura		1 Bote 25 Paneles	-		
	○ PTE-33 Pintura Envejecido Caleado + Comp6 (Bote)		1 Spray 8 Paneles	-		

Complementos opcionales para la instalación / Optional materials for installation			Rendimiento Aprox. / Average Usage		Precio / Price	
	○ MSA-3 Masilla de Pegado		1 Cartucho 4 - 5 Paneles	-		
	● PTX-11 Pintura Rojo Viejo		1 Spray 15 Paneles	-		

PRODUCTO PRODUCT	COD.	DESCRIPCIÓN DESCRIPTION	KG			PR	€/unidad
PR	564	Panel Ladrillo Adobe Terroso	PR: 7-8 kg	PR: 4 un	PR: 48 un	-	-

Complementos necesarios para la instalación / Necessary materials for installation			Rendimiento Aprox. / Average Usage		Precio / Price	
	● MSA-50 Masilla Juntas Oscuro		1 Cartucho 2 - 3 Paneles	-		
	● PT-12 Pintura Junta Oscura		1 Bote 25 Paneles	-		
	● PTE-21 Pintura Envejecido Marrón		1 Spray 15 Paneles	-		

Complementos opcionales para la instalación / Optional materials for installation			Rendimiento Aprox. / Average Usage		Precio / Price	
	○ MSA-3 Masilla de Pegado		1 Cartucho 4 - 5 Paneles	-		
	● PTX-32 Ladrillo Terroso		1 Spray 15 Paneles	-		
	● PTX-33 Ladrillo Terroso Oscuro		1 Spray 15 Paneles	-		

PRODUCTO PRODUCT	COD.	DESCRIPCIÓN DESCRIPTION	KG			PR	€/unidad
PR	565	Panel Ladrillo Adobe Arcilloso	PR: 7-8 kg	PR: 4 un	PR: 48 un	-	-

Complementos necesarios para la instalación / Necessary materials for installation			Rendimiento Aprox. / Average Usage		Precio / Price	
	● MSA-50 Masilla Juntas Oscuro		1 Cartucho 2 - 3 Paneles	-		
	● PT-12 Pintura Junta Oscura		1 Bote 25 Paneles	-		
	● PTE-21 Pintura Envejecido Marrón		1 Spray 15 Paneles	-		

Complementos opcionales para la instalación / Optional materials for installation			Rendimiento Aprox. / Average Usage		Precio / Price	
	○ MSA-3 Masilla de Pegado		1 Cartucho 4 - 5 Paneles	-		
	● PTX-34 Ladrillo Arcilloso		1 Spray 15 Paneles	-		
	● PTX-35 Ladrillo Arcilloso Oscuro		1 Spray 15 Paneles	-		

Brick LADRILLO ADOBE

ACABADOS / FINISHES



560 Junta Oscura / Dark Grout



561 Envejecido / Aged



562 Blanco / White

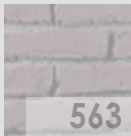

563 Envejec. Caleado / Aged Whitewashed



564 Terroso / Earthy

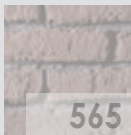

565 Arcilloso / Clay



566 Arcilloso Caleado / Clay Whitewashed

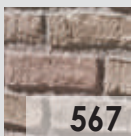

567 Junta Osc. Caleado / Dark Grout Whitewashed



568 Terroso Caleado / Earthy Whitewashed

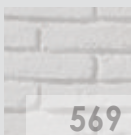

569 Blanco Antiguo / Old White

MEDIDAS / MEASUREMENTS

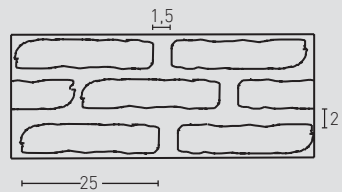
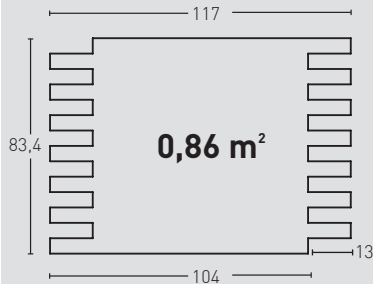
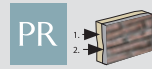

Las medidas pueden variar +/-1cm / Measurements may vary +/-1cm

PRODUCTO / PRODUCT	COD.	DESCRIPCIÓN / DESCRIPTION	KG			PR
PR	566	Panel Ladrillo Adobe Arcilloso Caleado	PR: 7-8 kg	PR: 4 un	PR: 48 un	-

Complementos necesarios para la instalación / Necessary materials for installation **Rendimiento Aprox. / Average Usage** **Precio / Price**

MSA-50 Masilla Juntas Oscuro	1 Cartucho 2 - 3 Paneles	-
PT-12 Pintura Junta Oscuro	1 Bote 25 Paneles	-
PTE-33 Pintura Envejecido Caleado + Comp6 (Bote)	1 Spray 8 Paneles	-

Complementos opcionales para la instalación / Optional materials for installation **Rendimiento Aprox. / Average Usage** **Precio / Price**

MSA-3 Masilla de Pegado	1 Cartucho 4 - 5 Paneles	-
PTX-34 Ladrillo Arcilloso	1 Spray 15 Paneles	-
PTX-35 Ladrillo Arcilloso Oscuro	1 Spray 15 Paneles	-

PRODUCTO / PRODUCT	COD.	DESCRIPCIÓN / DESCRIPTION	KG			PR
PR	567	Panel Ladrillo Adobe Junta Oscura Caleado	PR: 7-8 kg	PR: 4 un	PR: 48 un	-

Complementos necesarios para la instalación / Necessary materials for installation **Rendimiento Aprox. / Average Usage** **Precio / Price**

MSA-50 Masilla Juntas Oscuro	1 Cartucho 2 - 3 Paneles	-
PT-12 Pintura Junta Oscuro	1 Bote 25 Paneles	-
PTE-33 Pintura Envejecido Caleado + Comp6 (Bote)	1 Spray 15 Paneles	-

Complementos opcionales para la instalación / Optional materials for installation **Rendimiento Aprox. / Average Usage** **Precio / Price**

MSA-3 Masilla de Pegado	1 Cartucho 4 - 5 Paneles	-
PTE-24 Pintura Envejecido Rojo	1 Spray 15 Paneles	-
PTX-04 Beige Ladrillo	1 Spray 15 Paneles	-

PRODUCTO / PRODUCT	COD.	DESCRIPCIÓN / DESCRIPTION	KG			PR
PR	568	Panel Ladrillo Adobe Terroso Caleado	PR: 7-8 kg	PR: 4 un	PR: 48 un	-

Complementos necesarios para la instalación / Necessary materials for installation **Rendimiento Aprox. / Average Usage** **Precio / Price**

MSA-50 Masilla Juntas Oscuro	1 Cartucho 2 - 3 Paneles	-
PT-12 Pintura Junta Oscuro	1 Bote 25 Paneles	-
PTE-33 Pintura Envejecido Caleado + Comp6 (Bote)	1 Spray 10 Paneles	-

Complementos opcionales para la instalación / Optional materials for installation **Rendimiento Aprox. / Average Usage** **Precio / Price**

MSA-3 Masilla de Pegado	1 Cartucho 4 - 5 Paneles	-
PTX-32 Ladrillo Terroso	1 Spray 15 Paneles	-
PTE-21 Pintura Envejecido Marrón	1 Spray 15 Paneles	-

Brick LADRILLO ADOBE

ACABADOS / FINISHES

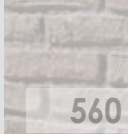

560
Junta Oscura /
Dark Grout



561
Envejecido /
Aged

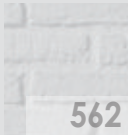

562
Blanco /
White

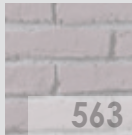

563
Envejec. Caleado /
Aged Whitewashed

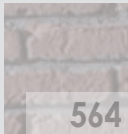

564
Terroso /
Earthy

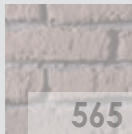

565
Arcilloso /
Clay



566
Arcilloso Caleado /
Clay Whitewashed

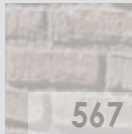

567
Junta Osc.Caleado /
Dark Grout Whitewashed



568
Terroso Caleado /
Earthy Whitewashed



569
Blanco Antiguo /
Old White

MEDIDAS / MEASUREMENTS

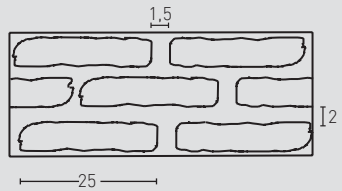
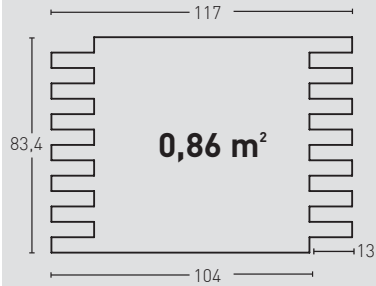

Las medidas pueden variar +/- 1cm / Measurements may vary +/- 1cm

PRODUCTO PRODUCT	COD.	DESCRIPCIÓN DESCRIPTION	KG			PR	€/unidad
PR	569	Panel Ladrillo Adobe Blanco Antiguo	PR: 7-8 kg	PR: 4 un	PR: 48 un	-	-
Complementos necesarios para la instalación / Necessary materials for installation				Rendimiento Aprox. / Average Usage		Precio / Price	
		<input type="checkbox"/> MSA-70 Masilla Blanco Italia		1 Cartucho 2 - 3 Paneles		-	
		<input type="checkbox"/> PTX-20 Pintura Blanco Italia		1 Bote 8 Paneles		-	
		<input checked="" type="checkbox"/> PTX-51 Pintura Blanco Azulado		1 Spray 8 Paneles		-	
Complementos opcionales para la instalación / Optional materials for installation				Rendimiento Aprox. / Average Usage		Precio / Price	
		<input type="checkbox"/> MSA-3 Masilla de Pegado		1 Cartucho 4 - 5 Paneles		-	
		<input type="checkbox"/> PTE-21 Pintura Envejecido Marrón		1 Spray 8 Paneles		-	
		<input type="checkbox"/> PTE-24 Pintura Envejecido Rojo		1 Spray 15 Paneles		-	

BRICK

Brick
LADRILLO
CARAVISTA

PANELPIEDRA®

PR

HD

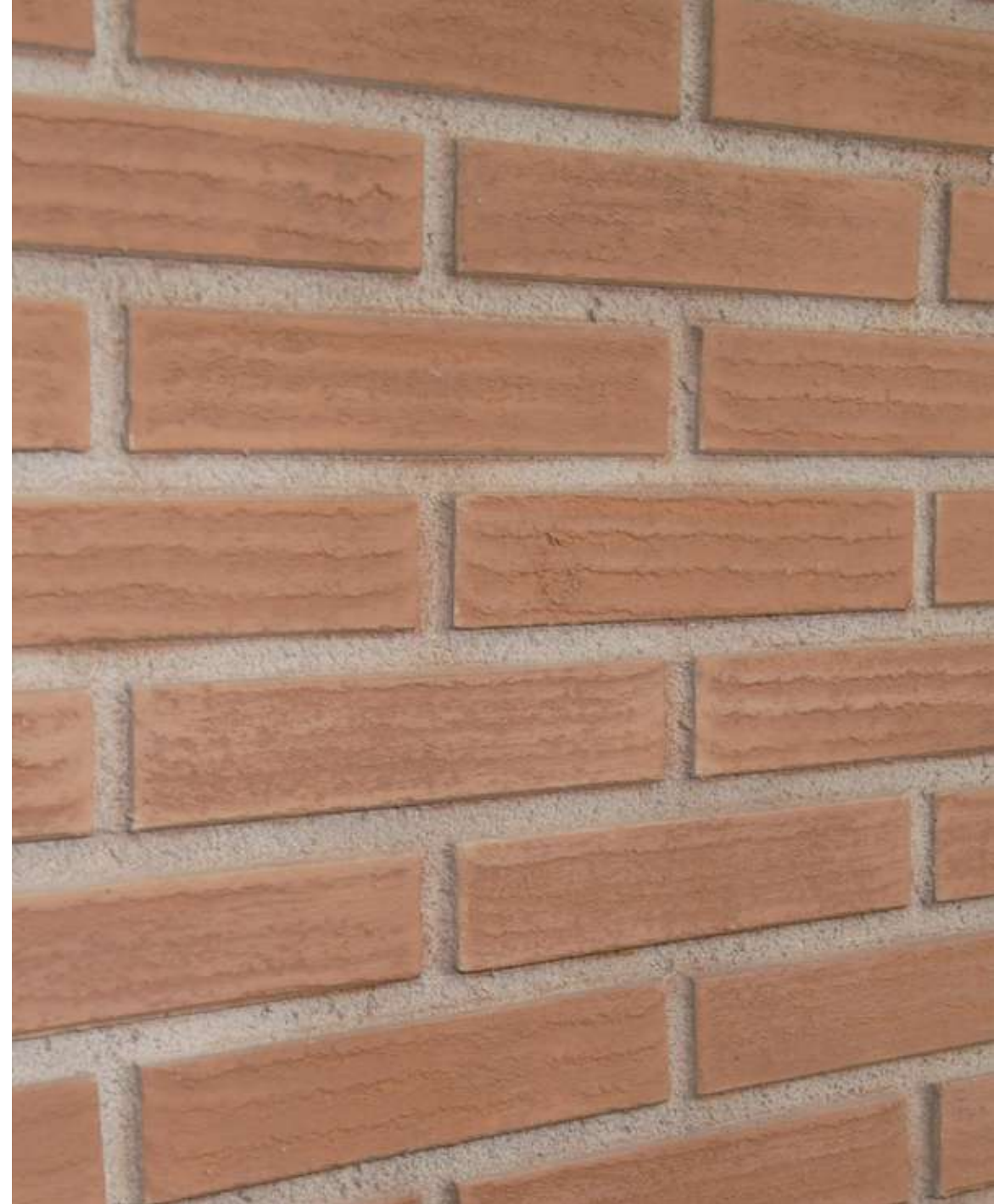

PR 05 Marrón



PR 77 Blanco



Brick LADRILLO CARAVISTA

ACABADOS / FINISHES



77

Blanco /
White

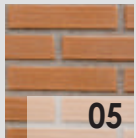

05

Marrón /
Brown

MEDIDAS / MEASUREMENTS

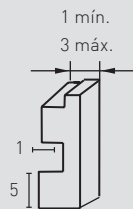
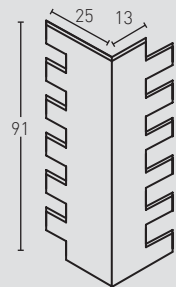
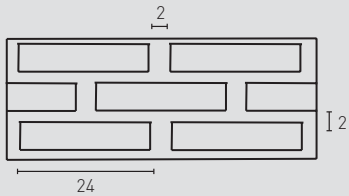
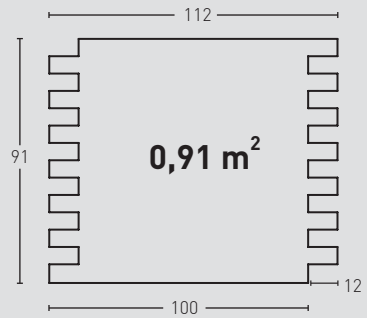

Las medidas pueden variar +/-1cm / Measurements may vary +/-1cm

PRODUCTO PRODUCT	COD.	DESCRIPCIÓN DESCRIPTION	KG			PR	HD
PR HD	77 77-E	Panel Ladrillo Caravista Blanco Ángulo Ladrillo Caravista Blanco	PR:6-7kg / HD:15-20kg PR: 3 kg / HD: --	PR:5un / HD:25un PR:4un / HD: --	PR:48un / HD:25un PR:60un / HD: --	-	-
Complementos necesarios para la instalación / Necessary materials for installation			Rendimiento Aprox. / Average Usage		Precio / Price		
	<input type="checkbox"/>	MSA-70 Masilla Juntas Blanco Italia	1 Cartucho 2 Paneles		-		
	<input type="checkbox"/>	PTX-10 Pintura Blanco Nieve	1 Spray 8 Paneles		-		
Complementos opcionales para la instalación / Optional materials for installation			Rendimiento Aprox. / Average Usage		Precio / Price		
	<input type="checkbox"/>	MSA-3 Masilla de Pegado	1 Cartucho 4 - 5 Paneles		-		

PRODUCTO PRODUCT	COD.	DESCRIPCIÓN DESCRIPTION	KG			PR	HD
PR HD	05 05-E	Panel Ladrillo Caravista Marrón Ángulo Ladrillo Caravista Marrón	PR:6-7kg / HD:15-20kg PR: 3 kg / HD: --	PR:5un / HD:25un PR:4un / HD: --	PR:48un / HD:25un PR:60un / HD: --	-	-
Complementos necesarios para la instalación / Necessary materials for installation			Rendimiento Aprox. / Average Usage		Precio / Price		
	<input checked="" type="checkbox"/>	MSA-50 Masilla Juntas Oscuro	1 Cartucho 2 Paneles		-		
	<input checked="" type="checkbox"/>	PT-12 Pintura Junta Oscuro	1 Bote 8 Paneles		-		
	<input checked="" type="checkbox"/>	PTE-21 Pintura Envejecido Marrón	1 Spray 15 Paneles		-		
Complementos opcionales para la instalación / Optional materials for installation			Rendimiento Aprox. / Average Usage		Precio / Price		
	<input type="checkbox"/>	MSA-3 Masilla de Pegado	1 Cartucho 4 - 5 Paneles		-		
	<input checked="" type="checkbox"/>	PTX-06 Pintura Rojo	1 Spray 15 Paneles		-		

Brick
LADRILLO
LOFT

PANELPIEDRA®

PR



PR 532 Blanco Antiguo



PR 533 Marrón



Brick LADRILLO LOFT

ACABADOS / FINISHES



530
Envejecido /
Aged

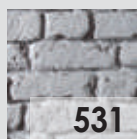

531
Blanco /
White

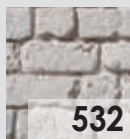

532
Blanco Antiguo /
Old White

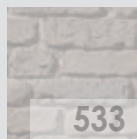

533
Marrón /
Brown

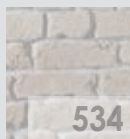

534
Marrón Tierra /
Earthy Brown

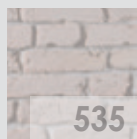

535
Natural /
Natural

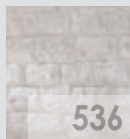

536
Industrial /
Industrial



537
Gris Carbón /
Carbon Grey



538
Gris Combinado /
Two Tone Grey

MEDIDAS / MEASUREMENTS

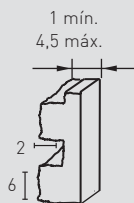
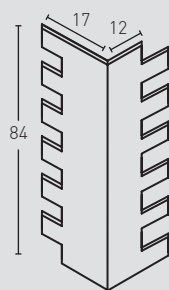
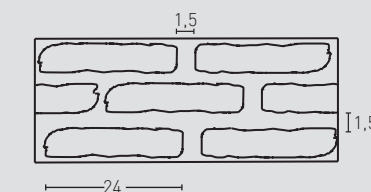
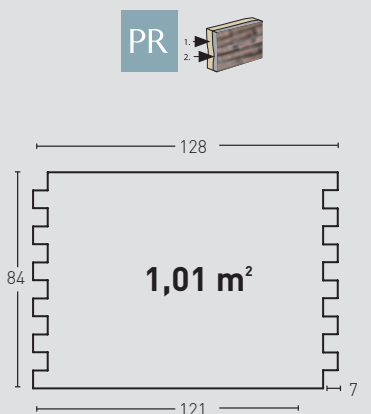

Las medidas pueden variar +/- 1cm / Measurements may vary +/- 1cm

PRODUCTO / PRODUCT	COD.	DESCRIPCIÓN / DESCRIPTION	KG	BRICK	PR	PR
PR	530 530-E	Panel Ladrillo Loft Envejecido	PR: 8-9 kg	PR: 3 un	PR: 36 un	€/unidad -
		Ángulo Ladrillo Loft Envejecido	PR: 4-5 kg	PR: 6 un	PR: 30 un	-

Complementos necesarios para la instalación / Necessary materials for installation **Rendimiento Aprox. / Average Usage** **Precio / Price**

	● MSA-50 Masilla Juntas Oscuro	1 Cartucho 2 Paneles	-
	● PT-12 Pintura Junta Oscura	1 Bote 25 Paneles	-
	● PTX-501 Pintura Rojo Oscuro	1 Spray 15 Paneles	-
	● Comp-09 Esparto Rojo	1 Pliego 20 Paneles	-

Complementos opcionales para la instalación / Optional materials for installation **Rendimiento Aprox. / Average Usage** **Precio / Price**

	○ MSA-3 Masilla de Pegado	1 Cartucho 4 - 5 Paneles	-
	● PTX-11 Pintura Rojo Viejo	1 Spray 15 Paneles	-
	● PTX-500 Pintura Rojo Claro	1 Spray 15 Paneles	-
	● PTX-19 Pintura Antracita	1 Spray 15 Paneles	-

PRODUCTO / PRODUCT	COD.	DESCRIPCIÓN / DESCRIPTION	KG	BRICK	PR	PR
PR	531 531-E	Panel Ladrillo Loft Blanco	PR: 8-9 kg	PR: 3 un	PR: 36 un	€/unidad -
		Ángulo Ladrillo Loft Blanco	PR: 4-5 kg	PR: 6 un	PR: 30 un	-

Complementos necesarios para la instalación / Necessary materials for installation **Rendimiento Aprox. / Average Usage** **Precio / Price**

	○ MSA-70 Masilla Juntas Blanco Italia	1 Cartucho 2 Paneles	-
	○ PTX-10 Pintura Blanco Nieve	1 Spray 8 Paneles	-

Complementos opcionales para la instalación / Optional materials for installation **Rendimiento Aprox. / Average Usage** **Precio / Price**

	○ MSA-3 Masilla de Pegado	1 Cartucho 4 - 5 Paneles	-
--	---------------------------	--------------------------	---

PRODUCTO / PRODUCT	COD.	DESCRIPCIÓN / DESCRIPTION	KG	BRICK	PR	PR
PR	532 532-E	Panel Ladr. Loft Blanco Antiguo	PR: 8-9 kg	PR: 3 un	PR: 36 un	€/unidad -
		Ángulo Ladr. Loft Blanco Antiguo	PR: 4-5 kg	PR: 6 un	PR: 30 un	-

Complementos necesarios para la instalación / Necessary materials for installation **Rendimiento Aprox. / Average Usage** **Precio / Price**

	○ MSA-70 Masilla Blanco Italia	1 Cartucho 2 Paneles	-
	○ PTX-20 Pintura Blanco Italia	1 Spray 8 Paneles	-
	● PTX-51 Pintura Blanco Azulado	1 Spray 8 Paneles	-

Complementos opcionales para la instalación / Optional materials for installation **Rendimiento Aprox. / Average Usage** **Precio / Price**

	○ MSA-3 Masilla de Pegado	1 Cartucho 4 - 5 Paneles	-
	● PTE-24 Pintura Envejecido Rojo	1 Spray 15 Paneles	-
	● PTE-21 Pintura Envejecido Marrón	1 Spray 15 Paneles	-

Brick LADRILLO LOFT

ACABADOS / FINISHES



530
Envejecido /
Aged

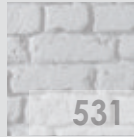

531
Blanco /
White

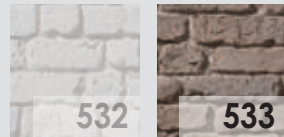

532
Blanco Antiguo /
Old White

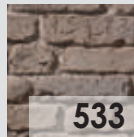

533
Marrón /
Brown

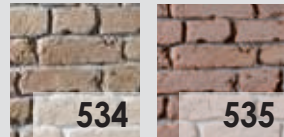

534
Marrón Tierra /
Earthy Brown

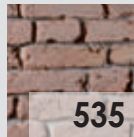

535
Natural /
Natural

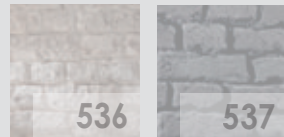

536
Industrial /
Industrial



537
Gris Carbón /
Carbon Grey

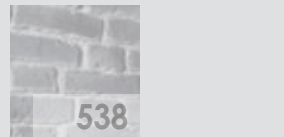

538
Gris Combinado /
Two Tone Grey

MEDIDAS / MEASUREMENTS

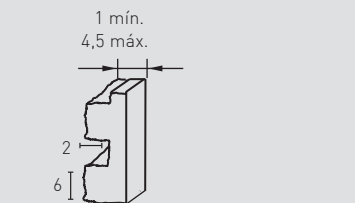
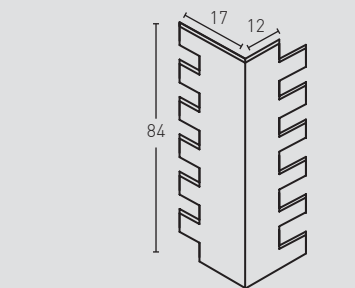
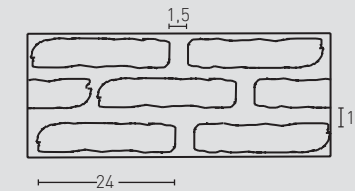
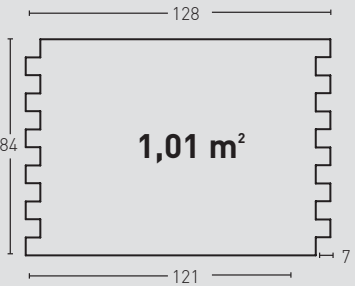
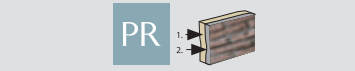

PRODUCTO / PRODUCT	COD.	DESCRIPCIÓN / DESCRIPTION	KG	PR	PR	PR	PR
PR	533 533-E	Panel Ladrillo Loft Marrón Ángulo Ladrillo Loft Marrón	PR: 8-9 kg PR: 4-5 kg	PR: 3 un PR: 6 un	PR: 36 un PR: 30 un	PR	€/unidad - -

Complementos necesarios para la instalación / Necessary materials for installation

Complementos necesarios para la instalación / Necessary materials for installation	Rendimiento Aprox. / Average Usage	Precio / Price
● MSA-50 Masilla Juntas Oscuro	1 Cartucho 2 Paneles	-
● PT-12 Pintura Junta Oscura	1 Bote 25 Paneles	-
● PTX-56 Pintura Crema	1 Spray 15 Paneles	-

Complementos opcionales para la instalación / Optional materials for installation

Complementos opcionales para la instalación / Optional materials for installation	Rendimiento Aprox. / Average Usage	Precio / Price
○ MSA-3 Masilla de Pegado	1 Cartucho 4 - 5 Paneles	-
● PTX-57 Pintura Marrón Ladrillo Oscuro	1 Spray 15 Paneles	-
● PTX-58 Pintura Marrón Ladrillo Claro	1 Spray 15 Paneles	-
● PTX-19 Pintura Antracita	1 Spray 15 Paneles	-

PRODUCTO / PRODUCT	COD.	DESCRIPCIÓN / DESCRIPTION	KG	PR	PR	PR	PR
PR	534 534-E	Panel Ladrillo Loft Marrón Tierra Ángulo Ladr. Loft Marrón Tierra	PR: 8-9 kg PR: 4-5 kg	PR: 3 un PR: 6 un	PR: 36 un PR: 30 un	PR	€/unidad - -

Complementos necesarios para la instalación / Necessary materials for installation

Complementos necesarios para la instalación / Necessary materials for installation	Rendimiento Aprox. / Average Usage	Precio / Price
● MSA-10 Masilla Beige	1 Cartucho 2 - 3 Paneles	-
● PTX-01 Pintura Beige Pizarra	1 Spray 8 Paneles	-
● PTX-07 Ocre	1 Spray 15 Paneles	-

Complementos opcionales para la instalación / Optional materials for installation

Complementos opcionales para la instalación / Optional materials for installation	Rendimiento Aprox. / Average Usage	Precio / Price
○ MSA-3 Masilla de Pegado	1 Cartucho 4 - 5 Paneles	-
● PTX-59 Pintura Marrón Embero	1 Spray 15 Paneles	-
● PTE-31 Óxido Amarillo	1 Spray 15 Paneles	-
● PTX-501 Pintura Rojo Oscuro	1 Spray 15 Paneles	-

PRODUCTO / PRODUCT	COD.	DESCRIPCIÓN / DESCRIPTION	KG	PR	PR	PR	PR
PR	535 535-E	Panel Ladrillo Loft Natural Ángulo Ladrillo Loft Natural	PR: 8-9 kg PR: 4-5 kg	PR: 3 un PR: 6 un	PR: 36 un PR: 30 un	PR	€/unidad - -

Complementos necesarios para la instalación / Necessary materials for installation

Complementos necesarios para la instalación / Necessary materials for installation	Rendimiento Aprox. / Average Usage	Precio / Price
● MSA-50 Masilla Juntas Oscuro	1 Cartucho 2 - 3 Paneles	-
● PT-12 Pintura Junta Oscura	1 Bote 25 Paneles	-
● PTX-56 Pintura Crema	1 Spray 15 Paneles	-

Complementos opcionales para la instalación / Optional materials for installation

Complementos opcionales para la instalación / Optional materials for installation	Rendimiento Aprox. / Average Usage	Precio / Price
○ MSA-3 Masilla de Pegado	1 Cartucho 4 - 5 Paneles	-
● PTX-34 Ladrillo Arcilloso	1 Spray 15 Paneles	-
● PTX-58 Pintura Marrón Ladrillo Claro	1 Spray 15 Paneles	-
● PTE-31 Óxido Amarillo	1 Spray 15 Paneles	-

Las medidas pueden variar +/-1cm / Measurements may vary +/-1cm

Brick LADRILLO LOFT

ACABADOS / FINISHES



530
Envejecido /
Aged

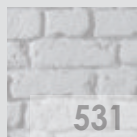

531
Blanco /
White

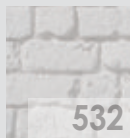

532
Blanco Antiguo /
Old White

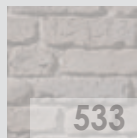

533
Marrón /
Brown

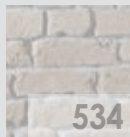

534
Marrón Tierra /
Earthy Brown

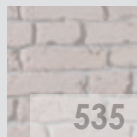

535
Natural /
Natural

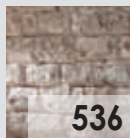

536
Industrial /
Industrial

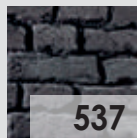

537
Gris Carbón /
Carbon Grey

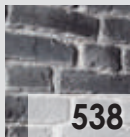

538
Gris Combinado /
Two Tone Grey

MEDIDAS / MEASUREMENTS

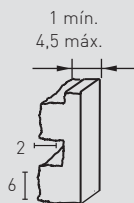
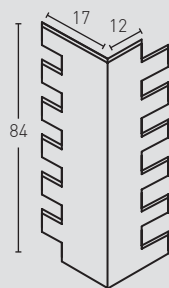
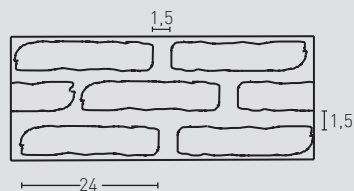
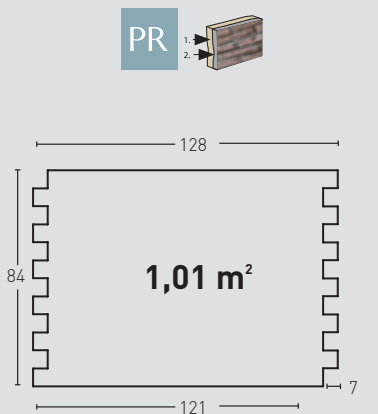

Las medidas pueden variar +/- 1cm / Measurements may vary +/- 1cm

PRODUCTO PRODUCT	COD.	DESCRIPCIÓN DESCRIPTION	KG			PR	€/unidad
PR	536 536-E	Panel Ladrillo Loft Industrial	PR: 8-9 kg	PR: 3 un	PR: 36 un	-	-
		Ángulo Ladrillo Loft Industrial	PR: 4-5 kg	PR: 6 un	PR: 30 un	-	-

Complementos necesarios para la instalación / Necessary materials for installation **Rendimiento Aprox. / Average Usage** **Precio / Price**

	<input type="checkbox"/> MSA-70 Masilla Blanco Italia	1 Cartucho 2 Paneles	-
	<input type="checkbox"/> PTX-20 Pintura Blanco Italia	1 Bote 8 Paneles	-
	<input type="checkbox"/> PTE-33 Pintura Envejecido Caleado + Comp6 (Bote)	1 Spray 10 Paneles	-

Complementos opcionales para la instalación / Optional materials for installation **Rendimiento Aprox. / Average Usage** **Precio / Price**

	<input type="checkbox"/> MSA-3 Masilla de Pegado	1 Cartucho 4 - 5 Paneles	-
	<input type="checkbox"/> PTX-80 Pintura Teja-Marrón	1 Spray 15 Paneles	-
	<input type="checkbox"/> PTX-09 Pintura Marrón	1 Spray 15 Paneles	-

PRODUCTO PRODUCT	COD.	DESCRIPCIÓN DESCRIPTION	KG			PR	€/unidad
PR	537 537-E	Panel Ladrillo Loft Gris Carbón	PR: 8-9 kg	PR: 3 un	PR: 36 un	-	-
		Ángulo Ladrillo Loft Gris Carbón	PR: 4-5 kg	PR: 6 un	PR: 30 un	-	-

Complementos necesarios para la instalación / Necessary materials for installation **Rendimiento Aprox. / Average Usage** **Precio / Price**

	<input checked="" type="checkbox"/> MSA-30 Masilla Juntas Gris	1 Cartucho 2 Paneles	-
	<input checked="" type="checkbox"/> PT-68 Pintura Junta Ladrillo Antracita	1 Spray 8 Paneles	-
	<input checked="" type="checkbox"/> PT-91 Pintura Gris Carbón	1 Spray 15 Paneles	-

Complementos opcionales para la instalación / Optional materials for installation **Rendimiento Aprox. / Average Usage** **Precio / Price**

	<input type="checkbox"/> MSA-3 Masilla de Pegado	1 Cartucho 4 Paneles	-
--	--	----------------------	---

PRODUCTO PRODUCT	COD.	DESCRIPCIÓN DESCRIPTION	KG			PR	€/unidad
PR	538 538-E	Panel Ladrillo Loft Gris Comb.	PR: 8-9 kg	PR: 3 un	PR: 36 un	-	-
		Ángulo Lad. Loft Gris Comb.	PR: 4-5 kg	PR: 6 un	PR: 30 un	-	-

Complementos necesarios para la instalación / Necessary materials for installation **Rendimiento Aprox. / Average Usage** **Precio / Price**

	<input checked="" type="checkbox"/> MSA-10 Masilla Juntas Beige	1 Cartucho 2 Paneles	-
	<input checked="" type="checkbox"/> PT-69 Pintura Junta Ladrillo Gris Combinado	1 Spray 8 Paneles	-
	<input checked="" type="checkbox"/> PTX-92 Pintura Ladrillo Gris Combinado	1 Spray 15 Paneles	-

Complementos opcionales para la instalación / Optional materials for installation **Rendimiento Aprox. / Average Usage** **Precio / Price**

	<input type="checkbox"/> MSA-3 Masilla de Pegado	1 Cartucho 4 Paneles	-
--	--	----------------------	---

Brick LADRILLO OLD BRITISH

PANELPIEDRA®

PR

HD



PR 550 Envejecido



PR 555 Natural



PR 553 Marrón



PR 557 Gris Combinado

Brick LADRILLO OLD BRITISH

ACABADOS / FINISHES



550
Envejecido /
Aged

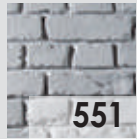

551
Blanco /
White

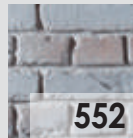

552
Blanco Antiguo /
Old White

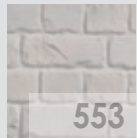

553
Marrón /
Brown

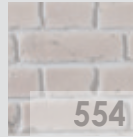

554
Marrón Tierra /
Earthy Brown



555
Natural /
Natural



556
Gris Carbón /
Carbon Grey

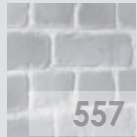

557
Gris Combinado /
Two Tone Grey

MEDIDAS / MEASUREMENTS

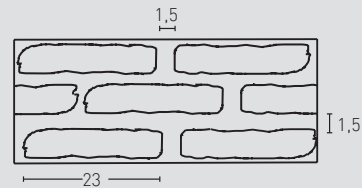
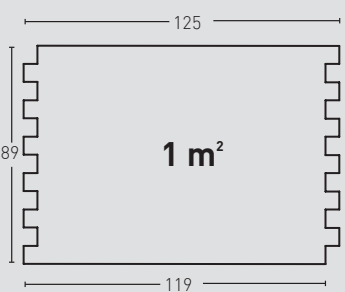

Las medidas pueden variar +/-1cm / Measurements may vary +/-1cm

PRODUCTO PRODUCT	COD.	DESCRIPCIÓN DESCRIPTION	KG			PR	HD
PR HD	550	Panel L. Old British Envejecido	PR:6-7kg / HD:15-20kg	PR:5un / HD:25un	PR:60un / HD:25un	-	-

Complementos necesarios para la instalación / Necessary materials for installation

	Rendimiento Aprox. / Average Usage	Precio / Price
● MSA-50 Masilla Juntas Oscuro	1 Cartucho 2 - 3 Paneles	-
● PT-12 Pintura Junta Oscura	1 Bote 25 Paneles	-
● PTX-501 Pintura Rojo Oscuro	1 Spray 15 Paneles	-
● Comp-09 Esparto Rojo	1 Pliego 20 Paneles	-

Complementos opcionales para la instalación / Optional materials for installation

	Rendimiento Aprox. / Average Usage	Precio / Price
○ MSA-3 Masilla de Pegado	1 Cartucho 4 - 5 Paneles	-
● PTX-11 Pintura Rojo Viejo	1 Spray 15 Paneles	-
● PTX-500 Pintura Rojo Claro	1 Spray 15 Paneles	-
● PTX-19 Pintura Antracita	1 Spray 15 Paneles	-

PRODUCTO PRODUCT	COD.	DESCRIPCIÓN DESCRIPTION	KG			PR	HD
PR HD	551	Panel Ladr. Old British Blanco	PR:6-7kg / HD:15-20kg	PR:5un / HD:25un	PR:60un / HD:25un	-	-

Complementos necesarios para la instalación / Necessary materials for installation

	Rendimiento Aprox. / Average Usage	Precio / Price
○ MSA-70 Masilla Juntas Blanco Italia	1 Cartucho 2 - 3 Paneles	-
○ PTX-10 Pintura Blanco Nieve	1 Spray 8 Paneles	-

Complementos opcionales para la instalación / Optional materials for installation

	Rendimiento Aprox. / Average Usage	Precio / Price
○ MSA-3 Masilla de Pegado	1 Cartucho 4 - 5 Paneles	-

PRODUCTO PRODUCT	COD.	DESCRIPCIÓN DESCRIPTION	KG			PR	HD
PR HD	552	P. Lad. Old British Blanco Antiguo	PR:6-7kg / HD:15-20kg	PR:5un / HD:25un	PR:60un / HD:25un	-	-

Complementos necesarios para la instalación / Necessary materials for installation

	Rendimiento Aprox. / Average Usage	Precio / Price
○ MSA-70 Masilla Blanco Italia	1 Cartucho 2 - 3 Paneles	-
○ PTX-20 Pintura Blanco Italia	1 Spray 8 Paneles	-
● PTX-51 Pintura Blanco Azulado	1 Spray 8 Paneles	-

Complementos opcionales para la instalación / Optional materials for installation

	Rendimiento Aprox. / Average Usage	Precio / Price
○ MSA-3 Masilla de Pegado	1 Cartucho 4 - 5 Paneles	-
● PTE-24 Pintura Envejecido Rojo	1 Spray 15 Paneles	-
● PTE-21 Pintura Envejecido Marrón	1 Spray 15 Paneles	-

Brick LADRILLO OLD BRITISH

ACABADOS / FINISHES



550
Envejecido / Aged

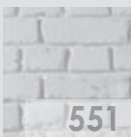

551
Blanco / White

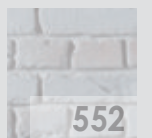

552
Blanco Antiguo / Old White

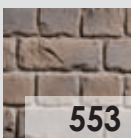

553
Marrón / Brown

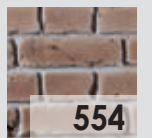

554
Marrón Tierra / Earthy Brown



555
Natural / Natural

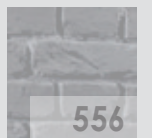

556
Gris Carbón / Carbon Grey

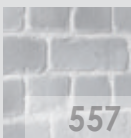

557
Gris Combinado / Two Tone Grey

MEDIDAS / MEASUREMENTS

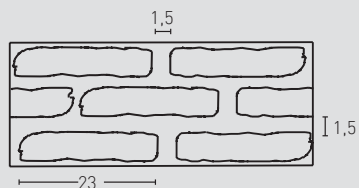
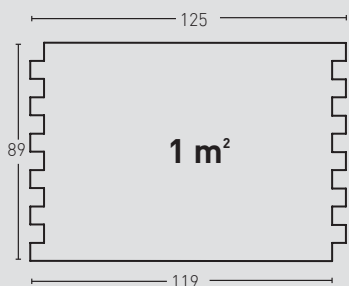

Las medidas pueden variar +/-1cm / Measurements may vary +/-1cm

PRODUCTO PRODUCT	COD.	DESCRIPCIÓN DESCRIPTION	KG			PR	HD
PR	HD	553	Panel Lad. Old British Marrón	PR:6-7kg / HD:15-20kg	PR:5un / HD:25un	PR:60un / HD:25un	€/unidad - -
Complementos necesarios para la instalación / Necessary materials for installation			Rendimiento Aprox. / Average Usage		Precio / Price		
	● MSA-50 Masilla Juntas Oscuro			1 Cartucho 2 - 3 Paneles	-		
	● PT-12 Pintura Junta Oscuro			1 Bote 25 Paneles	-		
	● PTX-56 Pintura Crema			1 Spray 15 Paneles	-		
Complementos opcionales para la instalación / Optional materials for installation			Rendimiento Aprox. / Average Usage		Precio / Price		
	○ MSA-3 Masilla de Pegado			1 Cartucho 4 - 5 Paneles	-		
	● PTX-57 Pintura Marrón Ladrillo Oscuro			1 Spray 15 Paneles	-		
	● PTX-58 Pintura Marrón Ladrillo Claro			1 Spray 15 Paneles	-		
	● PTX-19 Pintura Antracita			1 Spray 15 Paneles	-		
PRODUCTO PRODUCT	COD.	DESCRIPCIÓN DESCRIPTION	KG			PR	HD
PR	HD	554	Panel Lad. Old British Marrón tierra	PR:6-7kg / HD:15-20kg	PR:5un / HD:25un	PR:60un / HD:25un	€/unidad - -
Complementos necesarios para la instalación / Necessary materials for installation			Rendimiento Aprox. / Average Usage		Precio / Price		
	● MSA-10 Masilla Juntas Beige			1 Cartucho 2 - 3 Paneles	-		
	● PTX-01 Pintura Beige Pizarra			1 Spray 8 Paneles	-		
	● PTX-07 Ocre			1 Spray 15 Paneles	-		
Complementos opcionales para la instalación / Optional materials for installation			Rendimiento Aprox. / Average Usage		Precio / Price		
	○ MSA-3 Masilla de Pegado			1 Cartucho 4 - 5 Paneles	-		
	● PTX-59 Pintura Marrón Embero			1 Spray 15 Paneles	-		
	● PTE-31 Pintura Envejecido Piel			1 Spray 15 Paneles	-		
	● PTX-501 Pintura Rojo Oscuro			1 Spray 15 Paneles	-		
PRODUCTO PRODUCT	COD.	DESCRIPCIÓN DESCRIPTION	KG			PR	HD
PR	HD	555	Panel Lad. Old British Natural	PR:6-7kg / HD:15-20kg	PR:5un / HD:25un	PR:60un / HD:25un	€/unidad - -
Complementos necesarios para la instalación / Necessary materials for installation			Rendimiento Aprox. / Average Usage		Precio / Price		
	● MSA-50 Masilla Juntas Oscuro			1 Cartucho 2 - 3 Paneles	-		
	● PT-12 Pintura Junta Oscura			1 Bote 25 Paneles	-		
	● PTX-56 Pintura Crema			1 Spray 8 Paneles	-		
Complementos opcionales para la instalación / Optional materials for installation			Rendimiento Aprox. / Average Usage		Precio / Price		
	○ MSA-3 Masilla de Pegado			1 Cartucho 4 - 5 Paneles	-		
	● PTX-34 Ladrillo Arcilloso			1 Spray 15 Paneles	-		
	● PTX-58 Pintura Marrón Ladrillo Claro			1 Spray 15 Paneles	-		
	● PTE-31 Óxido Amarillo			1 Spray 15 Paneles	-		

Brick LADRILLO OLD BRITISH

ACABADOS / FINISHES



550
Envejecido /
Aged

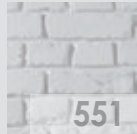

551
Blanco /
White

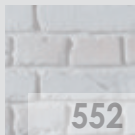

552
Blanco Antiguo /
Old White

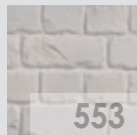

553
Marrón /
Brown

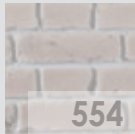

554
Marrón Tierra /
Earthy Brown



555
Natural /
Natural

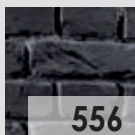

556
Gris Carbón /
Carbon Grey

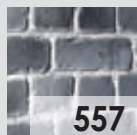

557
Gris Combinado /
Two Tone Grey

MEDIDAS / MEASUREMENTS

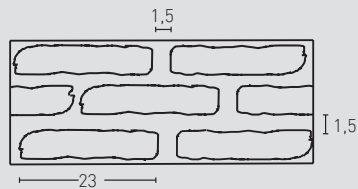
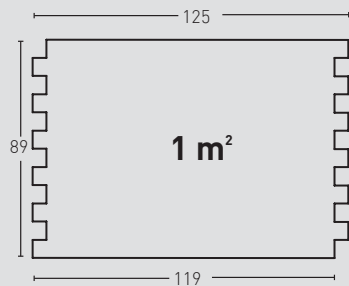

Las medidas pueden variar +/- 1cm / Measurements may vary +/- 1cm

PRODUCTO PRODUCT	COD.	DESCRIPCIÓN DESCRIPTION	KG			PR	HD
PR HD	556	Panel Lad. Old British Gris Carbón	PR:6-7kg / HD:15-20kg	PR:5un / HD:25un	PR:60un / HD:25un	-	-

Complementos necesarios para la instalación / Necessary materials for installation



- MSA-30 Masilla Juntas Gris
- PT-68 Pintura Junta Ladrillo Antracita
- PT-91 Pintura Gris Carbón

- Rendimiento Aprox. / Average Usage
- 1 Cartucho 2 Paneles
 - 1 Spray 8 Paneles
 - 1 Spray 15 Paneles

Precio / Price

Complementos opcionales para la instalación / Optional materials for installation



- MSA-3 Masilla de Pegado

- Rendimiento Aprox. / Average Usage
- 1 Cartucho 4 Paneles

Precio / Price

PRODUCTO PRODUCT	COD.	DESCRIPCIÓN DESCRIPTION	KG			PR	HD
PR HD	557	Panel Lad. Old British Gris Combinado	PR:6-7kg / HD:15-20kg	PR:5un / HD:25un	PR:60un / HD:25un	-	-

Complementos necesarios para la instalación / Necessary materials for installation



- MSA-10 Masilla Juntas Beige
- PT-69 Pintura Junta Ladrillo Gris Combinado
- PTX-92 Pintura Ladrillo Gris Combinado

- Rendimiento Aprox. / Average Usage
- 1 Cartucho 2 Paneles
 - 1 Spray 8 Paneles
 - 1 Spray 15 Paneles

Precio / Price

Complementos opcionales para la instalación / Optional materials for installation



- MSA-3 Masilla de Pegado

- Rendimiento Aprox. / Average Usage
- 1 Cartucho 4 Paneles

Precio / Price

Brick
LADRILLO
BRITISH

PANELPIEDRA®

PR



PR 542 Blanco Antiguo



PR 540 Envejecido

Brick LADRILLO BRITISH

ACABADOS / FINISHES



540
Envejecido / Aged

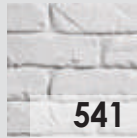

541
Blanco / White

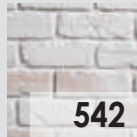

542
Blanco Antiguo / Old White

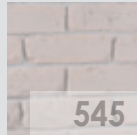

545
Natural / Natural

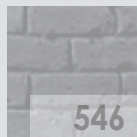

546
Gris Carbón / Carbon Grey



547
Gris Combinado / Two Tone Grey

MEDIDAS / MEASUREMENTS

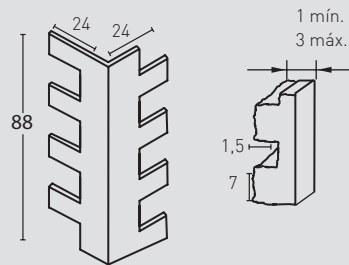
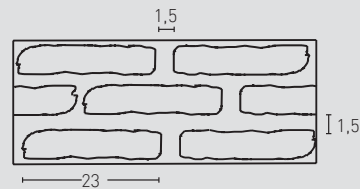
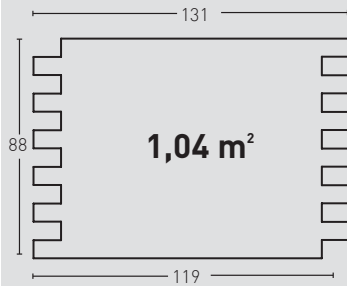
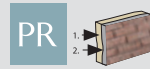

PRODUCTO / PRODUCT	COD.	DESCRIPCIÓN / DESCRIPTION	KG	PR	PR	PR	PR
PR	540 540-E	Panel Ladr. British Envejecido Ángulo Ladr. British Envejecido	PR: 6-7 kg PR: 3 kg	PR: 5un PR: 2un	PR: 60un PR: 30un	- -	€/unidad

Complementos necesarios para la instalación / Necessary materials for installation			Rendimiento Aprox. / Average Usage		Precio / Price	
	● MSA-50 Masilla Juntas Oscuro		1 Cartucho 2 - 3 Paneles	-		
	● PT-12 Pintura Junta Oscura		1 Bote 25 Paneles	-		
	● PTX-501 Pintura Rojo Oscuro		1 Spray 15 Paneles	-		
	● Comp-09 Esparto Rojo		1 Pliego 20 Paneles	-		

Complementos opcionales para la instalación / Optional materials for installation			Rendimiento Aprox. / Average Usage		Precio / Price	
	○ MSA-3 Masilla de Pegado		1 Cartucho 4 - 5 Paneles	-		
	● PTX-11 Pintura Rojo Viejo		1 Spray 15 Paneles	-		
	● PTX-500 Pintura Rojo Claro		1 Spray 15 Paneles	-		
	● PTX-19 Pintura Antracita		1 Spray 15 Paneles	-		

PRODUCTO / PRODUCT	COD.	DESCRIPCIÓN / DESCRIPTION	KG	PR	PR	PR	PR
PR	541 541-E	Panel Ladrillo British Blanco Ángulo Ladrillo British Blanco	PR: 6-7 kg PR: 3 kg	PR: 5un PR: 2un	PR: 60un PR: 30un	- -	€/unidad

Complementos necesarios para la instalación / Necessary materials for installation			Rendimiento Aprox. / Average Usage		Precio / Price	
	○ MSA-70 Masilla Juntas Blanco Italia		1 Cartucho 2 - 3 Paneles	-		
	○ PTX-10 Pintura Blanco Nieve		1 Spray 8 Paneles	-		

Complementos opcionales para la instalación / Optional materials for installation			Rendimiento Aprox. / Average Usage		Precio / Price	
	○ MSA-3 Masilla de Pegado		1 Cartucho 4 - 5 Paneles	-		

PRODUCTO / PRODUCT	COD.	DESCRIPCIÓN / DESCRIPTION	KG	PR	PR	PR	PR
PR	542 542-E	Panel L. British Blanco Antiguo Ángulo L. British Blanco Antiguo	PR: 6-7 kg PR: 3 kg	PR: 5un PR: 2un	PR: 60un PR: 30un	- -	€/unidad

Complementos necesarios para la instalación / Necessary materials for installation			Rendimiento Aprox. / Average Usage		Precio / Price	
	○ MSA-70 Masilla Blanco Italia		1 Cartucho 2 - 3 Paneles	-		
	○ PTX-20 Pintura Blanco Italia		1 Spray 8 Paneles	-		
	● PTX-51 Pintura Blanco Azulado		1 Spray 8 Paneles	-		

Complementos opcionales para la instalación / Optional materials for installation			Rendimiento Aprox. / Average Usage		Precio / Price	
	○ MSA-3 Masilla de Pegado		1 Cartucho 4 - 5 Paneles	-		
	● PTE-24 Pintura Envejecido Rojo		1 Spray 15 Paneles	-		
	● PTE-21 Pintura Envejecido Marrón		1 Spray 15 Paneles	-		

Las medidas pueden variar +/-1cm / Measurements may vary +/-1cm

Brick LADRILLO BRITISH

ACABADOS / FINISHES

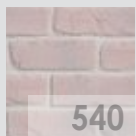

540

Envejecido / Aged

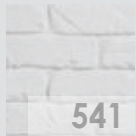

541

Blanco / White

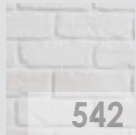

542

Blanco Antiguo / Old White

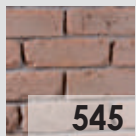

545

Natural / Natural

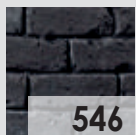

546

Gris Carbón / Carbon Grey



547

Gris Combinado / Two Tone Grey

MEDIDAS / MEASUREMENTS

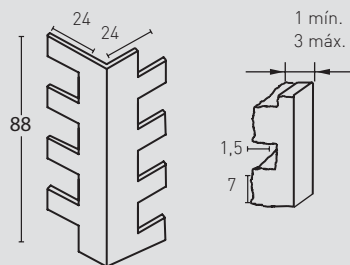
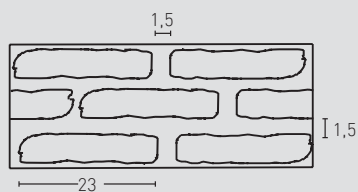
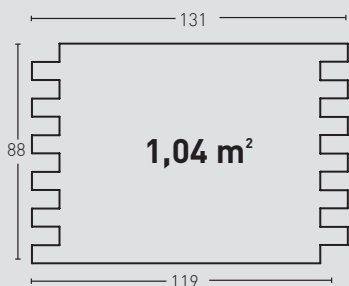

PRODUCTO / PRODUCT	COD.	DESCRIPCIÓN / DESCRIPTION	KG	PR	PR	PR	PR
PR	545 545-E	Panel Ladrillo British Natural Ángulo Ladrillo British Natural	PR: 6-7 kg PR: 3 kg	PR: 5un PR: 2un	PR: 60un PR: 30un	PR	€/unidad - -

Complementos necesarios para la instalación / Necessary materials for installation

Complementos necesarios para la instalación / Necessary materials for installation	Rendimiento Aprox. / Average Usage	Precio / Price
● MSA-50 Masilla Juntas Oscuro	1 Cartucho 2 - 3 Paneles	-
● PT-12 Pintura Junta Oscura	1 Spray 8 Paneles	-
● PTX-56 Pintura Crema	1 Spray 15 Paneles	-

Complementos opcionales para la instalación / Optional materials for installation

Complementos opcionales para la instalación / Optional materials for installation	Rendimiento Aprox. / Average Usage	Precio / Price
○ MSA-3 Masilla de Pegado	1 Cartucho 4 - 5 Paneles	-
● PTX-34 Ladrillo Arcilloso	1 Spray 15 Paneles	-
● PTX-58 Pintura Marrón Ladrillo Claro	1 Spray 15 Paneles	-
● PTX-31 Óxido Amarillo	1 Spray 15 Paneles	-

PRODUCTO / PRODUCT	COD.	DESCRIPCIÓN / DESCRIPTION	KG	PR	PR	PR	PR
PR	546 546-E	Panel Lad. British Gris Carbón Áng. Lad. British Gris Carbón	PR: 6-7 kg PR: 3 kg	PR: 5un PR: 2un	PR: 60un PR: 30un	PR	€/unidad - -

Complementos necesarios para la instalación / Necessary materials for installation

Complementos necesarios para la instalación / Necessary materials for installation	Rendimiento Aprox. / Average Usage	Precio / Price
● MSA-30 Masilla Juntas Gris	1 Cartucho 2 Paneles	-
● PT-68 Pintura Junta Ladrillo Antracita	1 Spray 8 Paneles	-
● PT-91 Pintura Gris Carbón	1 Spray 15 Paneles	-

Complementos opcionales para la instalación / Optional materials for installation

Complementos opcionales para la instalación / Optional materials for installation	Rendimiento Aprox. / Average Usage	Precio / Price
○ MSA-3 Masilla de Pegado	1 Cartucho 4 Paneles	-

PRODUCTO / PRODUCT	COD.	DESCRIPCIÓN / DESCRIPTION	KG	PR	PR	PR	PR
PR	547 547-E	P. Ladrillo British Gris Combin. Áng. Lad. British Gris Combin.	PR: 6-7 kg PR: 3 kg	PR: 5un PR: 2un	PR: 60un PR: 30un	PR	€/unidad - -

Complementos necesarios para la instalación / Necessary materials for installation

Complementos necesarios para la instalación / Necessary materials for installation	Rendimiento Aprox. / Average Usage	Precio / Price
● MSA-10 Masilla Juntas Beige	1 Cartucho 2 Paneles	-
● PT-69 Pintura Junta Ladrillo Gris Combinado	1 Spray 8 Paneles	-
● PTX-92 Pintura Ladrillo Gris Combinado	1 Spray 15 Paneles	-

Complementos opcionales para la instalación / Optional materials for installation

Complementos opcionales para la instalación / Optional materials for installation	Rendimiento Aprox. / Average Usage	Precio / Price
○ MSA-3 Masilla de Pegado	1 Cartucho 4 Paneles	-

Las medidas pueden variar +/- 1cm / Measurements may vary +/- 1cm

BRICK

Brick URBAN BRICK

PANELPIEDRA®

PR



PR 512 Blanco Antiguo



PR 509 Envejecido



PR 517 Gris Carbón



PR 518 Gris Combinado

Brick URBAN BRICK

ACABADOS / FINISHES

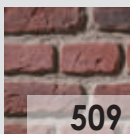

509
Envejecido /
Aged



511
Blanco /
White

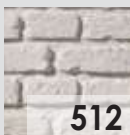

512
Blanco Antiguo /
Old White



513
Marrón /
Brown



515
Natural /
Natural



516
Envejec. Caleado /
Aged Whitewashed

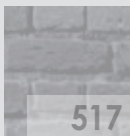

517
Gris Carbón /
Carbon Grey



518
Gris Combinado /
Two Tone Grey

MEDIDAS / MEASUREMENTS

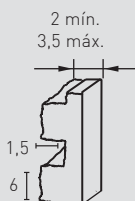
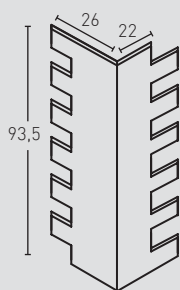
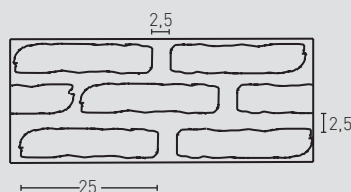
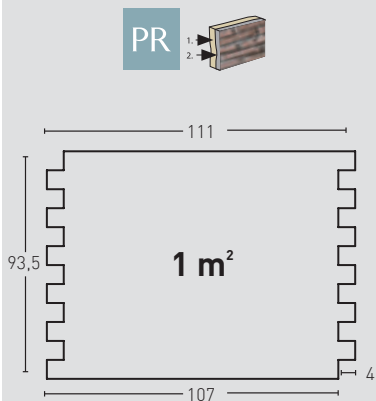

Las medidas pueden variar +/- 1cm / Measurements may vary +/- 1cm

PRODUCTO PRODUCT	COD.	DESCRIPCIÓN DESCRIPTION	KG			PR
PR	509 509-E	Panel Urban Brick Envejecido Ángulo Urban Brick Envejecido	PR: 6 - 7 kg PR: 3 kg	PR: 4 un PR: 2 un	PR: 48 un PR: 30 un	€/unidad - -

Complementos necesarios para la instalación / Necessary materials for installation

Complementos necesarios para la instalación / Necessary materials for installation	Rendimiento Aprox. / Average Usage	Precio / Price
● MSA-50 Masilla Juntas Oscuro	1 Cartucho 2 Paneles	-
● PT-12 Pintura Junta Oscura	1 Bote 25 Paneles	-
● PTX-501 Pintura Rojo Oscuro	1 Spray 15 Paneles	-
● Comp-09 Esparto Rojo	1 Pliego 20 Paneles	-

Complementos opcionales para la instalación / Optional materials for installation

Complementos opcionales para la instalación / Optional materials for installation	Rendimiento Aprox. / Average Usage	Precio / Price
○ MSA-3 Masilla de Pegado	1 Cartucho 4 - 5 Paneles	-
● PTX-11 Pintura Rojo Viejo	1 Spray 15 Paneles	-
● PTX-500 Pintura Rojo Claro	1 Spray 15 Paneles	-
● PTX-19 Pintura Antracita	1 Spray 15 Paneles	-

PRODUCTO PRODUCT	COD.	DESCRIPCIÓN DESCRIPTION	KG			PR
PR	511 511-E	Panel Urban Brick Blanco Ángulo Urban Brick Blanco	PR: 6 - 7 kg PR: 3 kg	PR: 4 un PR: 2 un	PR: 48 un PR: 30 un	€/unidad - -

Complementos necesarios para la instalación / Necessary materials for installation

Complementos necesarios para la instalación / Necessary materials for installation	Rendimiento Aprox. / Average Usage	Precio / Price
○ MSA-70 Masilla Juntas Blanco Italia	1 Cartucho 2 - 3 Paneles	-
○ PTX-10 Pintura Blanco Nieve	1 Spray 8 Paneles	-

Complementos opcionales para la instalación / Optional materials for installation

Complementos opcionales para la instalación / Optional materials for installation	Rendimiento Aprox. / Average Usage	Precio / Price
○ MSA-3 Masilla de Pegado	1 Cartucho 4 - 5 Paneles	-

PRODUCTO PRODUCT	COD.	DESCRIPCIÓN DESCRIPTION	KG			PR
PR	512 512-E	Panel Urban Brick Blanco Antiguo Áng. Urban Brick Blanco Antiguo	PR: 6 - 7 kg PR: 3 kg	PR: 4 un PR: 2 un	PR: 48 un PR: 30 un	€/unidad - -

Complementos necesarios para la instalación / Necessary materials for installation

Complementos necesarios para la instalación / Necessary materials for installation	Rendimiento Aprox. / Average Usage	Precio / Price
○ MSA-70 Masilla Blanco Italia	1 Cartucho 2 - 3 Paneles	-
○ PTX-20 Pintura Blanco Italia	1 Spray 8 Paneles	-
● PTX-51 Pintura Blanco Azulado	1 Spray 8 Paneles	-

Complementos opcionales para la instalación / Optional materials for installation

Complementos opcionales para la instalación / Optional materials for installation	Rendimiento Aprox. / Average Usage	Precio / Price
○ MSA-3 Masilla de Pegado	1 Cartucho 4 - 5 Paneles	-
● PTE-24 Pintura Envejecido Rojo	1 Spray 15 Paneles	-
● PTE-21 Pintura Envejecido Marrón	1 Spray 15 Paneles	-

Brick URBAN BRICK

ACABADOS / FINISHES



509
Envejecido /
Aged



511
Blanco /
White

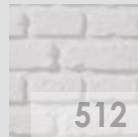

512
Blanco Antiguo /
Old White

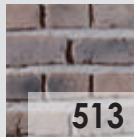

513
Marrón /
Brown



515
Natural /
Natural

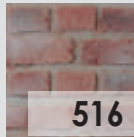

516
Envejec. Caleado /
Aged Whitewashed



517
Gris Carbón /
Carbon Grey



518
Gris Combinado /
Two Tone Grey

MEDIDAS / MEASUREMENTS

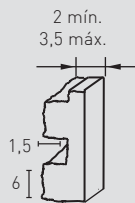
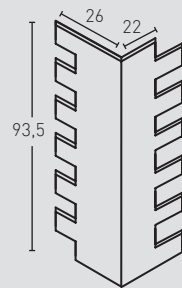
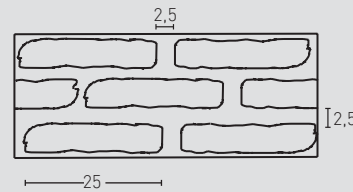
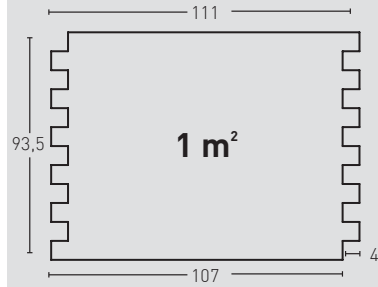
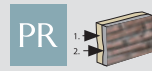

Las medidas pueden variar +/-1cm / Measurements may vary +/-1cm

PRODUCTO PRODUCT	COD.	DESCRIPCIÓN DESCRIPTION	KG			PR
PR	513 513-E	Panel Urban Brick Marrón Ángulo Urban Brick Marrón	PR: 6 - 7 kg PR: 3 kg	PR: 4 un PR: 2 un	PR: 48 un PR: 30 un	€/unidad - -

Complementos necesarios para la instalación / Necessary materials for installation

Complementos necesarios para la instalación / Necessary materials for installation	Rendimiento Aprox. / Average Usage	Precio / Price
● MSA-50 Masilla Juntas Oscuro	1 Cartucho 2 - 3 Paneles	-
● PT-12 Pintura Junta Oscuro	1 Bote 25 Paneles	-
● PTX-56 Pintura Crema	1 Spray 15 Paneles	-

Complementos opcionales para la instalación / Optional materials for installation

Complementos opcionales para la instalación / Optional materials for installation	Rendimiento Aprox. / Average Usage	Precio / Price
○ MSA-3 Masilla de Pegado	1 Cartucho 4 - 5 Paneles	-
● PTX-57 Pintura Marrón Ladrillo Oscuro	1 Spray 15 Paneles	-
● PTX-58 Pintura Marrón Ladrillo Claro	1 Spray 15 Paneles	-
● PTX-19 Pintura Antracita	1 Spray 15 Paneles	-

PRODUCTO PRODUCT	COD.	DESCRIPCIÓN DESCRIPTION	KG			PR
PR	515 515-E	Panel Urban Brick Natural Ángulo Urban Brick Natural	PR: 6 - 7 kg PR: 3 kg	PR: 4 un PR: 2 un	PR: 48 un PR: 30 un	€/unidad - -

Complementos necesarios para la instalación / Necessary materials for installation

Complementos necesarios para la instalación / Necessary materials for installation	Rendimiento Aprox. / Average Usage	Precio / Price
● MSA-50 Masilla Juntas Oscuro	1 Cartucho 2 - 3 Paneles	-
● PT-12 Pintura Junta Oscuro	1 Bote 25 Paneles	-
● PTX-56 Pintura Crema	1 Spray 15 Paneles	-

Complementos opcionales para la instalación / Optional materials for installation

Complementos opcionales para la instalación / Optional materials for installation	Rendimiento Aprox. / Average Usage	Precio / Price
○ MSA-3 Masilla de Pegado	1 Cartucho 4 - 5 Paneles	-
● PTX-34 Ladrillo Arcilloso	1 Spray 15 Paneles	-
● PTX-58 Pintura Marrón Ladrillo Claro	1 Spray 15 Paneles	-
● PTX-31 Óxido Amarillo	1 Spray 15 Paneles	-

PRODUCTO PRODUCT	COD.	DESCRIPCIÓN DESCRIPTION	KG			PR
PR	516 516-E	Panel Urban Brick Envej. Caleado Áng. Urban Brick Envej. Caleado	PR: 6 - 7 kg PR: 3 kg	PR: 4 un PR: 2 un	PR: 48 un PR: 30 un	€/unidad - -

Complementos necesarios para la instalación / Necessary materials for installation

Complementos necesarios para la instalación / Necessary materials for installation	Rendimiento Aprox. / Average Usage	Precio / Price
● MSA-50 Masilla Juntas Oscuro	1 Cartucho 2 - 3 Paneles	-
● PT-12 Pintura Junta Oscura	1 Bote 25 Paneles	-
○ PTE-33 Pintura Envejecido Caleado + Comp6 (Bote)	1 Spray 8 Paneles	-

Complementos opcionales para la instalación / Optional materials for installation

Complementos opcionales para la instalación / Optional materials for installation	Rendimiento Aprox. / Average Usage	Precio / Price
○ MSA-3 Masilla de Pegado	1 Cartucho 4 - 5 Paneles	-
● PTX-11 Pintura Rojo Viejo	1 Spray 15 Paneles	-
● PTX-500 Pintura Rojo Claro	1 Spray 15 Paneles	-
● PTX-501 Pintura Rojo Oscuro	1 Spray 15 Paneles	-
● PTX-19 Pintura Antracita	1 Spray 15 Paneles	-

Brick URBAN BRICK

ACABADOS / FINISHES

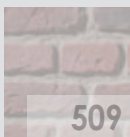

509
Envejecido /
Aged



511
Blanco /
White

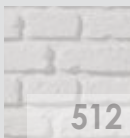

512
Blanco Antiguo /
Old White

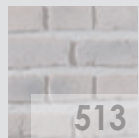

513
Marrón /
Brown



515
Natural /
Natural

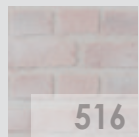

516
Envejec. Caleado /
Aged Whitewashed



517
Gris Carbón /
Carbon Grey

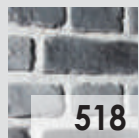

518
Gris Combinado /
Two Tone Grey

MEDIDAS / MEASUREMENTS

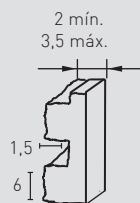
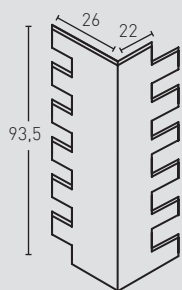
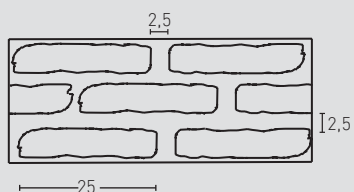
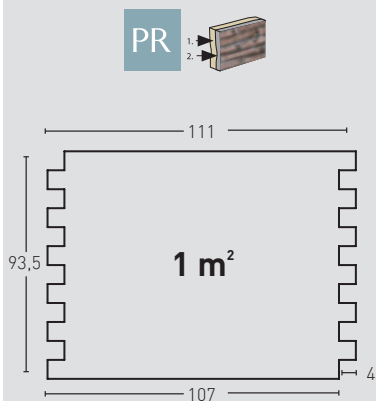

Las medidas pueden variar +/- 1cm / Measurements may vary +/- 1cm

PRODUCTO PRODUCT	COD.	DESCRIPCIÓN DESCRIPTION	KG			PR	€/unidad
PR	517 517-E	Panel Urban Brick Gris Carbón Ángulo Urban Brick Gris Carbón	PR: 6 - 7 kg PR: 3 kg	PR: 4 un PR: 2 un	PR: 48 un PR: 30 un	- -	- -

Complementos necesarios para la instalación / Necessary materials for installation			Rendimiento Aprox. / Average Usage		Precio / Price	
	● MSA-30 Masilla Juntas Gris		1 Cartucho 2 Paneles	-		
	● PT-68 Pintura Junta Ladrillo Antracita		1 Spray 8 Paneles	-		
	● PT-91 Pintura Gris Carbón		1 Spray 15 Paneles	-		

Complementos opcionales para la instalación / Optional materials for installation			Rendimiento Aprox. / Average Usage		Precio / Price	
	○ MSA-3 Masilla de Pegado		1 Cartucho 4 Paneles	-		

PRODUCTO PRODUCT	COD.	DESCRIPCIÓN DESCRIPTION	KG			PR	€/unidad
PR	518 518-E	P. Urban Brick Gris Combin. Áng. Urban Brick Gris Combin.	PR: 6 - 7 kg PR: 3 kg	PR: 4 un PR: 2 un	PR: 48 un PR: 30 un	- -	- -

Complementos necesarios para la instalación / Necessary materials for installation			Rendimiento Aprox. / Average Usage		Precio / Price	
	● MSA-10 Masilla Juntas Beige		1 Cartucho 2 Paneles	-		
	● PT-69 Pintura Junta Ladrillo Gris Combinado		1 Spray 8 Paneles	-		
	● PTX-92 Pintura Ladrillo Gris Combinado		1 Spray 15 Paneles	-		

Complementos opcionales para la instalación / Optional materials for installation			Rendimiento Aprox. / Average Usage		Precio / Price	
	○ MSA-3 Masilla de Pegado		1 Cartucho 4 Paneles	-		



REMEMBER®

Collection



REMEMBER®

Collection



TRÉSOR / 182-187



FENSTER / 188-191



SHUTTER / 192-195



LITTLE BURNED / 196-199

Remember TRESOR[®]

(2022 Patented Design©)

PANELPIEDRA[®]

PR

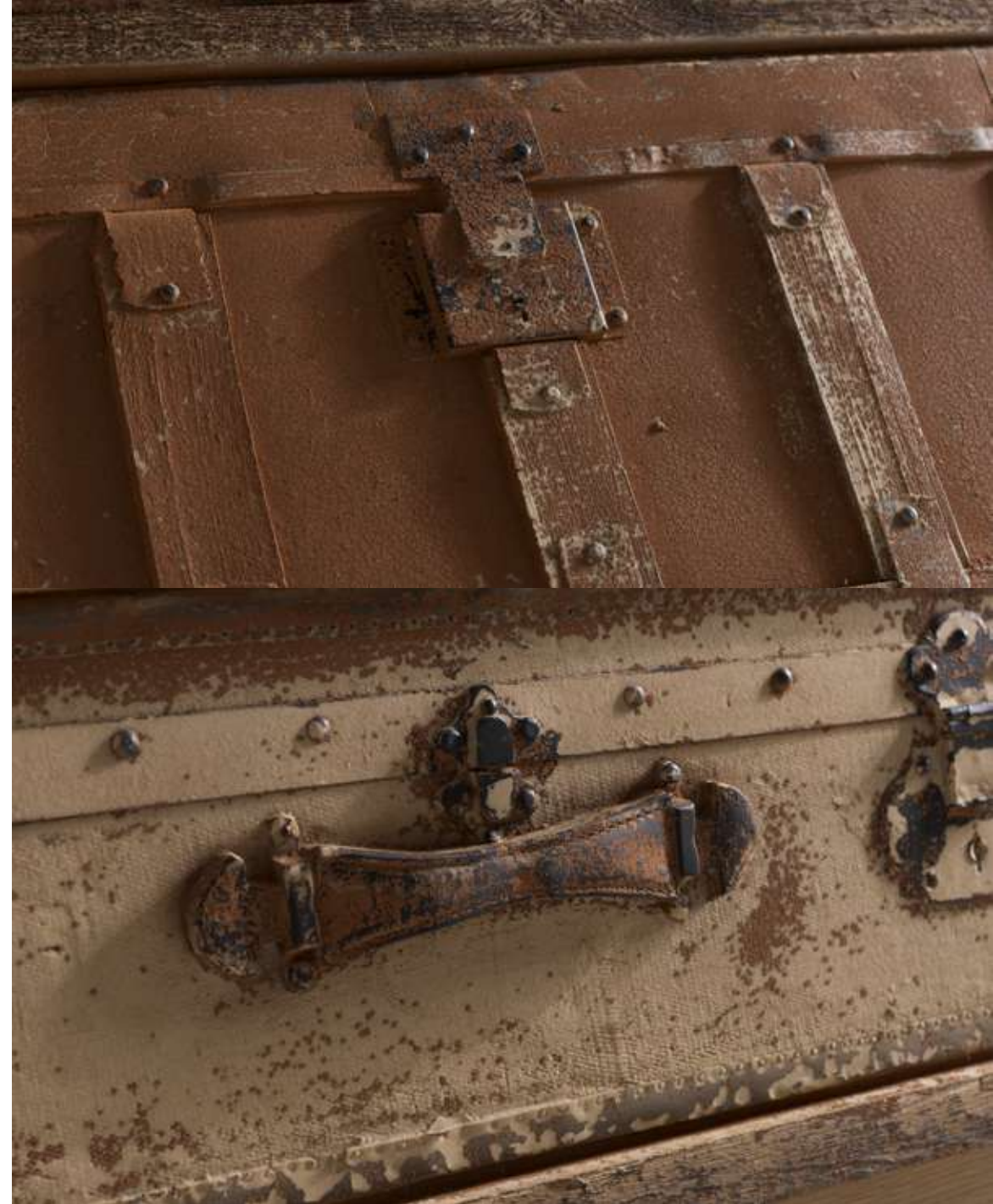

Craquelado Óxido



Craquelado Blanco



Craquelado Blanco



Craquelado Óxido



Blanco Italia

* Los 6 modelos de paneles se pueden combinar como se deseen / The 6 models of panels can be combined as desired

PANEL TRESOR -1

1



PANEL TRESOR -2

2



PANEL TRESOR -3

3



PANEL TRESOR -4

4



PANEL TRESOR -5

5



PANEL TRESOR -6

6



Remember TRESOR

ACABADOS / FINISHES



PR-890-1

Craquelado Blanco /
Cracked White



PR-890-2

Craquelado Blanco /
Cracked White



PR-891-1

Craquelado Óxido /
Cracked Rusty

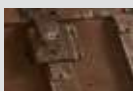

PR-891-2

Craquelado Óxido /
Cracked Rusty



PR-893-1

Blanco Italia /
Italia White



PR-893-2

Blanco Italia /
Italia White

MEDIDAS / MEASUREMENTS



Tresor-1
1,64 m²

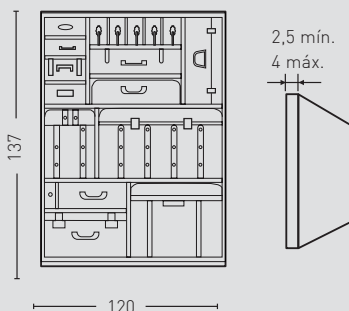

Tresor-2
1,64 m²

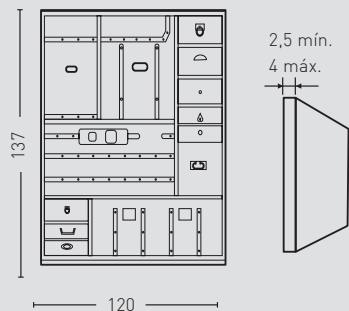

* Los 6 versiones de panel Tresor
(1 / 2 / 3 / 4 / 5 / 6)
se pueden combinar
como se deseen

The 6 versions of panel Tresor
(1 / 2 / 3 / 4 / 5 / 6)
can be combined as desired

PRODUCTO PRODUCT	COD.	DESCRIPCIÓN DESCRIPTION	KG			PR
PR	PR-890-1 PR-890-2	Panel Tresor Craquelado Blanco	PR: 10,5 kg	PR: --	PR: --	€/unidad -

Complementos necesarios para la instalación / Necessary materials for installation

Rendimiento Aprox. / Average Usage	Precio / Price
1 Cartucho 2 Paneles	-
1 Pintura 10 Paneles	-
1 Pintura 25 Paneles	-

Complementos opcionales para la instalación / Optional materials for installation

Rendimiento Aprox. / Average Usage	Precio / Price
1 Cartucho 3 - 4 Paneles	-

PRODUCTO PRODUCT	COD.	DESCRIPCIÓN DESCRIPTION	KG			PR
PR	PR-891-1 PR-891-2	Panel Tresor Craquelado Óxido	PR: 10,5 kg	PR: --	PR: --	€/unidad -

Complementos necesarios para la instalación / Necessary materials for installation

Rendimiento Aprox. / Average Usage	Precio / Price
1 Cartucho 2 Paneles	-
1 Pintura 10 Paneles	-
1 Pintura 25 Paneles	-

Complementos opcionales para la instalación / Optional materials for installation

Rendimiento Aprox. / Average Usage	Precio / Price
1 Cartucho 3 - 4 Paneles	-

PRODUCTO PRODUCT	COD.	DESCRIPCIÓN DESCRIPTION	KG			PR
PR	PR-893-1 PR-893-2	Panel Tresor Blanco Italia	PR: 10,5 kg	PR: --	PR: --	€/unidad -

Complementos necesarios para la instalación / Necessary materials for installation

Rendimiento Aprox. / Average Usage	Precio / Price
1 Cartucho 2 Paneles	-
1 Spray 10 Paneles	-

Complementos opcionales para la instalación / Optional materials for installation

Rendimiento Aprox. / Average Usage	Precio / Price
1 Cartucho 3 - 4 Paneles	-

Remember TRESOR

ACABADOS / FINISHES



PR-890-3

Craquelado Blanco /
Cracked White



PR-890-4

Craquelado Blanco /
Cracked White

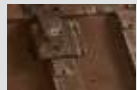

PR-891-3

Craquelado Óxido /
Cracked Rusty

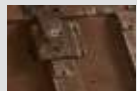

PR-891-4

Craquelado Óxido /
Cracked Rusty



PR-893-3

Blanco Italia /
Italia White



PR-893-4

Blanco Italia /
Italia White

MEDIDAS / MEASUREMENTS

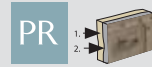

Tresor-3

1,36 m²

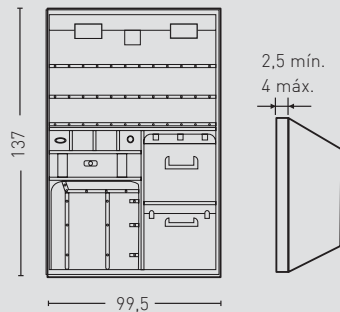

Tresor-4

1,36 m²

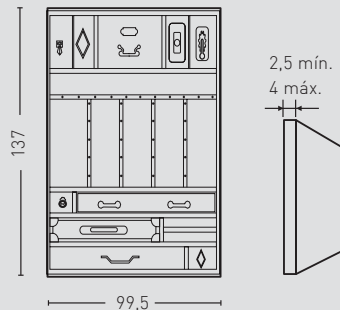

* Los 6 versiones de panel Tresor
(1 / 2 / 3 / 4 / 5 / 6)
se pueden combinar
como se deseen

The 6 versions of panel Tresor
(1 / 2 / 3 / 4 / 5 / 6)
can be combined as desired

PRODUCTO PRODUCT	COD.	DESCRIPCIÓN DESCRIPTION	KG			PR
PR	PR-890-3 PR-890-4	Panel Tresor Craquelado Blanco	PR: 9,5 kg	PR: --	PR: --	€/unidad -

Complementos necesarios para la instalación / Necessary materials for installation **Rendimiento Aprox. / Average Usage** **Precio / Price**

	○ MSA-70 Masilla Juntas Blanco Italia ○ PTX-90-375 Pintura Craquelado Blanco ● PTE-46 Pintura Envejecido Betún de Judea	1 Cartucho 2 Paneles 1 Pintura 10 Paneles 1 Pintura 25 Paneles	- - -
--	---	--	-------------

Complementos opcionales para la instalación / Optional materials for installation **Rendimiento Aprox. / Average Usage** **Precio / Price**

	○ MSA-3 Masilla de Pegado	1 Cartucho 4 - 5 Paneles	-
--	---------------------------	--------------------------	---

PRODUCTO PRODUCT	COD.	DESCRIPCIÓN DESCRIPTION	KG			PR
PR	PR-891-3 PR-891-4	Panel Tresor Craquelado Óxido	PR: 9,5 kg	PR: --	PR: --	€/unidad -

Complementos necesarios para la instalación / Necessary materials for installation **Rendimiento Aprox. / Average Usage** **Precio / Price**

	○ MSA-70 Masilla Juntas Blanco Italia ● PTX-93 Pintura Craquelado Acero Corte ● PTE-46-400 Pintura Envejecido Betún de Judea	1 Cartucho 2 Paneles 1 Pintura 10 Paneles 1 Pintura 25 Paneles	- - -
--	--	--	-------------

Complementos opcionales para la instalación / Optional materials for installation **Rendimiento Aprox. / Average Usage** **Precio / Price**

	○ MSA-3 Masilla de Pegado	1 Cartucho 4 - 5 Paneles	-
--	---------------------------	--------------------------	---

PRODUCTO PRODUCT	COD.	DESCRIPCIÓN DESCRIPTION	KG			PR
PR	PR-893-3 PR-893-4	Panel Tresor Blanco Italia	PR: 9,5 kg	PR: --	PR: --	€/unidad -

Complementos necesarios para la instalación / Necessary materials for installation **Rendimiento Aprox. / Average Usage** **Precio / Price**

	○ MSA-70 Masilla Juntas Blanco Italia ○ PTX-20-400 Pintura Blanco Italia	1 Cartucho 2 Paneles 1 Pintura 10 Paneles	- -
--	---	--	--------

Complementos opcionales para la instalación / Optional materials for installation **Rendimiento Aprox. / Average Usage** **Precio / Price**

	○ MSA-3 Masilla de Pegado	1 Cartucho 4 - 5 Paneles	-
--	---------------------------	--------------------------	---

Las medidas pueden variar +/-1cm / Measurements may vary +/-1cm

Remember TRESOR

ACABADOS / FINISHES



PR-890-5

Craquelado Blanco /
Cracked White



PR-890-6

Craquelado Blanco /
Cracked White

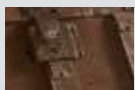

PR-891-5

Craquelado Óxido /
Cracked Rusty



PR-891-6

Craquelado Óxido /
Cracked Rusty



PR-893-5

Blanco Italia /
Italia White



PR-893-6

Blanco Italia /
Italia White

MEDIDAS / MEASUREMENTS



Tresor-5
1,20 m²

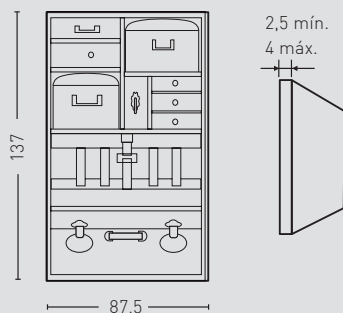

Tresor-6
1,20 m²

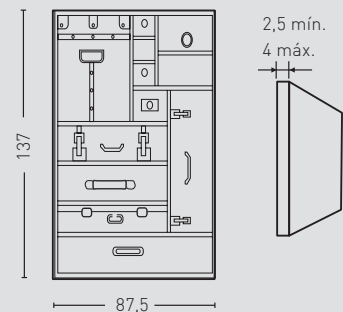

* Los 6 versiones de panel Tresor
(1 / 2 / 3 / 4 / 5 / 6)
se pueden combinar
como se deseen

The 6 versions of panel Tresor
(1 / 2 / 3 / 4 / 5 / 6)
can be combined as desired

PRODUCTO PRODUCT	COD.	DESCRIPCIÓN DESCRIPTION	KG			PR
PR	PR-890-5 PR-890-6	Panel Tresor Craquelado Blanco	PR: 8 kg	PR: --	PR: --	€/unidad -

Complementos necesarios para la instalación / Necessary materials for installation

Rendimiento Aprox. / Average Usage	Precio / Price
1 Cartucho 2 Paneles	-
1 Pintura 10 Paneles	-
1 Pintura 25 Paneles	-

Complementos opcionales para la instalación / Optional materials for installation

Rendimiento Aprox. / Average Usage	Precio / Price
1 Cartucho 4 - 5 Paneles	-

PRODUCTO PRODUCT	COD.	DESCRIPCIÓN DESCRIPTION	KG			PR
PR	PR-891-5 PR-891-6	Panel Tresor Craquelado Óxido	PR: 8 kg	PR: --	PR: --	€/unidad -

Complementos necesarios para la instalación / Necessary materials for installation

Rendimiento Aprox. / Average Usage	Precio / Price
1 Cartucho 2 Paneles	-
1 Pintura 10 Paneles	-
1 Pintura 25 Paneles	-

Complementos opcionales para la instalación / Optional materials for installation

Rendimiento Aprox. / Average Usage	Precio / Price
1 Cartucho 4 - 5 Paneles	-

PRODUCTO PRODUCT	COD.	DESCRIPCIÓN DESCRIPTION	KG			PR
PR	PR-893-5 PR-893-6	Panel Tresor Blanco Italia	PR: 8 kg	PR: --	PR: --	€/unidad -

Complementos necesarios para la instalación / Necessary materials for installation

Rendimiento Aprox. / Average Usage	Precio / Price
1 Cartucho 2 Paneles	-
1 Pintura 10 Paneles	-

Complementos opcionales para la instalación / Optional materials for installation

Rendimiento Aprox. / Average Usage	Precio / Price
1 Cartucho 4 - 5 Paneles	-

Remember FENSTER®

(2019 Patented Design©)

PANELPIEDRA®

PR



PR 810 Antracita



PR 810 Antracita

PR 810 Antracita



Remember FENSTER

ACABADOS / FINISHES

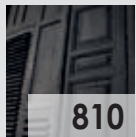

810
Antracita / Anthracite

MEDIDAS / MEASUREMENTS

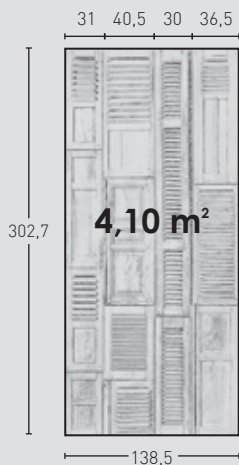

2,5 mín.
4,5 máx.



PRODUCTO PRODUCT	COD.	DESCRIPCIÓN DESCRIPTION	KG			PR	€/unidad
PR	810	Panel Fenster Antracita	PR: 31,5 kg	PR: --	PR: --	-	-
Complementos necesarios para la instalación / Necessary materials for installation				Rendimiento Aprox. / Average Usage		Precio / Price	
		● MSA-60 Masilla Juntas Antracita	1 Cartucho 1 Panel		-		-
		● PTX-86 Pintura Gris Ceniza	1 Pintura 3 Paneles		-		-
Complementos opcionales para la instalación / Optional materials for installation				Rendimiento Aprox. / Average Usage		Precio / Price	
		○ MSA-3 Masilla Pegado	1 Cartucho 2 Paneles		-		-

Las medidas pueden variar +/-1cm / Measurements may vary +/-1cm

REMEMBER

Remember SHUTTER®

(2019 Patented Design©)

PANELPIEDRA®

PR



PR 820 Antracita



PR 820 Antracita

PR 820 Antracita

Remember SHUTTER

ACABADOS / FINISHES

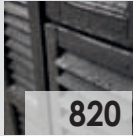

820
Antracita / Anthracite

MEDIDAS / MEASUREMENTS

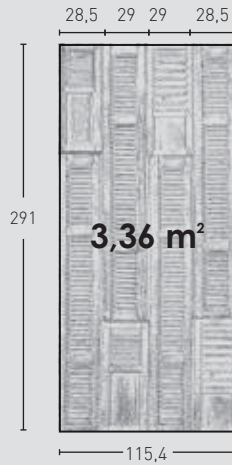

3,5 mín.
5 máx.



Las medidas pueden variar +/-1cm / Measurements may vary +/-1cm

PRODUCTO PRODUCT	COD.	DESCRIPCIÓN DESCRIPTION	KG			PR	€/unidad
PR	820	Panel Shutter Antracita	PR: 28 kg (7 kg cada tira)	PR: --	PR: --	-	-
Complementos necesarios para la instalación / Necessary materials for installation				Rendimiento Aprox. / Average Usage		Precio / Price	
		● MSA-60 Masilla Juntas Antracita	1 Cartucho 1 Panel		-		-
		● PTX-86 Pintura Gris Ceniza	1 Pintura 3 Paneles		-		-
Complementos opcionales para la instalación / Optional materials for installation				Rendimiento Aprox. / Average Usage		Precio / Price	
		○ MSA-3 Masilla Pegado	1 Cartucho 2 Paneles		-		-

REMEMBER

Remember
LITTLE
BURNED®

(2019 Patented Design©)

PANELPIEDRA®

PR



PR 850 Antracita



PR 850 Antracita

PR 850 Antracita

Remember LITTLE BURNED

ACABADOS / FINISHES

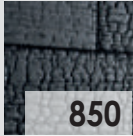

850

Antracita / Anthracite

MEDIDAS / MEASUREMENTS

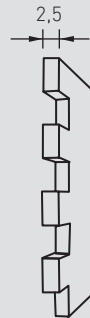
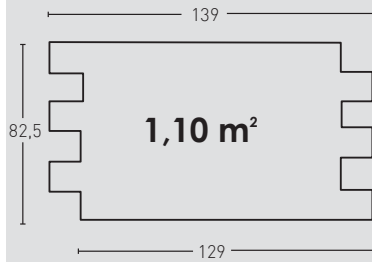

PRODUCTO PRODUCT	COD.	DESCRIPCIÓN DESCRIPTION	KG			PR	€/unidad
PR	850	Panel Little Burner Antracita	PR: 6-7 kg	PR: 5 un	PR: --	-	-
Complementos necesarios para la instalación / Necessary materials for installation				Rendimiento Aprox. / Average Usage		Precio / Price	
		● MSA-60 Masilla Juntas Antracita	1 Cartucho 1 Panel		-		-
		● PTX-86 Pintura Gris Ceniza	1 Pintura 8 Paneles		-		-
Complementos opcionales para la instalación / Optional materials for installation				Rendimiento Aprox. / Average Usage		Precio / Price	
		○ MSA-3 Masilla Pegado	1 Cartucho 4 Paneles		-		-



LIFESTYLE®

Collection



LIFESTYLE[®]

Collection



CAPITONE / 204-207



SYMPHONY / 208-211

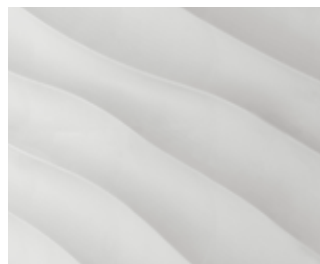

ELEGANCE / 212-215



ESSENCE / 216-219



GRAN GEOMÉTRICO / 220-223



DELPHI / 224-227

Lifestyle CAPITONE®

(2014 Patented Design©)

PANELPIEDRA®

PR



PR LF-472 Negro



PR LF-471 Blanco Italia



Lifestyle CAPITONE

ACABADOS / FINISHES



LF-471

Blanco Italia /
Italian White



LF-472

Negro /
Black

MEDIDAS / MEASUREMENTS

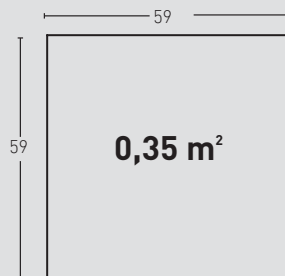

2,5 mín.
4 máx.



Las medidas pueden variar +/-1cm / Measurements may vary +/-1cm

PRODUCTO PRODUCT	COD.	DESCRIPCIÓN DESCRIPTION				PR	€/unidad
PR	LF-471	Panel Capitone Blanco Italia	PR: 3-4 kg	PR: 5 un	PR: 60 un	-	-

Complementos necesarios para la instalación / Necessary materials for installation



- MSA-70 Masilla Juntas Blanco Italia
- PTX-20 Pintura Blanco Italia

Rendimiento Aprox. / Average Usage

- 1 Cartucho 8 Paneles
- 1 Spray 10 Paneles

Precio / Price

-

Complementos opcionales para la instalación / Optional materials for installation



- MSA-3 Masilla Pegado

Rendimiento Aprox. / Average Usage

- 1 Cartucho 4 Paneles

Precio / Price

-

PRODUCTO PRODUCT	COD.	DESCRIPCIÓN DESCRIPTION				PR	€/unidad
PR	LF-472	Panel Capitone Negro	PR: 5-6 kg	PR: 5 un	PR: 60 un	-	-

Complementos necesarios para la instalación / Necessary materials for installation



- MSA-60 Masilla Juntas Antracita
- PTX-29 Pintura Negro

Rendimiento Aprox. / Average Usage

- 1 Cartucho 8 Paneles
- 1 Spray 10 Paneles

Precio / Price

-

Complementos opcionales para la instalación / Optional materials for installation



- MSA-3 Masilla Pegado

Rendimiento Aprox. / Average Usage

- 1 Cartucho 4 Paneles

Precio / Price

-

LIFESTYLE

Lifestyle SYMPHONY®

(2014 Patented Design©)

PANELPIEDRA®

PR



PR LF-610 Blanco Italia



PR LF-610 Blanco Italia



Lifestyle SYMPHONY

ACABADOS / FINISHES



LF-610

Blanco Italia / Italian White

MEDIDAS / MEASUREMENTS

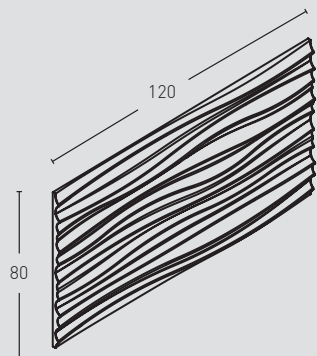

1,5 mín.
5,5 máx.



0,72 m²

PRODUCTO PRODUCT	COD.	DESCRIPCIÓN DESCRIPTION	KG			PR	€/unidad
PR	LF-610	Panel Symphony Blanco Italia	PR: 7-8 kg	PR: 2 un	PR: 24 un	-	-
Complementos necesarios para la instalación / Necessary materials for installation				Rendimiento Aprox. / Average Usage		Precio / Price	
	<input type="checkbox"/>	MSA-70 Masilla Juntas Blanco Italia	1 Cartucho 4 Paneles		-		-
	<input type="checkbox"/>	PTX-20 Pintura Blanco Italia	1 Spray 6 Paneles		-		-
Complementos opcionales para la instalación / Optional materials for installation				Rendimiento Aprox. / Average Usage		Precio / Price	
	<input type="checkbox"/>	MSA-3 Masilla Pegado	1 Cartucho 3 - 4 Paneles		-		-

Lifestyle ELEGANCE[®]

(2018 Patented Design©)

PANELPIEDRA[®]

PR



PR LF-600 Blanco Italia



PR LF-600 Blanco Italia

PR LF-600 Blanco Italia



Lifestyle ELEGANCE

ACABADOS / FINISHES

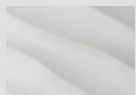

LF-600

Blanco Italia /
Italian White

MEDIDAS / MEASUREMENTS

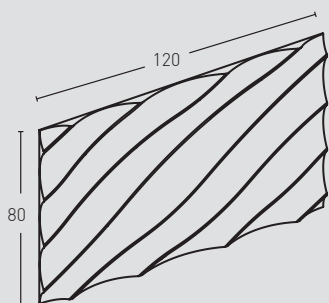

1,5 mín.
5,5 máx.



0,72 m²

PRODUCTO PRODUCT	COD.	DESCRIPCIÓN DESCRIPTION	KG			PR	€/unidad
PR	LF-600	Panel Elegance Blanco Italia	PR: 7-8 kg	PR: 2 un	PR: 24 un	-	-
Complementos necesarios para la instalación / Necessary materials for installation				Rendimiento Aprox. / Average Usage		Precio / Price	
	<input type="checkbox"/>	MSA-70 Masilla Juntas Blanco Italia	1 Cartucho 4 Paneles		-		-
	<input type="checkbox"/>	PTX-20 Pintura Blanco Italia	1 Spray 6 Paneles		-		-
Complementos opcionales para la instalación / Optional materials for installation				Rendimiento Aprox. / Average Usage		Precio / Price	
	<input type="checkbox"/>	MSA-3 Masilla Pegado	1 Cartucho 3 - 4 Paneles		-		-

Lifestyle
ESSENCE[®]

(2013 Patented Design©)

PANELPIEDRA[®]

PR



PR LF-660 Blanco Italia



PR LF-660 Blanco Italia



PR LF-660 Blanco Italia

218 PANELPIEDRA

Lifestyle ESSENCE

ACABADOS / FINISHES



LF-660
Blanco Italia / Italian White

MEDIDAS / MEASUREMENTS

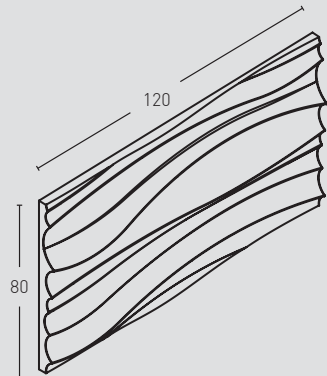

1,5 mín.
5,5 máx.



0,72 m²

PRODUCTO PRODUCT	COD.	DESCRIPCIÓN DESCRIPTION	KG			PR	€/unidad
PR	LF-660	Panel Essence Blanco Italia	PR: 7-8 kg	PR: 2 un	PR: 24 un	-	-
Complementos necesarios para la instalación / Necessary materials for installation				Rendimiento Aprox. / Average Usage		Precio / Price	
	<input type="checkbox"/>	MSA-70 Masilla Juntas Blanco Italia	1 Cartucho 4 Paneles		-		
	<input type="checkbox"/>	PTX-20 Pintura Blanco Italia	1 Spray 6 Paneles		-		
Complementos opcionales para la instalación / Optional materials for installation				Rendimiento Aprox. / Average Usage		Precio / Price	
	<input type="checkbox"/>	MSA-3 Masilla Pegado	1 Cartucho 3 - 4 Paneles		-		

Lifestyle
GRAN
GEOMÉTRICO®

(2014 Patented Design©)

PANELPIEDRA®

PR



PR LF-681 Negro



PR LF-681 Negro

PR LF-681 Negro

Lifestyle GRAN GEOMÉTRICO

ACABADOS / FINISHES



LF-680

Blanco Italia /
Italian White

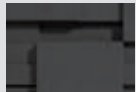

LF-681

Negro /
Black

MEDIDAS / MEASUREMENTS

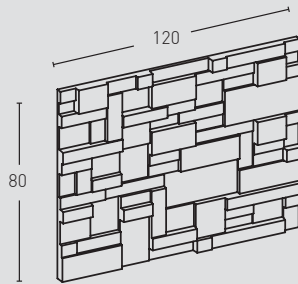

1,5 mín.
5,5 máx.



0,72 m²

PRODUCTO PRODUCT	COD.	DESCRIPCIÓN DESCRIPTION	KG			PR	€/unidad
PR	LF-680	Panel Gran Geométrico Blanco Italia	PR: 7-8 kg	PR: 2 un	PR: 24 un	-	-

Complementos necesarios para la instalación / Necessary materials for installation **Rendimiento Aprox. / Average Usage** **Precio / Price**

	<input type="checkbox"/> MSA-70 Masilla Juntas Blanco Italia	1 Cartucho 4 Paneles	-
	<input type="checkbox"/> PTX-20 Pintura Blanco Italia	1 Spray 6 Paneles	-

Complementos opcionales para la instalación / Optional materials for installation **Rendimiento Aprox. / Average Usage** **Precio / Price**

	<input type="checkbox"/> MSA-3 Masilla Pegado	1 Cartucho 3 - 4 Paneles	-
--	---	--------------------------	---

PRODUCTO PRODUCT	COD.	DESCRIPCIÓN DESCRIPTION	KG			PR	€/unidad
PR	LF-681	Panel Gran Geométrico Negro	PR: --	PR: 2 un	PR: 24 un	-	-

Complementos necesarios para la instalación / Necessary materials for installation **Rendimiento Aprox. / Average Usage** **Precio / Price**

	<input checked="" type="checkbox"/> MSA-60 Masilla Juntas Antracita	1 Cartucho 4 Paneles	-
	<input checked="" type="checkbox"/> PTX-29 Pintura Negro	1 Spray 6 Paneles	-

Complementos opcionales para la instalación / Optional materials for installation **Rendimiento Aprox. / Average Usage** **Precio / Price**

	<input type="checkbox"/> MSA-3 Masilla Pegado	1 Cartucho 3 - 4 Paneles	-
--	---	--------------------------	---

Lifestyle DELPHI®

(2014 Patented Design©)

PANELPIEDRA®

PR



PR LF-641 Blanco Italia



PR LF-641 Negro



Lifestyle DELPHI

ACABADOS / FINISHES



LF-640
Blanco Italia / Italian White

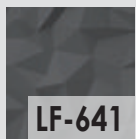

LF-641
Negro / Black

MEDIDAS / MEASUREMENTS

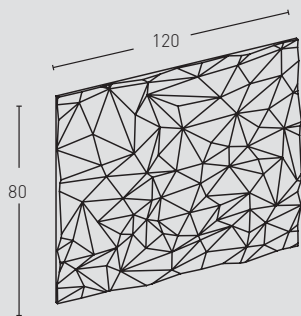

1,5 mín.
5,5 máx.



0,72 m²

PRODUCTO PRODUCT	COD.	DESCRIPCIÓN DESCRIPTION				PR	€/unidad
PR	LF-640	Panel Delphi Blanco Italia	PR: 7-8 kg	PR: 2 un	PR: 24 un	-	-

Complementos necesarios para la instalación / Necessary materials for installation

Complementos necesarios para la instalación / Necessary materials for installation	Rendimiento Aprox. / Average Usage	Precio / Price
MSA-70 Masilla Juntas Blanco Italia	1 Cartucho 4 Paneles	-
PTX-20 Pintura Blanco Italia	1 Spray 6 Paneles	-

Complementos opcionales para la instalación / Optional materials for installation

Complementos opcionales para la instalación / Optional materials for installation	Rendimiento Aprox. / Average Usage	Precio / Price
MSA-3 Masilla Pegado	1 Cartucho 3 - 4 Paneles	-

PRODUCTO PRODUCT	COD.	DESCRIPCIÓN DESCRIPTION				PR	€/unidad
PR	LF-641	Panel Delphi Negro	PR: --	PR: 2 un	PR: 24 un	-	-

Complementos necesarios para la instalación / Necessary materials for installation

Complementos necesarios para la instalación / Necessary materials for installation	Rendimiento Aprox. / Average Usage	Precio / Price
MSA-60 Masilla Juntas Antracita	1 Cartucho 4 Paneles	-
PTX-29 Pintura Negro	1 Spray 6 Paneles	-

Complementos opcionales para la instalación / Optional materials for installation

Complementos opcionales para la instalación / Optional materials for installation	Rendimiento Aprox. / Average Usage	Precio / Price
MSA-3 Masilla Pegado	1 Cartucho 3 - 4 Paneles	-



CLASSIC[®]

Collection

CLASSIC[®]

Collection



PIZARRA / 232-235



LAJA GALLEGA / 236-241



LAJA FINA / 242-243



PIZARRA ANDES / 244-247



PIZARRA NEPAL / 248-251



PIZARRA MONTBLANC / 252-255



PIZARRA ALPES / 256-259



BAZTÁN / 260-263



LIÉBANA / 264-267

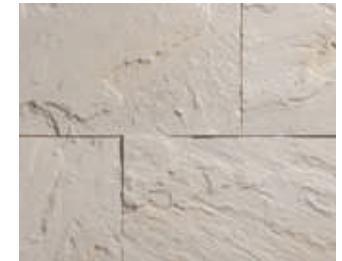

TÍBET / 268-271



LASTRA / 272-275



SILLARES / 276-279



SILLAREJOS / 280-283

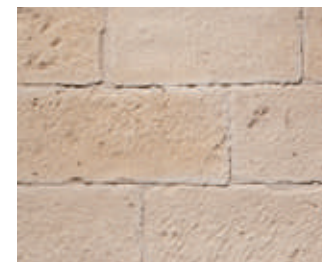

SILLAR PICADO / 284-285



SILLAR VIEJO / 286-287

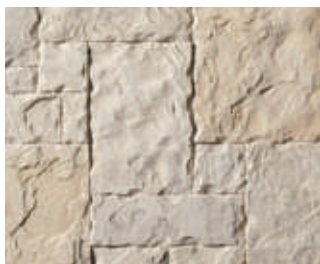

**MAMPOSTERÍA REGULAR /
288-291**

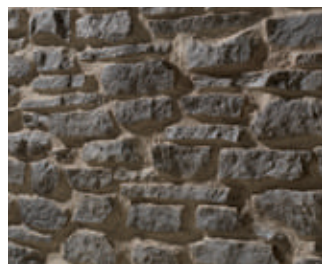

PIEDRA ÁRIDA / 292-295



**MAMPOSTERÍA RENACIMIENTO /
296-299**



PIEDRA DE ADOBE / 300-303



PIRINEOS / 304-307

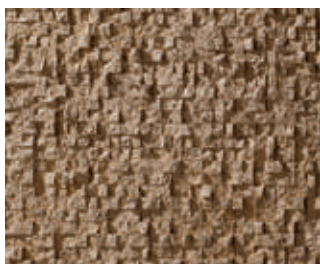

CUBIC / 308-311



GRAN CUBIC / 312-315

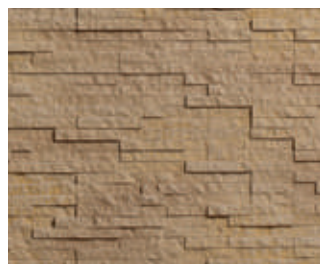

INSPIRATION / 316-319



DELUXE / 320-323



PREMIER / 324-327



EMPHASIS / 328-331



CONCEPT / 332-335

Classic PIZARRA

PANELPIEDRA®

PR



PR 25 Blanco Italia



PR 24 Antracita

Classic PIZARRA

ACABADOS / FINISHES

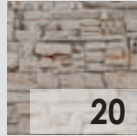

20

Blanco Arena /
Sandy White

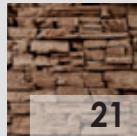

21

Marrón /
Brown

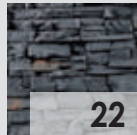

22

Gris /
Grey

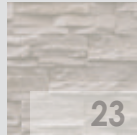

23

Marrón Tierra /
Sandy Brown

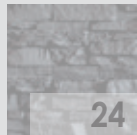

24

Antracita /
Anthracite

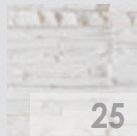

25

Blanco Italia /
Italia White

MEDIDAS / MEASUREMENTS

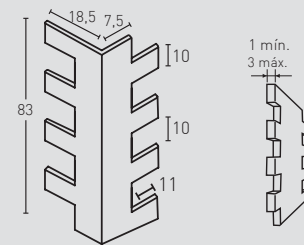
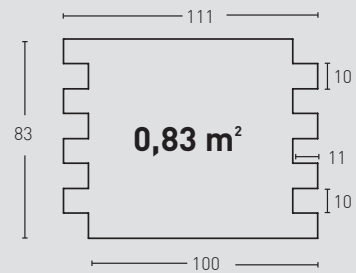

PRODUCTO PRODUCT	COD.	DESCRIPCIÓN DESCRIPTION	KG			PR
PR	20 20-E	Panel Pizarra Blanco Arena Ángulo Pizarra Blanco Arena	PR: 6-7 kg PR: 2-3 kg	PR: 3un PR: 1un	PR: 36 un PR: 31un	€/unidad - -

Complementos necesarios para la instalación / Necessary materials for installation

Complementos necesarios para la instalación / Necessary materials for installation	Rendimiento Aprox. / Average Usage	Precio / Price
MSA-10 Masilla Juntas Beige PTX-01 Pintura Beige Pizarra PTE-22 Pintura Envejecido Gris	1 Cartucho 2-3 Paneles 1 Spray 8 Paneles 1 Spray 15 Paneles	- - -

Complementos opcionales para la instalación / Optional materials for installation

Complementos opcionales para la instalación / Optional materials for installation	Rendimiento Aprox. / Average Usage	Precio / Price
MSA-3 Masilla de Pegado PTE-24 Pintura Envejecido Rojo PTE-21 Pintura Envejecido Marrón	1 Cartucho 4-5 Paneles 1 Spray 15 Paneles 1 Spray 15 Paneles	- - -

PRODUCTO PRODUCT	COD.	DESCRIPCIÓN DESCRIPTION	KG			PR
PR	21 21-E	Panel Pizarra Marrón Ángulo Pizarra Marrón	PR: 6-7 kg PR: 2-3 kg	PR: 3un PR: 1un	PR: 36 un PR: 31un	€/unidad - -

Complementos necesarios para la instalación / Necessary materials for installation

Complementos necesarios para la instalación / Necessary materials for installation	Rendimiento Aprox. / Average Usage	Precio / Price
MSA-70 Masilla Blanco Italia PTX-09 Pintura Marrón PTE-35 Pintura Envejecido Óxido	1 Cartucho 2-3 Paneles 1 Spray 8 Paneles 1 Spray 15 Paneles	- - -

Complementos opcionales para la instalación / Optional materials for installation

Complementos opcionales para la instalación / Optional materials for installation	Rendimiento Aprox. / Average Usage	Precio / Price
MSA-3 Masilla de Pegado PTE-37 Pintura Envejecido Marrón Oscuro	1 Cartucho 4-5 Paneles 1 Spray 15 Paneles	- -

PRODUCTO PRODUCT	COD.	DESCRIPCIÓN DESCRIPTION	KG			PR
PR	22 22-E	Panel Pizarra Gris Ángulo Pizarra Gris	PR: 6-7 kg PR: 2-3 kg	PR: 3un PR: 1un	PR: 36 un PR: 31un	€/unidad - -

Complementos necesarios para la instalación / Necessary materials for installation

Complementos necesarios para la instalación / Necessary materials for installation	Rendimiento Aprox. / Average Usage	Precio / Price
MSA-30 Masilla Juntas Gris PTX-03 Pintura Gris Comp-09 Esparto Rojo	1 Cartucho 2-3 Paneles 1 Spray 8 Paneles 1 Pliego 15 Paneles	- - -

Complementos opcionales para la instalación / Optional materials for installation

Complementos opcionales para la instalación / Optional materials for installation	Rendimiento Aprox. / Average Usage	Precio / Price
MSA-3 Masilla de Pegado PTE-24 Pintura Envejecido Rojo PTE-21 Pintura Envejecido Marrón	1 Cartucho 4-5 Paneles 1 Spray 15 Paneles 1 Spray 15 Paneles	- - -

Las medidas pueden variar +/-1cm / Measurements may vary +/-1cm

Classic PIZARRA

ACABADOS / FINISHES

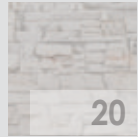

20
Blanco Arena /
Sandy White

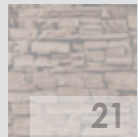

21
Marrón /
Brown

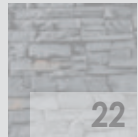

22
Gris /
Grey

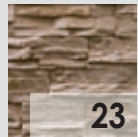

23
Marrón Tierra /
Sandy Brown

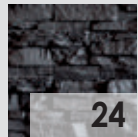

24
Antracita /
Anthracite

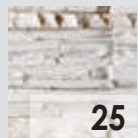

25
Blanco Italia /
Italia White

MEDIDAS / MEASUREMENTS

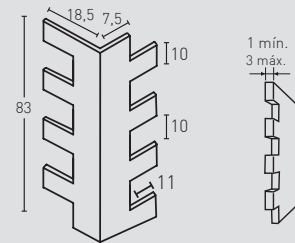
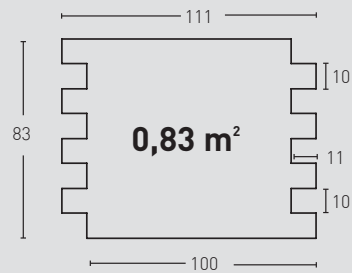

Las medidas pueden variar +/- 1cm / Measurements may vary +/- 1cm

PRODUCTO PRODUCT	COD.	DESCRIPCIÓN DESCRIPTION	KG			PR	€/unidad
PR	23 23-E	Panel Pizarra Marrón Arena	PR: 6-7 kg	PR: 3un	PR: 36 un	-	-
		Ángulo Pizarra Marrón Arena	PR: 2-3 kg	PR: 1un	PR: 31un	-	-

Complementos necesarios para la instalación / Necessary materials for installation

Complementos necesarios para la instalación / Necessary materials for installation	Rendimiento Aprox. / Average Usage	Precio / Price
● MSA-20 Masilla Juntas Beige	1 Cartucho 2-3 Paneles	-
● PTX-02 Pintura Beige Juntas	1 Spray 8 Paneles	-
○ PTE-33 Pintura Envejecido Caleado + Comp6 (Bote)	1 Spray 15 Paneles	-

Complementos opcionales para la instalación / Optional materials for installation

Complementos opcionales para la instalación / Optional materials for installation	Rendimiento Aprox. / Average Usage	Precio / Price
○ MSA-3 Masilla de Pegado	1 Cartucho 4-5 Paneles	-
● PTE-31 Pintura Envejecido Piel	1 Spray 15 Paneles	-
● PTE-36 Pintura Envejecido Rojizo	1 Spray 15 Paneles	-

PRODUCTO PRODUCT	COD.	DESCRIPCIÓN DESCRIPTION	KG			PR	€/unidad
PR	24 24-E	Panel Pizarra Antracita	PR: 6-7 kg	PR: 3un	PR: 36 un	-	-
		Ángulo Pizarra Antracita	PR: 2-3 kg	PR: 1un	PR: 31un	-	-

Complementos necesarios para la instalación / Necessary materials for installation

Complementos necesarios para la instalación / Necessary materials for installation	Rendimiento Aprox. / Average Usage	Precio / Price
● MSA-60 Masilla Juntas Antracita	1 Cartucho 2 - 3 Paneles	-
● PTX-19 Pintura Antracita	1 Spray 6 Paneles	-

Complementos opcionales para la instalación / Optional materials for installation

Complementos opcionales para la instalación / Optional materials for installation	Rendimiento Aprox. / Average Usage	Precio / Price
○ MSA-3 Masilla de Pegado	1 Cartucho 4-5 Paneles	-

PRODUCTO PRODUCT	COD.	DESCRIPCIÓN DESCRIPTION	KG			PR	€/unidad
PR	25 25-E	Panel Pizarra Blanco Italia	PR: 6-7 kg	PR: 3un	PR: 36 un	-	-
		Ángulo Pizarra Blanco Italia	PR: 2-3 kg	PR: 1un	PR: 31un	-	-

Complementos necesarios para la instalación / Necessary materials for installation

Complementos necesarios para la instalación / Necessary materials for installation	Rendimiento Aprox. / Average Usage	Precio / Price
○ MSA-70 Masilla Juntas Blanco Italia	1 Cartucho 2-3 Paneles	-
○ PTX-20 Pintura Blanco Italia	1 Spray 8 Paneles	-
● PTE-22 Pintura Envejecido Gris	1 Spray 15 Paneles	-

Complementos opcionales para la instalación / Optional materials for installation

Complementos opcionales para la instalación / Optional materials for installation	Rendimiento Aprox. / Average Usage	Precio / Price
○ MSA-3 Masilla de Pegado	1 Cartucho 4-5 Paneles	-
● PTE-24 Pintura Envejecido Rojo	1 Spray 15 Paneles	-
● PTE-21 Pintura Envejecido Marrón	1 Spray 15 Paneles	-

Classic
LAJA
GALLEGA

PANELPIEDRA®

PR



PR 81 Gris



PR 80 Blanco Arena

Classic LAJA GALLEGA

ACABADOS / FINISHES

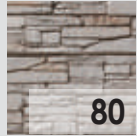

80

Blanco Arena /
Sandy White

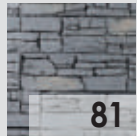

81

Gris /
Grey

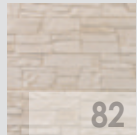

82

Marrón Arena /
Sandy Brown

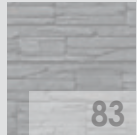

83

Antracita /
Anthracite

MEDIDAS / MEASUREMENTS

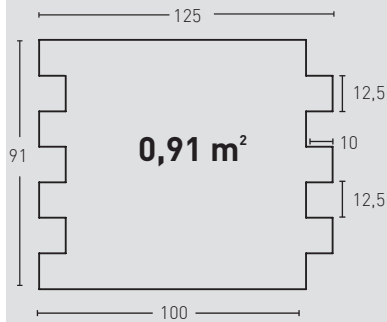

1 mín.
3 máx.

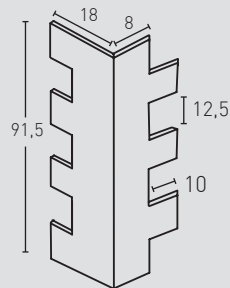

PRODUCTO PRODUCT	COD.	DESCRIPCIÓN DESCRIPTION				PR	€/unidad
PR	80	Panel Laja Gallega Blanco Arena	PR: 6-7 kg	PR: 4 un	PR: 48 un	-	-
	80-E	Áng. Laja Gallega Blanco Arena	PR: 2-3 kg	PR: 4 un	PR: 60 un	-	-

Complementos necesarios para la instalación / Necessary materials for installation

Complementos necesarios para la instalación / Necessary materials for installation	Rendimiento Aprox. / Average Usage	Precio / Price
MSA-10 Masilla Juntas Beige	1 Cartucho 3 Paneles	-
PTX-01 Pintura Beige Pizarra	1 Spray 8 Paneles	-
PTE-22 Pintura Envejecido Gris	1 Spray 15 Paneles	-

Complementos opcionales para la instalación / Optional materials for installation

Complementos opcionales para la instalación / Optional materials for installation	Rendimiento Aprox. / Average Usage	Precio / Price
MSA-3 Masilla de Pegado	1 Cartucho 4-5 Paneles	-
PTE-24 Pintura Envejecido Rojo	1 Spray 15 Paneles	-
PTE-21 Pintura Envejecido Marrón	1 Spray 15 Paneles	-

PRODUCTO PRODUCT	COD.	DESCRIPCIÓN DESCRIPTION				PR	€/unidad
PR	81	Panel Laja Gallega Gris	PR: 6-7 kg	PR: 4 un	PR: 48 un	-	-
	81-E	Ángulo Laja Gallega Gris	PR: 2-3 kg	PR: 4 un	PR: 60 un	-	-

Complementos necesarios para la instalación / Necessary materials for installation

Complementos necesarios para la instalación / Necessary materials for installation	Rendimiento Aprox. / Average Usage	Precio / Price
MSA-30 Masilla Juntas Gris	1 Cartucho 3 Paneles	-
PTX-03 Pintura Gris	1 Spray 8 Paneles	-
Comp-09 Esparto Rojo	1 Pliego 15 Paneles	-

Complementos opcionales para la instalación / Optional materials for installation

Complementos opcionales para la instalación / Optional materials for installation	Rendimiento Aprox. / Average Usage	Precio / Price
MSA-3 Masilla de Pegado	1 Cartucho 4-5 Paneles	-
PTE-24 Pintura Envejecido Rojo	1 Spray 15 Paneles	-
PTE-21 Pintura Envejecido Marrón	1 Spray 15 Paneles	-

Las medidas pueden variar +/-1cm / Measurements may vary +/-1cm

Classic LAJA GALLEGA

ACABADOS / FINISHES

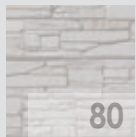

80
Blanco Arena /
Sandy White

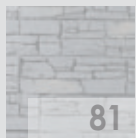

81
Gris /
Grey

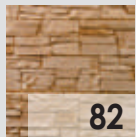

82
Marrón Arena /
Sandy Brown

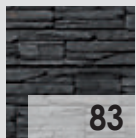

83
Antracita /
Anthracite

MEDIDAS / MEASUREMENTS

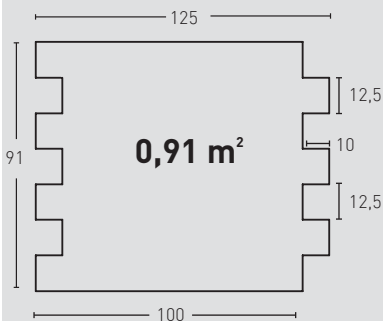

1 mín.
3 máx.

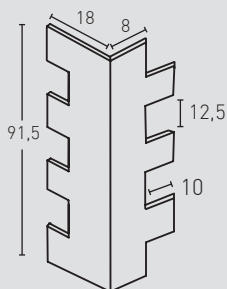

PRODUCTO PRODUCT	COD.	DESCRIPCIÓN DESCRIPTION	KG			PR	€/unidad
PR	82	Panel Laja Gallega Marrón Arena	PR: 6-7 kg	PR: 4 un	PR: 48 un	-	-
	82-E	Áng. Laja Gallega Marrón Arena	PR: 2-3 kg	PR: 4 un	PR: 60 un	-	-

Complementos necesarios para la instalación / Necessary materials for installation

		Rendimiento Aprox. / Average Usage	Precio / Price
	● MSA-20 Masilla Juntas Beige	1 Cartucho 3 Paneles	-
	● PTX-02 Pintura Beige Juntas	1 Spray 8 Paneles	-
	○ PTE-33 Pintura Envejecido Caleado + Comp6 (Bote)	1 Spray 15 Paneles	-

Complementos opcionales para la instalación / Optional materials for installation

		Rendimiento Aprox. / Average Usage	Precio / Price
	○ MSA-3 Masilla de Pegado	1 Cartucho 4-5 Paneles	-
	● PTE-31 Pintura Envejecido Piel	1 Spray 15 Paneles	-
	● PTE-36 Pintura Envejecido Rojizo	1 Spray 15 Paneles	-

PRODUCTO PRODUCT	COD.	DESCRIPCIÓN DESCRIPTION	KG			PR	€/unidad
PR	83	Panel Laja Gallega Antracita	PR: 6-7 kg	PR: 3 un	PR: 36 un	-	-
	83-E	Ángulo Laja Gallega Antracita	PR: 2-3 kg	PR: 1 un	PR: 31 un	-	-

Complementos necesarios para la instalación / Necessary materials for installation

		Rendimiento Aprox. / Average Usage	Precio / Price
	● MSA-60 Masilla Juntas Antracita	1 Cartucho 3 Paneles	-
	● PTX-19 Pintura Antracita	1 Spray 6 Paneles	-

Complementos opcionales para la instalación / Optional materials for installation

		Rendimiento Aprox. / Average Usage	Precio / Price
	○ MSA-3 Masilla de Pegado	1 Cartucho 4-5 Paneles	-

Classic LAJA FINA

PANELPIEDRA®

PR



PR 165 Gris Claro Combinado



PR 164 Blanco Italia

Classic LAJA FINA

ACABADOS / FINISHES

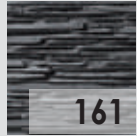

161
Gris / Grey

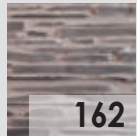

162
Gris Oscuro Combinado / Two Dark Tone



163
Antracita / Anthracite



164
Blanco Italia / Italian White

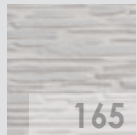

165
Gris Claro Combinado / Two Light Tone

MEDIDAS / MEASUREMENTS

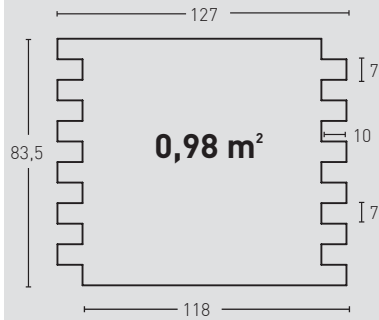

1 mín.
3 máx.

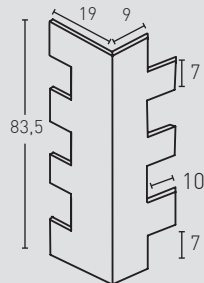

PRODUCTO PRODUCT	COD.	DESCRIPCIÓN DESCRIPTION				PR
PR	161 161-E	Panel Laja Fina Gris Ángulo Laja Fina Gris	PR: 6-7 kg	PR: 4 un	PR: 48 un	€/unidad
			PR: 2-3 kg	PR: 2 un	PR: 30 un	-

Complementos necesarios para la instalación / Necessary materials for installation

Complementos necesarios para la instalación / Necessary materials for installation	Rendimiento Aprox. / Average Usage	Precio / Price
● MSA-30 Masilla Juntas Gris	1 Cartucho 3 Paneles	-
● PTX-03 Pintura Gris	1 Spray 8 Paneles	-
○ PTE-23 Pintura Envejecido Blanco	1 Spray 15 Paneles	-

Complementos opcionales para la instalación / Optional materials for installation

Complementos opcionales para la instalación / Optional materials for installation	Rendimiento Aprox. / Average Usage	Precio / Price
○ MSA-3 Masilla de Pegado	1 Cartucho 4-5 Paneles	-

PRODUCTO PRODUCT	COD.	DESCRIPCIÓN DESCRIPTION				PR
PR	162 162-E	Panel Laja Fina Gris oscuro Comb. Áng. Laja Fina Gris oscuro Comb.	PR: 6-7 kg	PR: 4 un	PR: 48 un	€/unidad
			PR: 2-3 kg	PR: 2 un	PR: 30 un	-

Complementos necesarios para la instalación / Necessary materials for installation

Complementos necesarios para la instalación / Necessary materials for installation	Rendimiento Aprox. / Average Usage	Precio / Price
● MSA-10 Masilla Juntas Beige	1 Cartucho 2-3 Paneles	-
● PTX-01 Pintura Beige Pizarra	1 Spray 8 Paneles	-
● PTE-21 Pintura Envejecido Marrón	1 Spray 15 Paneles	-

Complementos opcionales para la instalación / Optional materials for installation

Complementos opcionales para la instalación / Optional materials for installation	Rendimiento Aprox. / Average Usage	Precio / Price
○ MSA-3 Masilla de Pegado	1 Cartucho 4-5 Paneles	-
● PTE-36 Pintura Envejecido Rojizo	1 Spray 15 Paneles	-
● PTE-37 Pintura Envejecido Marrón Oscuro	1 Spray 15 Paneles	-

PRODUCTO PRODUCT	COD.	DESCRIPCIÓN DESCRIPTION				PR
PR	163 163-E	Panel Laja Fina Antracita Ángulo Laja Fina Antracita	PR: 6-7 kg	PR: 4 un	PR: 48 un	€/unidad
			PR: 2-3 kg	PR: 2 un	PR: 30 un	-

Complementos necesarios para la instalación / Necessary materials for installation

Complementos necesarios para la instalación / Necessary materials for installation	Rendimiento Aprox. / Average Usage	Precio / Price
● MSA-60 Masilla Juntas Antracita	1 Cartucho 2-3 Paneles	-
● PTX-19 Pintura Antracita	1 Spray 8 Paneles	-

Complementos opcionales para la instalación / Optional materials for installation

Complementos opcionales para la instalación / Optional materials for installation	Rendimiento Aprox. / Average Usage	Precio / Price
○ MSA-3 Masilla de Pegado	1 Cartucho 4-5 Paneles	-

Las medidas pueden variar +/-1cm / Measurements may vary +/-1cm

Classic LAJA FINA

ACABADOS / FINISHES



161
Gris / Grey



162
Gris Oscuro Combinado / Two Dark Tone



163
Antracita / Anthracite



164
Blanco Italia / Italian White

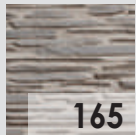

165
Gris Claro Combinado / Two Light Tone

MEDIDAS / MEASUREMENTS

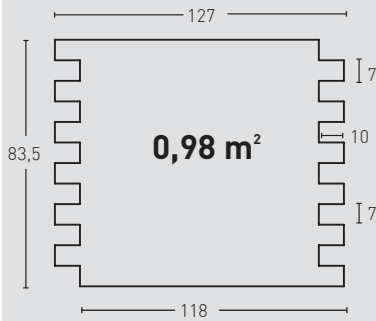

1 mín.
3 máx.

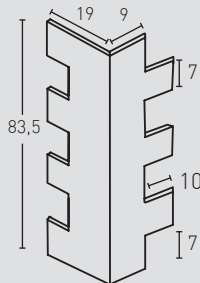

PRODUCTO PRODUCT	COD.	DESCRIPCIÓN DESCRIPTION				PR	€/unidad
PR	164 164-E	Panel Laja Fina Blanco Italia Ángulo Laja Fina Blanco Italia	PR: 6-7 kg PR: 2-3 kg	PR: 4 un PR: 2 un	PR: 48 un PR: 30 un	- -	- -

Complementos necesarios para la instalación / Necessary materials for installation

Complementos necesarios para la instalación / Necessary materials for installation	Rendimiento Aprox. / Average Usage	Precio / Price
MSA-70 Masilla Juntas Beige	1 Cartucho 2-3 Paneles	-
PTX-20 Pintura Blanco Italia	1 Spray 8 Paneles	-

Complementos opcionales para la instalación / Optional materials for installation

Complementos opcionales para la instalación / Optional materials for installation	Rendimiento Aprox. / Average Usage	Precio / Price
MSA-3 Masilla de Pegado	1 Cartucho 4-5 Paneles	-

PRODUCTO PRODUCT	COD.	DESCRIPCIÓN DESCRIPTION				PR	€/unidad
PR	165 165-E	Panel Laja Fina Gris Claro Comb. Ángulo Laja Fina Gris Claro Comb.	PR: 6-7 kg PR: 2-3 kg	PR: 4 un PR: 2 un	PR: 48 un PR: 30 un	- -	- -

Complementos necesarios para la instalación / Necessary materials for installation

Complementos necesarios para la instalación / Necessary materials for installation	Rendimiento Aprox. / Average Usage	Precio / Price
MSA-10 Masilla Juntas Beige	1 Cartucho 2-3 Paneles	-
PTX-01 Pintura Beige Pizarra	1 Spray 8 Paneles	-
PTE-21 Pintura Envejecido Marrón	1 Spray 15 Paneles	-

Complementos opcionales para la instalación / Optional materials for installation

Complementos opcionales para la instalación / Optional materials for installation	Rendimiento Aprox. / Average Usage	Precio / Price
MSA-3 Masilla de Pegado	1 Cartucho 4-5 Paneles	-
PTX-53 Pintura Gris Claro	1 Spray 15 Paneles	-
PTX-37 Pintura Gris II	1 Spray 15 Paneles	-

Classic PIZARRA ANDES

PANELPIEDRA®

PR

HD



PR 413 Marrón Arena



PR 415 Blanco Italia

Classic PIZARRA ANDES

ACABADOS / FINISHES

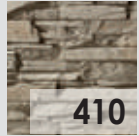

410
Blanco Arena /
Sandy White

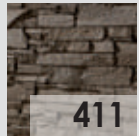

411
Marrón /
Brown

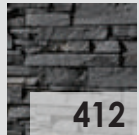

412
Gris /
Grey

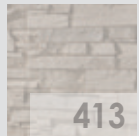

413
Marrón Arena /
Sandy Brown

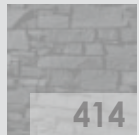

414
Antracita /
Anthracite

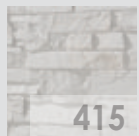

415
Blanco Italia /
Italia White

MEDIDAS / MEASUREMENTS

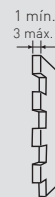
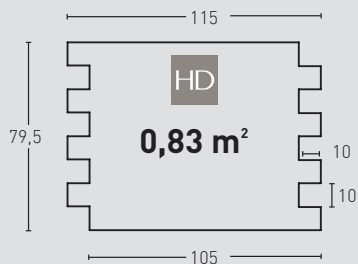
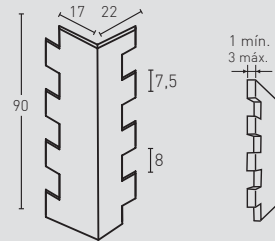
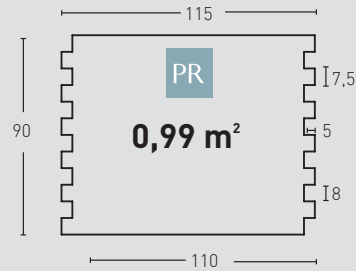
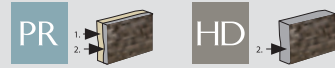

Las medidas pueden variar +/-1cm / Measurements may vary +/-1cm

PRODUCTO PRODUCT	COD.	DESCRIPCIÓN DESCRIPTION	KG			PR	HD
PR HD	410 410-E	Panel Piz. Andes Blanco Arena Ángulo Piz. Andes Blanco Arena	PR:7-8kg / HD:15-20kg PR: 2-3 kg / HD: --	PR:4un / HD:25un PR:1un / HD: --	PR:48un / HD:25un PR:60un / HD: --	-	-
						€/unidad - - - *	

Complementos necesarios para la instalación / Necessary materials for installation			Rendimiento Aprox. / Average Usage		Precio / Price	
	● MSA-10 Masilla Juntas Beige		1 Cartucho 2-3 Paneles	-		
	● PTX-01 Pintura Beige Pizarra		1 Spray 8 Paneles	-		
	● PTE-22 Pintura Envejecido Gris		1 Spray 15 Paneles	-		

Complementos opcionales para la instalación / Optional materials for installation			Rendimiento Aprox. / Average Usage		Precio / Price	
	○ MSA-3 Masilla de Pegado		1 Cartucho 4-5 Paneles	-		
	● PTE-24 Pintura Envejecido Rojo		1 Spray 15 Paneles	-		
	● PTE-21 Pintura Envejecido Marrón Oscuro		1 Spray 15 Paneles	-		

PRODUCTO PRODUCT	COD.	DESCRIPCIÓN DESCRIPTION	KG			PR	HD
PR HD	411 411-E	Panel Pizarra Andes Marrón Ángulo Pizarra Andes Marrón	PR:7-8kg / HD:15-20kg PR: 2-3 kg / HD: --	PR:4un / HD:25un PR:1un / HD: --	PR:48un / HD:25un PR:60un / HD: --	-	-
						€/unidad - - - *	

Complementos necesarios para la instalación / Necessary materials for installation			Rendimiento Aprox. / Average Usage		Precio / Price	
	○ MSA-70 Masilla Blanco Italia		1 Cartucho 2-3 Paneles	-		
	● PTX-09 Pintura Marrón		1 Spray 8 Paneles	-		
	● PTE-35 Pintura Envejecido Óxido		1 Spray 15 Paneles	-		

Complementos opcionales para la instalación / Optional materials for installation			Rendimiento Aprox. / Average Usage		Precio / Price	
	○ MSA-3 Masilla de Pegado		1 Cartucho 4-5 Paneles	-		
	● PTE-37 Pintura Envejecido Marrón Oscuro		1 Spray 15 Paneles	-		

PRODUCTO PRODUCT	COD.	DESCRIPCIÓN DESCRIPTION	KG			PR	HD
PR HD	412 412-E	Panel Pizarra Andes Gris Ángulo Pizarra Andes Gris	PR:7-8kg / HD:15-20kg PR: 2-3 kg / HD: --	PR:4un / HD:25un PR:1un / HD: --	PR:48un / HD:25un PR:60un / HD: --	-	-
						€/unidad - - - *	

Complementos necesarios para la instalación / Necessary materials for installation			Rendimiento Aprox. / Average Usage		Precio / Price	
	● MSA-30 Masilla Juntas Gris		1 Cartucho 2-3 Paneles	-		
	● PTX-03 Pintura Gris		1 Spray 8 Paneles	-		
	● Comp-09 Esparto Rojo		1 Pliego 15 Paneles	-		

Complementos opcionales para la instalación / Optional materials for installation			Rendimiento Aprox. / Average Usage		Precio / Price	
	○ MSA-3 Masilla de Pegado		1 Cartucho 4-5 Paneles	-		
	● PTE-24 Pintura Envejecido Rojo		1 Spray 15 Paneles	-		
	● PTE-21 Pintura Envejecido Marrón		1 Spray 15 Paneles	-		

* Consultar fecha de entrega / Consult delivery date

Classic PIZARRA ANDES

ACABADOS / FINISHES

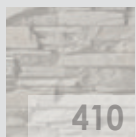

410
Blanco Arena /
Sandy White

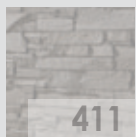

411
Marrón /
Brown

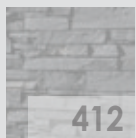

412
Gris /
Grey

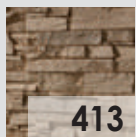

413
Marrón Arena /
Sandy Brown

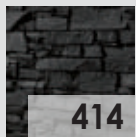

414
Antracita /
Anthracite

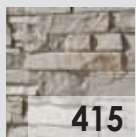

415
Blanco Italia /
Italia White

MEDIDAS / MEASUREMENTS

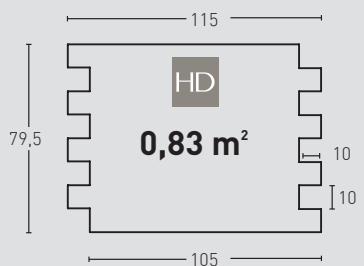
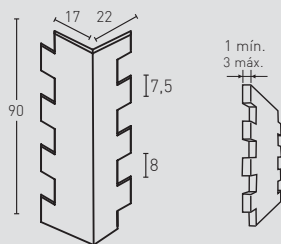
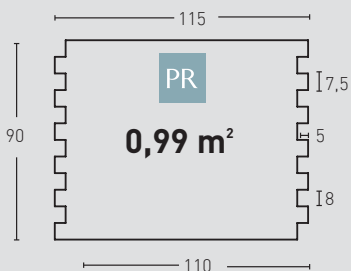

Las medidas pueden variar +/- 1cm / Measurements may vary +/- 1cm

PRODUCTO PRODUCT	COD.	DESCRIPCIÓN DESCRIPTION				PR	HD
PR HD	413 413-E	Panel Piz. Andes Marrón Arena Ángulo Piz. Andes Marrón Arena	PR:7-8kg / HD:15-20kg PR: 2-3 kg	PR:4un / HD:25un PR: 1 un	PR:48un / HD:25un PR: 60 un	-	-
						€/unidad	
						-	*
						-	consultar

Complementos necesarios para la instalación / Necessary materials for installation



- MSA-20 Masilla Juntas Beige
- PTX-02 Pintura Beige Juntas
- PTE-33 Pintura Envejecido Caleado + Comp6 (Bote)

- Rendimiento Aprox. / Average Usage
- 1 Cartucho 2-3 Paneles
 - 1 Spray 8 Paneles
 - 1 Spray 15 Paneles

Precio / Price

Complementos opcionales para la instalación / Optional materials for installation



- MSA-3 Masilla de Pegado
- PTE-31 Pintura Envejecido Piel
- PTE-36 Pintura Envejecido Rojizo

- Rendimiento Aprox. / Average Usage
- 1 Cartucho 4-5 Paneles
 - 1 Spray 15 Paneles
 - 1 Spray 15 Paneles

Precio / Price

PRODUCTO PRODUCT	COD.	DESCRIPCIÓN DESCRIPTION				PR	HD
PR HD	414 414-E	Panel Pizarra Andes Antracita Ángulo Pizarra Andes Antracita	PR:7-8kg / HD:15-20kg PR: 2-3 kg	PR:4un / HD:25un PR: 1 un	PR:48un / HD:25un PR: 60 un	-	-
						€/unidad	
						-	*
						-	consultar

Complementos necesarios para la instalación / Necessary materials for installation



- MSA-60 Masilla Juntas Antracita
- PTX-19 Pintura Antracita

- Rendimiento Aprox. / Average Usage
- 1 Cartucho 2-3 Paneles
 - 1 Spray 6 Paneles

Precio / Price

Complementos opcionales para la instalación / Optional materials for installation



- MSA-3 Masilla de Pegado

- Rendimiento Aprox. / Average Usage
- 1 Cartucho 4-5 Paneles

Precio / Price

PRODUCTO PRODUCT	COD.	DESCRIPCIÓN DESCRIPTION				PR	HD
PR HD	415 415-E	Panel Piz. Andes Blanco Italia Ángulo Piz. Andes Blanco Italia	PR:7-8kg / HD:15-20kg PR: 2-3 kg	PR:4un / HD:25un PR: 1 un	PR:48un / HD:25un PR: 60 un	-	-
						€/unidad	
						-	*
						-	consultar

Complementos necesarios para la instalación / Necessary materials for installation



- MSA-70 Masilla Juntas Blanco Italia
- PTX-20 Pintura Blanco Italia
- PTE-22 Pintura Envejecido Gris

- Rendimiento Aprox. / Average Usage
- 1 Cartucho 2-3 Paneles
 - 1 Spray 8 Paneles
 - 1 Spray 15 Paneles

Precio / Price

Complementos opcionales para la instalación / Optional materials for installation



- MSA-3 Masilla de Pegado
- PTE-24 Pintura Envejecido Rojo
- PTE-21 Pintura Envejecido Marrón

- Rendimiento Aprox. / Average Usage
- 1 Cartucho 4-5 Paneles
 - 1 Spray 15 Paneles
 - 1 Spray 15 Paneles

Precio / Price

* Consultar fecha de entrega / Consult delivery date

Classic PIZARRA NEPAL

PANELPIEDRA®

PR

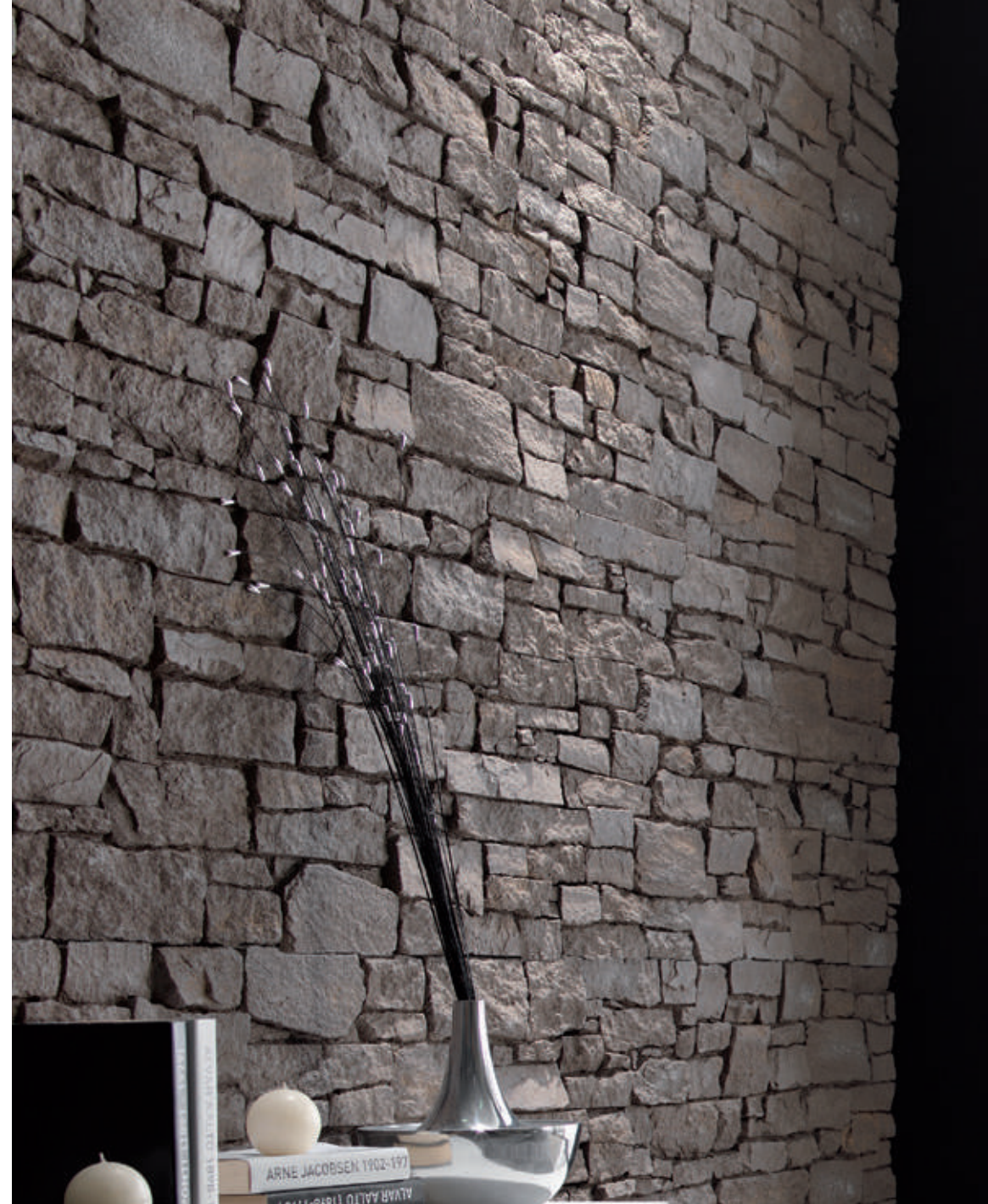

PR 421 Marrón



PR 422 Gris

Classic PIZARRA NEPAL

ACABADOS / FINISHES

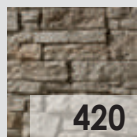

420
Blanco Arena /
Sandy White

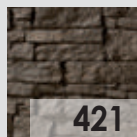

421
Marrón /
Brown

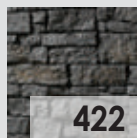

422
Gris /
Grey

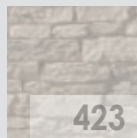

423
Marrón Arena /
Sandy Brown

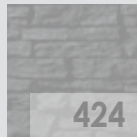

424
Antracita /
Anthracite



425
Blanco Italia /
Italia White

MEDIDAS / MEASUREMENTS

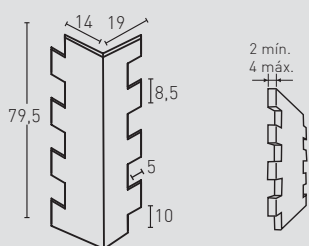
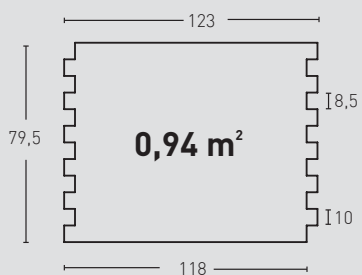

PRODUCTO PRODUCT	COD.	DESCRIPCIÓN DESCRIPTION				PR
PR	420	Panel Piz. Nepal Blanco Arena	PR: 7-8 kg	PR: 3 un	PR: 36 un	€/unidad
	420-E	Ángulo Piz. Nepal Blanco Arena	PR: 2-3 kg	PR: 2 un	PR: 30 un	-
Complementos necesarios para la instalación / Necessary materials for installation			Rendimiento Aprox. / Average Usage		Precio / Price	
	● MSA-10 Masilla Juntas Beige	1 Cartucho 2-3 Paneles	-			
	● PTX-01 Pintura Beige Pizarra	1 Spray 8 Paneles	-			
	● PTE-22 Pintura Envejecido Gris	1 Spray 15 Paneles	-			
Complementos opcionales para la instalación / Optional materials for installation			Rendimiento Aprox. / Average Usage		Precio / Price	
	○ MSA-3 Masilla de Pegado	1 Cartucho 4-5 Paneles	-			
	● PTE-24 Pintura Envejecido Rojo	1 Spray 15 Paneles	-			
	● PTE-21 Pintura Envejecido Marrón	1 Spray 15 Paneles	-			
PRODUCTO PRODUCT	COD.	DESCRIPCIÓN DESCRIPTION				PR
PR	421	Panel Pizarra Nepal Marrón	PR: 7-8 kg	PR: 3 un	PR: 36 un	€/unidad
	421-E	Ángulo Pizarra Nepal Marrón	PR: 2-3 kg	PR: 2 un	PR: 30 un	-
Complementos necesarios para la instalación / Necessary materials for installation			Rendimiento Aprox. / Average Usage		Precio / Price	
	○ MSA-70 Masilla Blanco Italia	1 Cartucho 2-3 Paneles	-			
	● PTX-09 Pintura Marrón	1 Spray 8 Paneles	-			
	● PTE-35 Pintura Envejecido Óxido	1 Spray 15 Paneles	-			
Complementos opcionales para la instalación / Optional materials for installation			Rendimiento Aprox. / Average Usage		Precio / Price	
	○ MSA-3 Masilla de Pegado	1 Cartucho 4-5 Paneles	-			
	● PTE-37 Pintura Envejecido Marrón Oscuro	1 Spray 15 Paneles	-			
PRODUCTO PRODUCT	COD.	DESCRIPCIÓN DESCRIPTION				PR
PR	422	Panel Pizarra Nepal Gris	PR: 7-8 kg	PR: 3 un	PR: 36 un	€/unidad
	422-E	Ángulo Pizarra Nepal Gris	PR: 2-3 kg	PR: 2 un	PR: 30 un	-
Complementos necesarios para la instalación / Necessary materials for installation			Rendimiento Aprox. / Average Usage		Precio / Price	
	● MSA-30 Masilla Juntas Gris	1 Cartucho 2-3 Paneles	-			
	● PTX-03 Pintura Gris	1 Spray 8 Paneles	-			
	Comp-09 Esparto Rojo	1 Pliego 15 Paneles	-			
Complementos opcionales para la instalación / Optional materials for installation			Rendimiento Aprox. / Average Usage		Precio / Price	
	○ MSA-3 Masilla de Pegado	1 Cartucho 4-5 Paneles	-			
	● PTE-24 Pintura Envejecido Rojo	1 Spray 15 Paneles	-			
	● PTE-21 Pintura Envejecido Marrón	1 Spray 15 Paneles	-			

Las medidas pueden variar +/-1cm / Measurements may vary +/-1cm

Classic PIZARRA NEPAL

ACABADOS / FINISHES

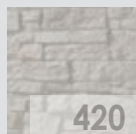

420
Blanco Arena /
Sandy White



421
Marrón /
Brown



422
Gris /
Grey

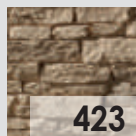

423
Marrón Arena /
Sandy Brown

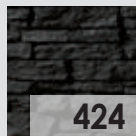

424
Antracita /
Anthracite

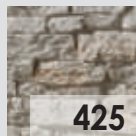

425
Blanco Italia /
Italia White

MEDIDAS / MEASUREMENTS

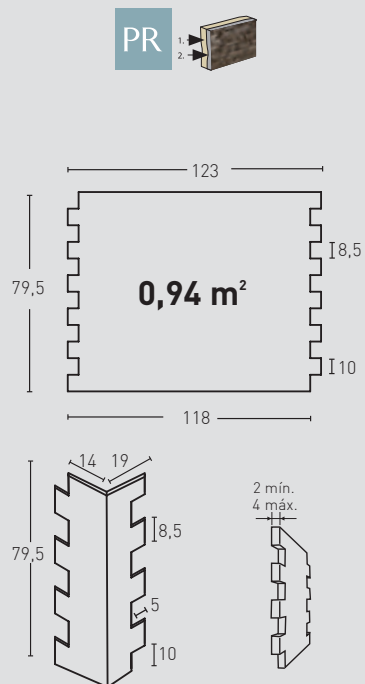

Las medidas pueden variar +/-1cm / Measurements may vary +/-1cm

PRODUCTO PRODUCT	COD.	DESCRIPCIÓN DESCRIPTION	KG			PR
PR	423 423-E	Panel Piz. Nepal Marrón Arena Ángulo Piz. Nepal Marrón Arena	PR: 7-8 kg PR: 2-3 kg	PR: 3 un PR: 2 un	PR: 36 un PR: 30 un	€/unidad - -

Complementos necesarios para la instalación / Necessary materials for installation

	Complementos necesarios para la instalación / Necessary materials for installation	Rendimiento Aprox. / Average Usage	Precio / Price
	● MSA-20 Masilla Juntas Beige	1 Cartucho 2-3 Paneles	-
	● PTX-02 Pintura Beige Juntas	1 Spray 8 Paneles	-
	○ PTE-33 Pintura Envejecido Caleado + Comp6 (Bote)	1 Spray 15 Paneles	-

Complementos opcionales para la instalación / Optional materials for installation

	Complementos opcionales para la instalación / Optional materials for installation	Rendimiento Aprox. / Average Usage	Precio / Price
	○ MSA-3 Masilla de Pegado	1 Cartucho 4-5 Paneles	-
	● PTE-31 Pintura Envejecido Piel	1 Spray 15 Paneles	-
	● PTE-36 Pintura Envejecido Rojizo	1 Spray 15 Paneles	-

PRODUCTO PRODUCT	COD.	DESCRIPCIÓN DESCRIPTION	KG			PR
PR	424 424-E	Panel Pizarra Nepal Antracita Ángulo Pizarra Nepal Antracita	PR: 7-8 kg PR: 2-3 kg	PR: 3 un PR: 2 un	PR: 36 un PR: 30 un	€/unidad - -

Complementos necesarios para la instalación / Necessary materials for installation

	Complementos necesarios para la instalación / Necessary materials for installation	Rendimiento Aprox. / Average Usage	Precio / Price
	● MSA-60 Masilla Juntas Antracita	1 Cartucho 2-3 Paneles	-
	● PTX-19 Pintura Antracita	1 Spray 6 Paneles	-

Complementos opcionales para la instalación / Optional materials for installation

	Complementos opcionales para la instalación / Optional materials for installation	Rendimiento Aprox. / Average Usage	Precio / Price
	○ MSA-3 Masilla de Pegado	1 Cartucho 4-5 Paneles	-

PRODUCTO PRODUCT	COD.	DESCRIPCIÓN DESCRIPTION	KG			PR
PR	425 425-E	Panel Piz. Nepal Blanco Italia Ángulo Piz. Nepal Blanco Italia	PR: 7-8 kg PR: 2-3 kg	PR: 3 un PR: 2 un	PR: 36 un PR: 30 un	€/unidad - -

Complementos necesarios para la instalación / Necessary materials for installation

	Complementos necesarios para la instalación / Necessary materials for installation	Rendimiento Aprox. / Average Usage	Precio / Price
	○ MSA-70 Masilla Juntas Blanco Italia	1 Cartucho 2-3 Paneles	-
	○ PTX-20 Pintura Blanco Italia	1 Spray 8 Paneles	-
	● PTE-22 Pintura Envejecido Gris	1 Spray 15 Paneles	-

Complementos opcionales para la instalación / Optional materials for installation

	Complementos opcionales para la instalación / Optional materials for installation	Rendimiento Aprox. / Average Usage	Precio / Price
	○ MSA-3 Masilla de Pegado	1 Cartucho 4-5 Paneles	-
	● PTE-24 Pintura Envejecido Rojo	1 Spray 15 Paneles	-
	● PTE-21 Pintura Envejecido Marrón	1 Spray 15 Paneles	-

Classic
PIZARRA
MONTBLANC

PANELPIEDRA®

PR



PR 431 Marrón



PR 435 Blanco Italia

Classic PIZARRA MONTBLANC

ACABADOS / FINISHES

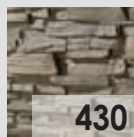

430
Blanco Arena /
Sandy White

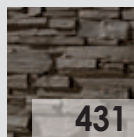

431
Marrón /
Brown

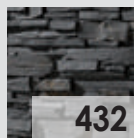

432
Gris /
Grey

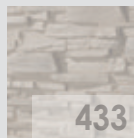

433
Marrón Arena /
Sandy Brown

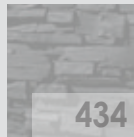

434
Antracita /
Anthracite

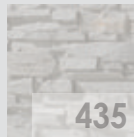

435
Blanco Italia /
Italia White

MEDIDAS / MEASUREMENTS

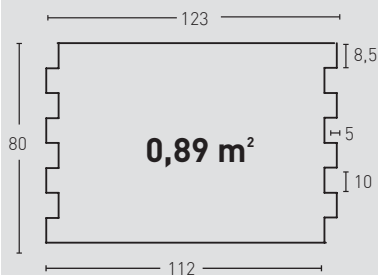

PRODUCTO PRODUCT	COD.	DESCRIPCIÓN DESCRIPTION	KG			PR
PR	430	Panel Pizarra Montblanc Blanco Arena	PR: 7-8 kg	PR: 3 un	PR: 36 un	€/unidad -
Complementos necesarios para la instalación / Necessary materials for installation			Rendimiento Aprox. / Average Usage		Precio / Price	
	<ul style="list-style-type: none"> ● MSA-10 Masilla Juntas Beige ● PTX-01 Pintura Beige Pizarra ● PTE-22 Pintura Envejecido Gris 		1 Cartucho 2-3 Paneles		-	
			1 Spray 8 Paneles		-	
			1 Spray 15 Paneles		-	
Complementos opcionales para la instalación / Optional materials for installation			Rendimiento Aprox. / Average Usage		Precio / Price	
	<ul style="list-style-type: none"> ○ MSA-3 Masilla de Pegado ● PTE-24 Pintura Envejecido Rojo ● PTE-21 Pintura Envejecido Marrón 		1 Cartucho 4-5 Paneles		-	
			1 Spray 15 Paneles		-	
			1 Spray 15 Paneles		-	
PRODUCTO PRODUCT	COD.	DESCRIPCIÓN DESCRIPTION	KG			PR
PR	431	Panel Pizarra Montblanc Marrón	PR: 7-8 kg	PR: 3 un	PR: 36 un	€/unidad -
Complementos necesarios para la instalación / Necessary materials for installation			Rendimiento Aprox. / Average Usage		Precio / Price	
	<ul style="list-style-type: none"> ○ MSA-70 Masilla Blanco Italia ● PTX-09 Pintura Marrón ● PTE-35 Pintura Envejecido Óxido 		1 Cartucho 2-3 Paneles		-	
			1 Spray 8 Paneles		-	
			1 Spray 15 Paneles		-	
Complementos opcionales para la instalación / Optional materials for installation			Rendimiento Aprox. / Average Usage		Precio / Price	
	<ul style="list-style-type: none"> ○ MSA-3 Masilla de Pegado ● PTE-37 Pintura Envejecido Marrón Oscuro 		1 Cartucho 4-5 Paneles		-	
			1 Spray 15 Paneles		-	
PRODUCTO PRODUCT	COD.	DESCRIPCIÓN DESCRIPTION	KG			PR
PR	432	Panel Pizarra Montblanc Gris	PR: 7-8 kg	PR: 3 un	PR: 36 un	€/unidad -
Complementos necesarios para la instalación / Necessary materials for installation			Rendimiento Aprox. / Average Usage		Precio / Price	
	<ul style="list-style-type: none"> ● MSA-30 Masilla Juntas Gris ● PTX-03 Pintura Gris Comp-09 Esparto Rojo 		1 Cartucho 2-3 Paneles		-	
			1 Spray 8 Paneles		-	
			1 Pliego 15 Paneles		-	
Complementos opcionales para la instalación / Optional materials for installation			Rendimiento Aprox. / Average Usage		Precio / Price	
	<ul style="list-style-type: none"> ○ MSA-3 Masilla de Pegado ● PTE-24 Pintura Envejecido Rojo ● PTE-21 Pintura Envejecido Marrón 		1 Cartucho 4-5 Paneles		-	
			1 Spray 15 Paneles		-	
			1 Spray 15 Paneles		-	

Las medidas pueden variar +/-1cm / Measurements may vary +/-1cm

Classic PIZARRA MONTBLANC

ACABADOS / FINISHES

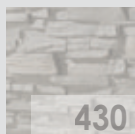

430
Blanco Arena /
Sandy White

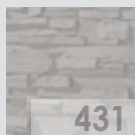

431
Marrón /
Brown

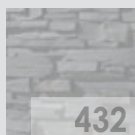

432
Gris /
Grey

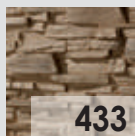

433
Marrón Arena /
Sandy Brown

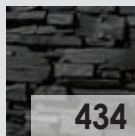

434
Antracita /
Anthracite

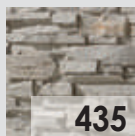

435
Blanco Italia /
Italia White

MEDIDAS / MEASUREMENTS

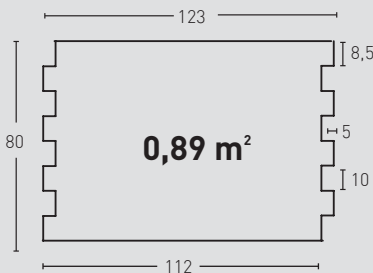

PRODUCTO PRODUCT	COD.	DESCRIPCIÓN DESCRIPTION	KG			PR
PR	433	Panel Pizarra Montblanc Marrón Arena	PR: 7-8 kg	PR: 3 un	PR: 36 un	-

Complementos necesarios para la instalación / Necessary materials for installation

Complementos necesarios para la instalación / Necessary materials for installation	Rendimiento Aprox. / Average Usage	Precio / Price
● MSA-20 Masilla Juntas Beige	1 Cartucho 2-3 Paneles	-
● PTX-02 Pintura Beige Juntas	1 Spray 8 Paneles	-
○ PTE-33 Pintura Envejecido Caleado + Compó (Bote)	1 Spray 15 Paneles	-

Complementos opcionales para la instalación / Optional materials for installation

Complementos opcionales para la instalación / Optional materials for installation	Rendimiento Aprox. / Average Usage	Precio / Price
○ MSA-3 Masilla de Pegado	1 Cartucho 4-5 Paneles	-
● PTE-31 Pintura Envejecido Piel	1 Spray 15 Paneles	-
● PTE-36 Pintura Envejecido Rojizo	1 Spray 15 Paneles	-

PRODUCTO PRODUCT	COD.	DESCRIPCIÓN DESCRIPTION	KG			PR
PR	434	Panel Pizarra Montblanc Antracita	PR: 7-8 kg	PR: 3 un	PR: 36 un	-

Complementos necesarios para la instalación / Necessary materials for installation

Complementos necesarios para la instalación / Necessary materials for installation	Rendimiento Aprox. / Average Usage	Precio / Price
● MSA-60 Masilla Juntas Antracita	1 Cartucho 2-3 Paneles	-
● PTX-19 Pintura Antracita	1 Spray 6 Paneles	-

Complementos opcionales para la instalación / Optional materials for installation

Complementos opcionales para la instalación / Optional materials for installation	Rendimiento Aprox. / Average Usage	Precio / Price
○ MSA-3 Masilla de Pegado	1 Cartucho 4-5 Paneles	-

PRODUCTO PRODUCT	COD.	DESCRIPCIÓN DESCRIPTION	KG			PR
PR	435	Panel Pizarra Montblanc Blanco Italia	PR: 7-8 kg	PR: 3 un	PR: 36 un	-

Complementos necesarios para la instalación / Necessary materials for installation

Complementos necesarios para la instalación / Necessary materials for installation	Rendimiento Aprox. / Average Usage	Precio / Price
○ MSA-70 Masilla Juntas Blanco Italia	1 Cartucho 2-3 Paneles	-
○ PTX-20 Pintura Blanco Italia	1 Spray 8 Paneles	-
● PTE-22 Pintura Envejecido Gris	1 Spray 15 Paneles	-

Complementos opcionales para la instalación / Optional materials for installation

Complementos opcionales para la instalación / Optional materials for installation	Rendimiento Aprox. / Average Usage	Precio / Price
○ MSA-3 Masilla de Pegado	1 Cartucho 4-5 Paneles	-
● PTE-24 Pintura Envejecido Rojo	1 Spray 15 Paneles	-
● PTE-21 Pintura Envejecido Marrón	1 Spray 15 Paneles	-

Classic PIZARRA ALPES

PANELPIEDRA®

PR

HD



PR 443 Marrón Arena



PR 440 Blanco Arena

Classic PIZARRA ALPES

ACABADOS / FINISHES

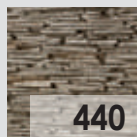

440
Blanco Arena /
Sandy White

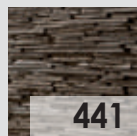

441
Marrón /
Brown

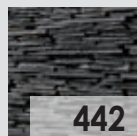

442
Gris /
Grey

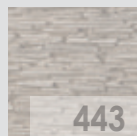

443
Marrón Arena /
Sandy Brown

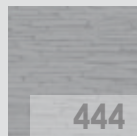

444
Antracita /
Anthracite

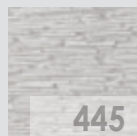

445
Blanco Italia /
Italia White

MEDIDAS / MEASUREMENTS

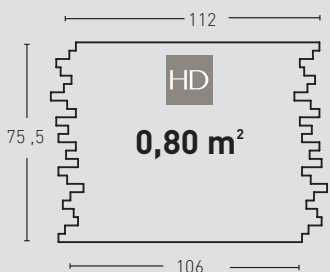
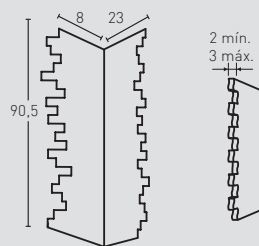
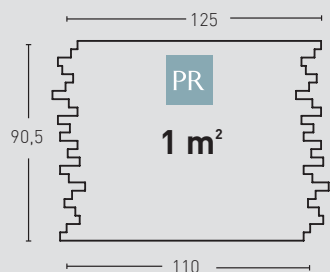

PRODUCTO PRODUCT	COD.	DESCRIPCIÓN DESCRIPTION	KG			PR	HD
PR HD	440 440-E	Panel Pizarra Alpes Blanco Arena Áng. Pizarra Alpes Blanco Arena	PR:8-9kg / HD:15-20kg PR: 3-4 kg / HD: --	PR:3un / HD:25un PR:3un / HD: --	PR:36un / HD:25un PR:45un / HD: --	-	-
			€/unidad		-	-	-
					-	-	*consultar

Complementos necesarios para la instalación / Necessary materials for installation



- MSA-10 Masilla Juntas Beige
- PTX-01 Pintura Beige Pizarra
- PTE-22 Pintura Envejecido Gris

- 1 Cartucho 2-3 Paneles
- 1 Spray 8 Paneles
- 1 Spray 15 Paneles

Rendimiento Aprox. / Average Usage

-
-
-

Complementos opcionales para la instalación / Optional materials for installation



- MSA-3 Masilla de Pegado
- PTE-24 Pintura Envejecido Rojo
- PTE-21 Pintura Envejecido Marrón

- 1 Cartucho 4-5 Paneles
- 1 Spray 15 Paneles
- 1 Spray 15 Paneles

Rendimiento Aprox. / Average Usage

-
-
-

PRODUCTO PRODUCT	COD.	DESCRIPCIÓN DESCRIPTION	KG			PR	HD
PR HD	441 441-E	Panel Pizarra Alpes Marrón Ángulo Pizarra Alpes Marrón	PR:8-9kg / HD:15-20kg PR: 3-4 kg / HD: --	PR:3un / HD:25un PR:3un / HD: --	PR:36un / HD:25un PR:45un / HD: --	-	-
			€/unidad		-	-	-
					-	-	*consultar

Complementos necesarios para la instalación / Necessary materials for installation



- MSA-70 Masilla Juntas Blanco Italia
- PTX-09 Pintura Marrón
- PTE-35 Pintura Envejecido Óxido

- 1 Cartucho 2-3 Paneles
- 1 Spray 8 Paneles
- 1 Spray 15 Paneles

Rendimiento Aprox. / Average Usage

-
-
-

Complementos opcionales para la instalación / Optional materials for installation



- MSA-3 Masilla de Pegado
- PTE-37 Pintura Envejecido Marrón Oscuro

- 1 Cartucho 4-5 Paneles
- 1 Spray 15 Paneles

Rendimiento Aprox. / Average Usage

-
-

PRODUCTO PRODUCT	COD.	DESCRIPCIÓN DESCRIPTION	KG			PR	HD
PR HD	442 442-E	Panel Pizarra Alpes Gris Ángulo Pizarra Alpes Gris	PR:8-9kg / HD:15-20kg PR: 3-4 kg / HD: --	PR:3un / HD:25un PR:3un / HD: --	PR:36un / HD:25un PR:45un / HD: --	-	-
			€/unidad		-	-	-
					-	-	*consultar

Complementos necesarios para la instalación / Necessary materials for installation



- MSA-30 Masilla Juntas Gris
- PTX-03 Pintura Gris
- Comp-09 Esparto Rojo

- 1 Cartucho 2-3 Paneles
- 1 Spray 8 Paneles
- 1 Pliego 15 Paneles

Rendimiento Aprox. / Average Usage

-
-
-

Complementos opcionales para la instalación / Optional materials for installation



- MSA-3 Masilla de Pegado
- PTE-24 Pintura Envejecido Rojo
- PTE-21 Pintura Envejecido Marrón

- 1 Cartucho 4-5 Paneles
- 1 Spray 15 Paneles
- 1 Spray 15 Paneles

Rendimiento Aprox. / Average Usage

-
-
-

Las medidas pueden variar +/-1cm / Measurements may vary +/-1cm

Classic PIZARRA ALPES

ACABADOS / FINISHES

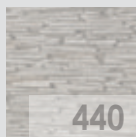

440
Blanco Arena /
Sandy White

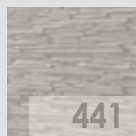

441
Marrón /
Brown



442
Gris /
Grey

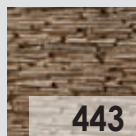

443
Marrón Arena /
Sandy Brown

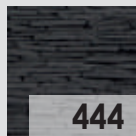

444
Antracita /
Anthracite

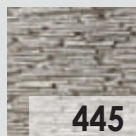

445
Blanco Italia /
Italia White

MEDIDAS / MEASUREMENTS

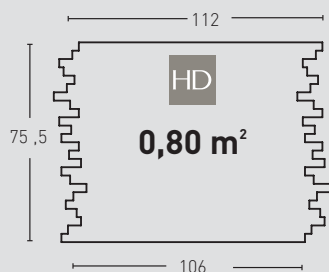
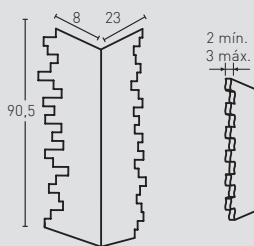
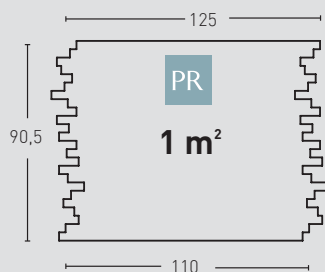

PRODUCTO PRODUCT	COD.	DESCRIPCIÓN DESCRIPTION				PR	HD
PR HD	443 443-E	Panel Piz. Alpes Marrón Arena Ángulo Piz. Alpes Marrón Arena	PR:8-9kg / HD:15-20kg PR: 3-4 kg	PR:3un / HD:25un PR: 3 un	PR:36un / HD:25un PR: 45 un	-	-
						€/unidad - *	
						- consultar	

Complementos necesarios para la instalación / Necessary materials for installation



- MSA-20 Masilla Juntas Beige
- PTX-02 Pintura Beige Juntas
- PTE-33 Pintura Envejecido Caleado + Comp6 (Bote)

Rendimiento Aprox. / Average Usage

- 1 Cartucho 2-3 Paneles
- 1 Spray 8 Paneles
- 1 Spray 15 Paneles

Precio / Price

-
-
-

Complementos opcionales para la instalación / Optional materials for installation



- MSA-3 Masilla de Pegado
- PTE-31 Pintura Envejecido Piel
- PTE-36 Pintura Envejecido Rojizo

Rendimiento Aprox. / Average Usage

- 1 Cartucho 4-5 Paneles
- 1 Spray 15 Paneles
- 1 Spray 15 Paneles

Precio / Price

-
-
-

PRODUCTO PRODUCT	COD.	DESCRIPCIÓN DESCRIPTION				PR	HD
PR HD	444 444-E	Panel Pizarra Alpes Antracita Ángulo Pizarra Alpes Antracita	PR:8-9kg / HD:15-20kg PR: 3-4 kg	PR:3un / HD:25un PR: 3 un	PR:36un / HD:25un PR: 45 un	-	-
						€/unidad - *	
						- consultar	

Complementos necesarios para la instalación / Necessary materials for installation



- MSA-60 Masilla Juntas Antracita
- PTX-19 Pintura Antracita

Rendimiento Aprox. / Average Usage

- 1 Cartucho 2-3 Paneles
- 1 Spray 6 Paneles

Precio / Price

-
-

Complementos opcionales para la instalación / Optional materials for installation



- MSA-3 Masilla de Pegado

Rendimiento Aprox. / Average Usage

- 1 Cartucho 4-5 Paneles

Precio / Price

-

PRODUCTO PRODUCT	COD.	DESCRIPCIÓN DESCRIPTION				PR	HD
PR HD	445 445-E	Panel Piz. Alpes Blanco Italia Ángulo Piz. Alpes Blanco Italia	PR:8-9kg / HD:15-20kg PR: 3-4 kg	PR:3un / HD:25un PR: 3 un	PR:36un / HD:25un PR: 45 un	-	-
						€/unidad - *	
						- consultar	

Complementos necesarios para la instalación / Necessary materials for installation



- MSA-70 Masilla Juntas Blanco Italia
- PTX-20 Pintura Blanco Italia
- PTE-22 Pintura Envejecido Gris

Rendimiento Aprox. / Average Usage

- 1 Cartucho 2-3 Paneles
- 1 Spray 8 Paneles
- 1 Spray 15 Paneles

Precio / Price

-
-
-

Complementos opcionales para la instalación / Optional materials for installation



- MSA-3 Masilla de Pegado
- PTE-24 Pintura Envejecido Rojo
- PTE-21 Pintura Envejecido Marrón

Rendimiento Aprox. / Average Usage

- 1 Cartucho 4-5 Paneles
- 1 Spray 15 Paneles
- 1 Spray 15 Paneles

Precio / Price

-
-
-

Classic BAZTÁN

PANELPIEDRA®

PR



PR 37 Marrón Arena



PR 35 Blanco Arena

Classic BAZTÁN

ACABADOS / FINISHES

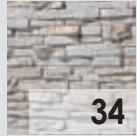

34

Blanco Italia / Italian White

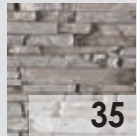

35

Blanco Arena / Sandy White

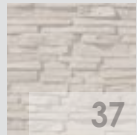

37

Marrón Arena / Sandy Brown

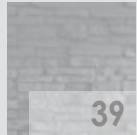

39

Gris / Grey

MEDIDAS / MEASUREMENTS

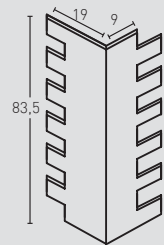
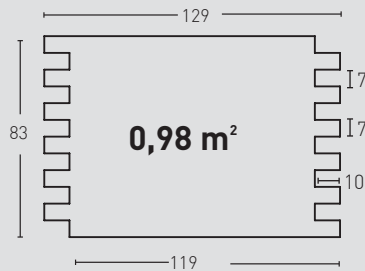
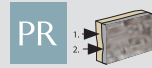

3 min.
6 máx.

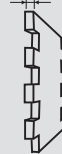

PRODUCTO PRODUCT	COD.	DESCRIPCIÓN DESCRIPTION	KG			PR
PR	34 34-E	Panel Baztán Blanco Italia Ángulo Baztán Blanco Italia	PR: 8-9 kg PR: 3-4 kg	PR: 2 un PR: 2 un	PR: 24 un PR: 30 un	€/unidad - -

Complementos necesarios para la instalación / Necessary materials for installation

Complementos necesarios para la instalación / Necessary materials for installation	Rendimiento Aprox. / Average Usage	Precio / Price
MSA-70 Masilla Juntas Blanco Italia PTX-20 Pintura Blanco Italia PTE-22 Pintura Envejecido Gris	1 Cartucho 2-3 Paneles 1 Bote 8 Paneles 1 Spray 15 Paneles	- - -

Complementos opcionales para la instalación / Optional materials for installation

Complementos opcionales para la instalación / Optional materials for installation	Rendimiento Aprox. / Average Usage	Precio / Price
MSA-3 Masilla de Pegado PTE-24 Pintura Envejecido Rojo PTE-21 Pintura Envejecido Marrón	1 Cartucho 4-5 Paneles 1 Spray 15 Paneles 1 Spray 15 Paneles	- - -

PRODUCTO PRODUCT	COD.	DESCRIPCIÓN DESCRIPTION	KG			PR
PR	35 35-E	Panel Baztán Blanco Arena Ángulo Baztán Blanco Arena	PR: 8-9 kg PR: 3-4 kg	PR: 2 un PR: 2 un	PR: 24 un PR: 30 un	€/unidad - -

Complementos necesarios para la instalación / Necessary materials for installation

Complementos necesarios para la instalación / Necessary materials for installation	Rendimiento Aprox. / Average Usage	Precio / Price
MSA-10 Masilla Juntas Beige PTX-01 Pintura Beige Pizarra PTE-22 Pintura Envejecido Gris	1 Cartucho 3 Paneles 1 Spray 8 Paneles 1 Spray 15 Paneles	- - -

Complementos opcionales para la instalación / Optional materials for installation

Complementos opcionales para la instalación / Optional materials for installation	Rendimiento Aprox. / Average Usage	Precio / Price
MSA-3 Masilla de Pegado PTE-24 Pintura Envejecido Rojo PTE-21 Pintura Envejecido Marrón	1 Cartucho 4-5 Paneles 1 Spray 15 Paneles 1 Spray 15 Paneles	- - -

Las medidas pueden variar +/-1cm / Measurements may vary +/-1cm

Classic BAZTÁN

ACABADOS / FINISHES

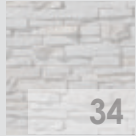

34
Blanco Arena /
Sandy White

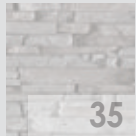

35
Gris /
Grey

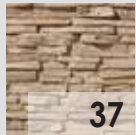

37
Marrón Arena /
Sandy Brown

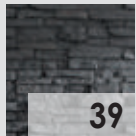

39
Antracita /
Anthracite

MEDIDAS / MEASUREMENTS

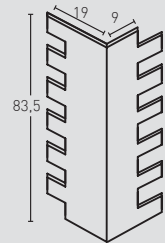
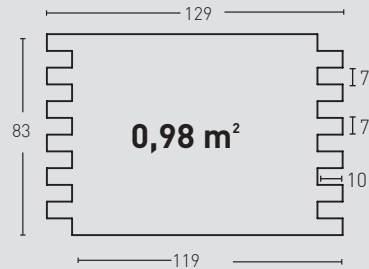

PRODUCTO PRODUCT	COD.	DESCRIPCIÓN DESCRIPTION	KG			PR	€/unidad
PR	37 37-E	Panel Baztán Marrón Arena	PR: 8-9 kg	PR: 2 un	PR: 24 un	-	-
		Ángulo Baztán Marrón Arena	PR: 3-4 kg	PR: 2 un	PR: 30 un	-	-

Complementos necesarios para la instalación / Necessary materials for installation



- MSA-20 Masilla Juntas Beige
- PTX-02 Pintura Beige Juntas
- PTE-33 Pintura Envejecido Caleado + Comp6 (Bote)

Rendimiento Aprox. / Average Usage

- 1 Cartucho 2-3 Paneles
- 1 Spray 8 Paneles
- 1 Spray 15 Paneles

Precio / Price

-
-
-

Complementos opcionales para la instalación / Optional materials for installation



- MSA-3 Masilla de Pegado
- PTE-31 Pintura Envejecido Piel
- PTE-36 Pintura Envejecido Rojizo

Rendimiento Aprox. / Average Usage

- 1 Cartucho 4-5 Paneles
- 1 Spray 15 Paneles
- 1 Spray 15 Paneles

Precio / Price

-
-
-

PRODUCTO PRODUCT	COD.	DESCRIPCIÓN DESCRIPTION	KG			PR	€/unidad
PR	39 39-E	Panel Baztán Gris	PR: 8-9 kg	PR: 2 un	PR: 24 un	-	-
		Ángulo Baztán Gris	PR: 3-4 kg	PR: 2 un	PR: 30 un	-	-

Complementos necesarios para la instalación / Necessary materials for installation



- MSA-30 Masilla Juntas Gris
- PTX-03 Pintura Gris
- Comp-09 Esparto Rojo

Rendimiento Aprox. / Average Usage

- 1 Cartucho 2-3 Paneles
- 1 Spray 8 Paneles
- 1 Pliego 15 Paneles

Precio / Price

-
-
-

Complementos opcionales para la instalación / Optional materials for installation



- MSA-3 Masilla de Pegado
- PTE-24 Pintura Envejecido Rojo
- PTE-21 Pintura Envejecido Marrón

Rendimiento Aprox. / Average Usage

- 1 Cartucho 4-5 Paneles
- 1 Spray 15 Paneles
- 1 Spray 15 Paneles

Precio / Price

-
-
-

Classic LIÉBANA

PANELPIEDRA®

PR

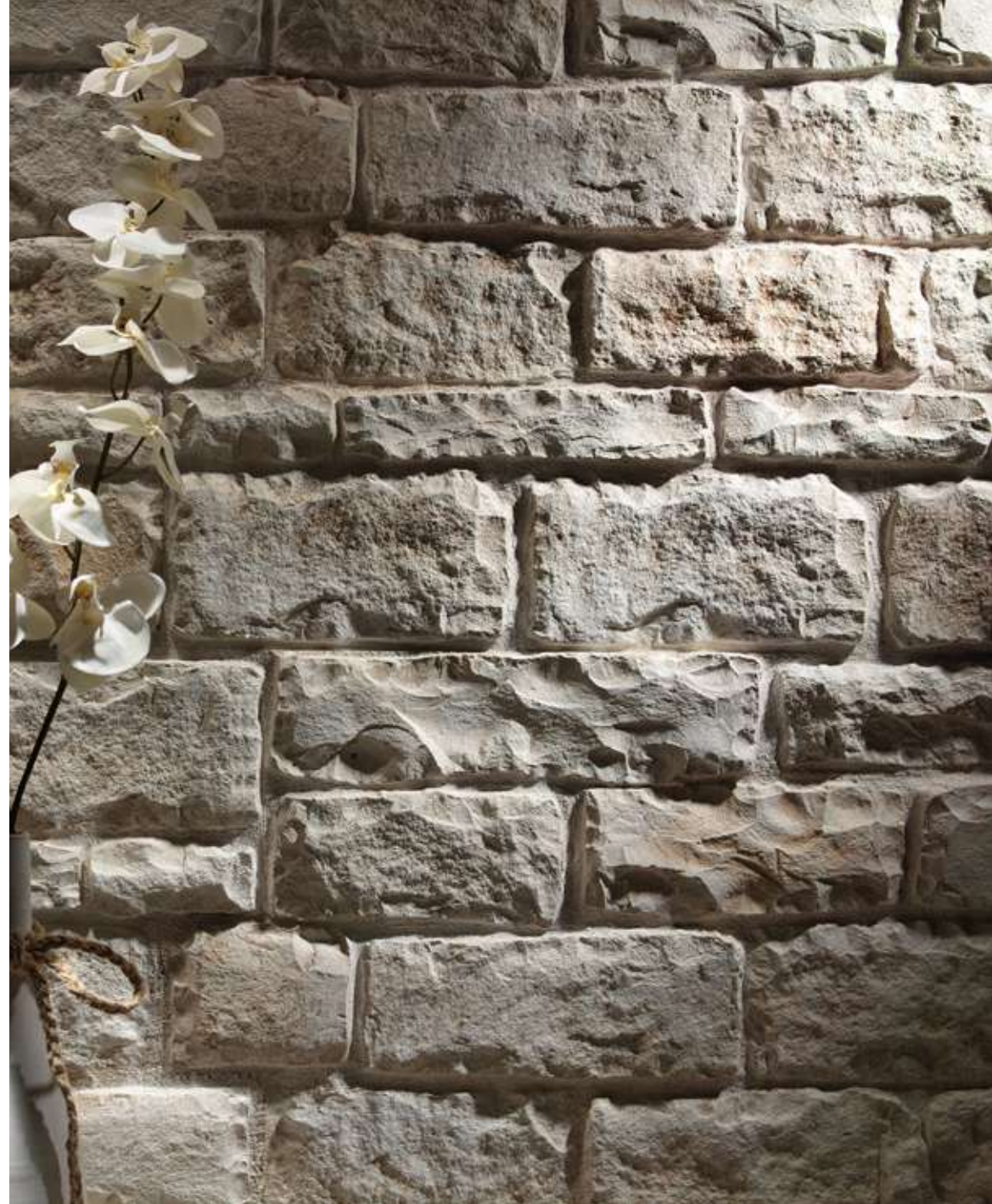

PR 52 Blanco Arena



PR 52 Blanco Arena



PR 52 Blanco Arena



Classic LIÉBANA

ACABADOS / FINISHES



52

Blanco Arena /
Sandy White

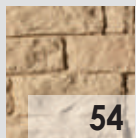

54

Marrón Tierra /
Sandy Brown



55

Blanco Italia /
Italia White

MEDIDAS / MEASUREMENTS

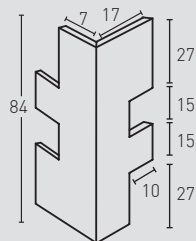
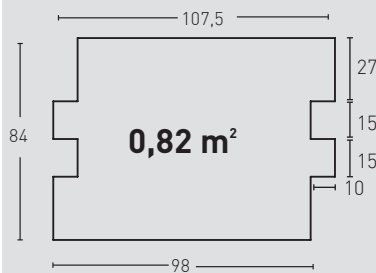

1 mín.
4 máx.



PRODUCTO PRODUCT	COD.	DESCRIPCIÓN DESCRIPTION				PR
PR	52 52-E	Panel Liébana Blanco Arena	PR: 6-7 kg	PR: 3 un	PR: 36 un	€/unidad -
		Ángulo Liébana Blanco Arena	PR: 2-3 kg	PR: 3 un	PR: 45 un	-

Complementos necesarios para la instalación / Necessary materials for installation

Rendimiento Aprox. / Average Usage

Precio / Price



- MSA-10 Masilla Juntas Beige
- PTX-01 Pintura Beige Pizarra
- PTE-21 Pintura Envejecido Marrón

- 1 Cartucho 3 Paneles
- 1 Spray 8 Paneles
- 1 Spray 15 Paneles

-
-
-

Complementos opcionales para la instalación / Optional materials for installation

Rendimiento Aprox. / Average Usage

Precio / Price



- MSA-3 Masilla de Pegado
- PTE-24 Pintura Envejecido Rojo

- 1 Cartucho 4-5 Paneles
- 1 Spray 15 Paneles

-
-

PRODUCTO PRODUCT	COD.	DESCRIPCIÓN DESCRIPTION				PR
PR	54 54-E	Panel Liébana Marrón Tierra	PR: 6-7 kg	PR: 3 un	PR: 36 un	€/unidad -
		Ángulo Liébana Marrón Tierra	PR: 2-3 kg	PR: 3 un	PR: 45 un	-

Complementos necesarios para la instalación / Necessary materials for installation

Rendimiento Aprox. / Average Usage

Precio / Price



- MSA-20 Masilla Juntas Beige
- PTX-02 Pintura Beige Juntas
- PTE-33 Pintura Envejecido Caleado + Compó (Bote)

- 1 Cartucho 2-3 Paneles
- 1 Spray 8 Paneles
- 1 Spray 15 Paneles

-
-
-

Complementos opcionales para la instalación / Optional materials for installation

Rendimiento Aprox. / Average Usage

Precio / Price



- MSA-3 Masilla de Pegado
- PTE-31 Pintura Envejecido Piel
- PTE-36 Pintura Envejecido Rojizo

- 1 Cartucho 4-5 Paneles
- 1 Spray 15 Paneles
- 1 Spray 15 Paneles

-
-
-

PRODUCTO PRODUCT	COD.	DESCRIPCIÓN DESCRIPTION				PR
PR	55 55-E	Panel Liébana Blanco Italia	PR: 6-7 kg	PR: 3 un	PR: 36 un	€/unidad -
		Ángulo Liébana Blanco Italia	PR: 2-3 kg	PR: 3 un	PR: 45 un	-

Complementos necesarios para la instalación / Necessary materials for installation

Rendimiento Aprox. / Average Usage

Precio / Price



- MSA-70 Masilla Juntas Blanco Italia
- PTX-20 Pintura Blanco Italia
- PTE-21 Pintura Envejecido Marrón

- 1 Cartucho 3 Paneles
- 1 Bote 8 Paneles
- 1 Spray 15 Paneles

-
-
-

Complementos opcionales para la instalación / Optional materials for installation

Rendimiento Aprox. / Average Usage

Precio / Price



- MSA-3 Masilla de Pegado
- PTE-24 Pintura Envejecido Rojo

- 1 Cartucho 4-5 Paneles
- 1 Spray 15 Paneles

-
-

Classic TÍBET

PANELPIEDRA®

PR



PR 332 Rojo Teja



PR 330 Blanco Arena

PR 332 Rojo Teja



Classic TÍBET

ACABADOS / FINISHES



330

Blanco Arena /
Sandy White

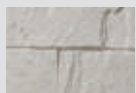

331

Blanco Italia /
Italian White

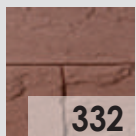

332

Rojo Teja /
Brick Red

MEDIDAS / MEASUREMENTS

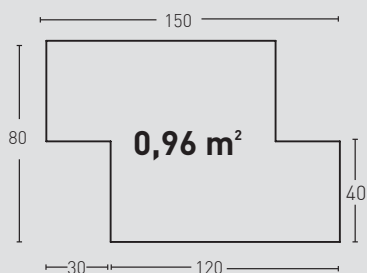

1 mín.
3 máx.



PRODUCTO PRODUCT	COD.	DESCRIPCIÓN DESCRIPTION	KG			PR	€/unidad
PR	330	Panel Tíbet Blanco Arena	PR: 6-7 kg	PR: 4 un	PR: 48 un	-	-

Complementos necesarios para la instalación / Necessary materials for installation



- MSA-10 Masilla Juntas Beige
- PTX-01 Pintura Beige Pizarra
- PTE-21 Pintura Envejecido Marrón

Rendimiento Aprox. / Average Usage

- 1 Cartucho 3 Paneles
- 1 Spray 8 Paneles
- 1 Spray 15 Paneles

Precio / Price

-
-
-

Complementos opcionales para la instalación / Optional materials for installation



- MSA-3 Masilla de Pegado
- PTE-35 Pintura Envejecido Óxido

Rendimiento Aprox. / Average Usage

- 1 Cartucho 4-5 Paneles
- 1 Spray 15 Paneles

Precio / Price

-
-

PRODUCTO PRODUCT	COD.	DESCRIPCIÓN DESCRIPTION	KG			PR	€/unidad
PR	331	Panel Tíbet Blanco Italia	PR: 6-7 kg	PR: 4 un	PR: 48 un	-	-

Complementos necesarios para la instalación / Necessary materials for installation



- MSA-70 Masilla Juntas Blanco Italia
- PTX-20 Pintura Blanco Italia

Rendimiento Aprox. / Average Usage

- 1 Cartucho 3 Paneles
- 1 Spray 8 Paneles

Precio / Price

-
-

Complementos opcionales para la instalación / Optional materials for installation



- MSA-3 Masilla de Pegado

Rendimiento Aprox. / Average Usage

- 1 Cartucho 4-5 Paneles

Precio / Price

-

PRODUCTO PRODUCT	COD.	DESCRIPCIÓN DESCRIPTION	KG			PR	€/unidad
PR	332	Panel Tíbet Rojo Teja	PR: 6-7 kg	PR: 4 un	PR: 48 un	-	-

Complementos necesarios para la instalación / Necessary materials for installation



- MSA-70 Masilla Juntas Blanco Italia
- PTX-11 Pintura Rojo Viejo
- PTE-23 Pintura Envejecido Blanco

Rendimiento Aprox. / Average Usage

- 1 Cartucho 3 Paneles
- 1 Bote 8 Paneles
- 1 Spray 15 Paneles

Precio / Price

-
-
-

Complementos opcionales para la instalación / Optional materials for installation



- MSA-3 Masilla de Pegado

Rendimiento Aprox. / Average Usage

- 1 Cartucho 4-5 Paneles

Precio / Price

-

Classic LASTRA

PANELPIEDRA®

PR



PR 75 Ibérico



PR 75 Ibérico

PR 75 Ibérico



Classic LASTRA

ACABADOS / FINISHES



75

Ibérico / Iberian



IMPR07

Ibérico / Iberian



IMPR09

Ibérico / Iberian

MEDIDAS / MEASUREMENTS

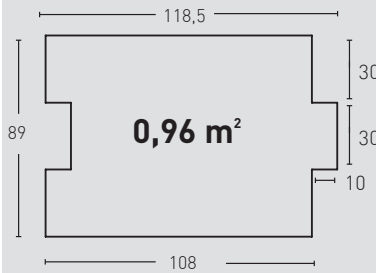

1 mín.
3 máx.

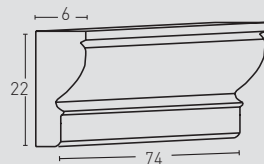
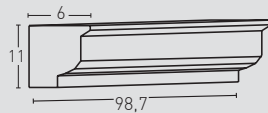

PRODUCTO PRODUCT	COD.	DESCRIPCIÓN DESCRIPTION	KG			PR
PR	75	Panel Lastra Ibérico	PR: 6-7 kg	PR: 4 un	PR: 48 un	€/unidad -
	IMPR-07	Moldura Lastra Ibérico	PR: 1-2 kg	PR: 1 un	PR: 100 un	-
	IMPR-09	Moldura Lastra Ibérico	PR: 2-3 kg	PR: 1 un	PR: 100 un	-

Complementos necesarios para la instalación / Necessary materials for installation



- MSA-70 Masilla Juntas Blanco Italia
- PTX-05 Pintura Beige Piedra
- PTE-27 Pintura Envejecido

Rendimiento Aprox. / Average Usage

- 1 Cartucho 3 Paneles
- 1 Bote 8 Paneles
- 1 Spray 15 Paneles

Precio / Price

-
-
-

Complementos opcionales para la instalación / Optional materials for installation



- MSA-3 Masilla de Pegado

Rendimiento Aprox. / Average Usage

- 1 Cartucho 4-5 Paneles

Precio / Price

-



Classic SILLARES

PANELPIEDRA®

PR



PR 32 Ibérico



PR 32 Ibérico

PR 32 Ibérico



Classic SILLARES

ACABADOS / FINISHES



Ibérico / Iberian



Ibérico / Iberian



Ibérico / Iberian



Ibérico / Iberian

MEDIDAS / MEASUREMENTS

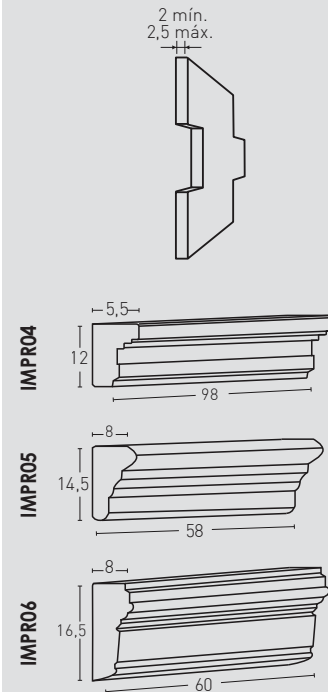
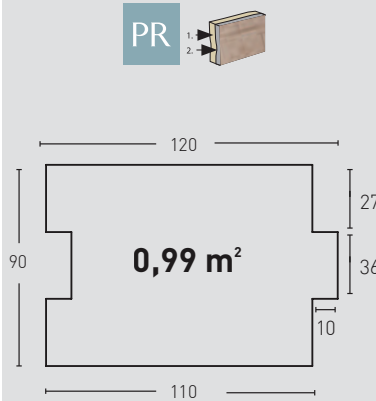

PRODUCTO PRODUCT	COD.	DESCRIPCIÓN DESCRIPTION	KG			PR	€/unidad
PR	32	Panel Sillares Ibérico	PR: 6-7 kg	PR: 4un	PR: 48 un	-	-
	IMPR-04	Moldura Sillares Ibérico	PR: 1-2 kg	PR: 1un	PR: 100 un	-	-
	IMPR-05	Moldura Sillares Ibérico	PR: 2-3 kg	PR: 1un	PR: 100 un	-	-
	IMPR-06	Moldura Sillares Ibérico	PR: 2-3 kg-	PR: 1un	PR: 100 un	-	-
Complementos necesarios para la instalación / Necessary materials for installation				Rendimiento Aprox. / Average Usage		Precio / Price	
		<input type="checkbox"/> MSA-70 Masilla Juntas Blanco Italia	1 Cartucho 3 Paneles		-		
		<input type="checkbox"/> PTX-05 Pintura Beige Piedra	1 Bote 8 Paneles		-		
		<input type="checkbox"/> PTE-27 Pintura Envejecido	1 Spray 15 Paneles		-		
Complementos opcionales para la instalación / Optional materials for installation				Rendimiento Aprox. / Average Usage		Precio / Price	
		<input type="checkbox"/> MSA-3 Masilla de Pegado	1 Cartucho 4-5 Paneles		-		

Classic SILLAREJOS

PANELPIEDRA®

PR



PR 30 Marrón Arena



PR 28 Blanco Italia

PR 30 Marrón Arena



Classic SILLAREJOS

ACABADOS / FINISHES

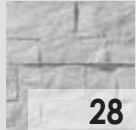

28

Blanco Arena / Sandy White

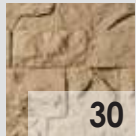

30

Marrón Arena / Sandy Brown

MEDIDAS / MEASUREMENTS

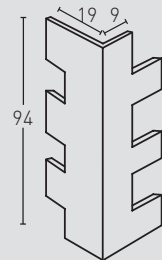
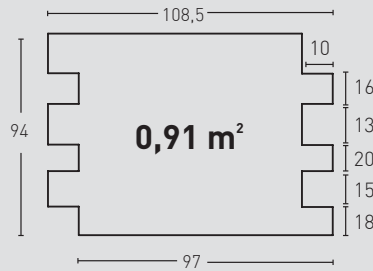

1,5 mín.
3 máx.

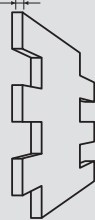

Las medidas pueden variar +/- 1cm / Measurements may vary +/- 1cm

PRODUCTO PRODUCT	COD.	DESCRIPCIÓN DESCRIPTION				PR
PR	28	Panel Sillarejos Blanco Italia	PR: 6-7 kg	PR: 4 un	PR: 48 un	€/unidad
	28-E	Ángulo Sillarejos Blanco Italia	PR: 2 kg	PR: 4 un	PR: 60 un	-

Complementos necesarios para la instalación / Necessary materials for installation

Complementos necesarios para la instalación / Necessary materials for installation	Rendimiento Aprox. / Average Usage	Precio / Price
MSA-70 Masilla Juntas Blanco Italia	1 Cartucho 2-3 Paneles	-
PTX-20 Pintura Blanco Italia	1 Spray 8 Paneles	-

Complementos opcionales para la instalación / Optional materials for installation

Complementos opcionales para la instalación / Optional materials for installation	Rendimiento Aprox. / Average Usage	Precio / Price
MSA-3 Masilla de Pegado	1 Cartucho 4-5 Paneles	-

PRODUCTO PRODUCT	COD.	DESCRIPCIÓN DESCRIPTION				PR
PR	30	Panel Sillarejos Marrón Arena	PR: 6-7 kg	PR: 4 un	PR: 48 un	€/unidad
	30-E	Ángulo Sillarejos Marrón Arena	PR: 2 kg	PR: 4 un	PR: 60 un	-

Complementos necesarios para la instalación / Necessary materials for installation

Complementos necesarios para la instalación / Necessary materials for installation	Rendimiento Aprox. / Average Usage	Precio / Price
MSA-70 Masilla Juntas Blanco Italia	1 Cartucho 2-3 Paneles	-
PTX-05 Pintura Beige Piedra	1 Spray 8 Paneles	-
PTE-21 Pintura Envejecido Marrón	1 Spray 15 Paneles	-

Complementos opcionales para la instalación / Optional materials for installation

Complementos opcionales para la instalación / Optional materials for installation	Rendimiento Aprox. / Average Usage	Precio / Price
MSA-3 Masilla de Pegado	1 Cartucho 4-5 Paneles	-

Classic
SILLAR
PICADO

PANELPIEDRA®

PR

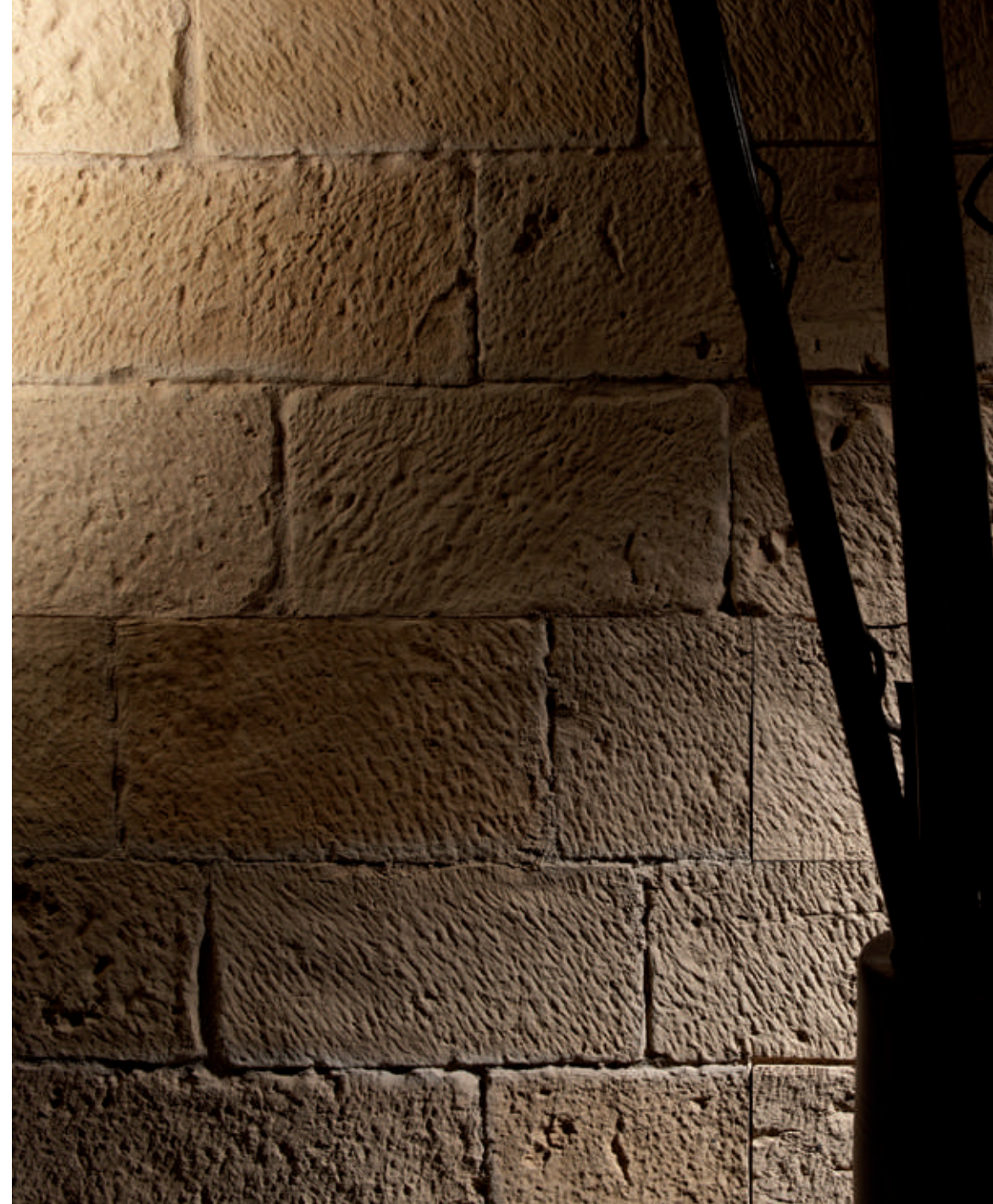

PR 100 Ocre

Classic SILLAR PICADO

ACABADOS / FINISHES



100

Ocre / Ochre

MEDIDAS / MEASUREMENTS

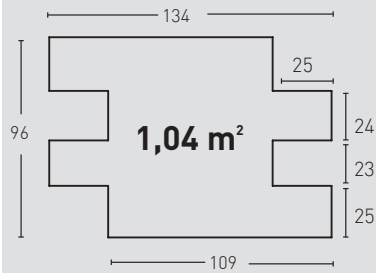

1,5 mín.
3 máx.

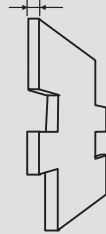

PRODUCTO PRODUCT	COD.	DESCRIPCIÓN DESCRIPTION	KG			PR	€/unidad
PR	100	Panel Sillar Picado Ocre	PR: 7-8 kg	PR: 4 un	PR: 48 un	-	-
Complementos necesarios para la instalación / Necessary materials for installation				Rendimiento Aprox. / Average Usage		Precio / Price	
		○ MSA-70 Masilla Juntas Blanco Italia			1 Cartucho 2-3 Paneles		-
		● PTX-05 Pintura Beige Piedra			1 Spray 8 Paneles		-
		● PTE-21 Pintura Envejecido Marrón			1 Spray 15 Paneles		-
Complementos opcionales para la instalación / Optional materials for installation				Rendimiento Aprox. / Average Usage		Precio / Price	
		○ MSA-3 Masilla de Pegado			1 Cartucho 4-5 Paneles		-
		● PTX-01 Pintura Beige Pizarra			1 Spray 15 Paneles		-
		● PTE-36 Pintura Envejecido Rojizo			1 Spray 15 Paneles		-
		● PTE-26 Pintura Envejecido Ocre			1 Spray 15 Paneles		-

Classic SILLAR VIEJO

PANELPIEDRA®

PR



PR 170 Ocre

Classic SILLAR VIEJO

ACABADOS / FINISHES

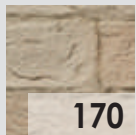

Ocre / Ochre

MEDIDAS / MEASUREMENTS

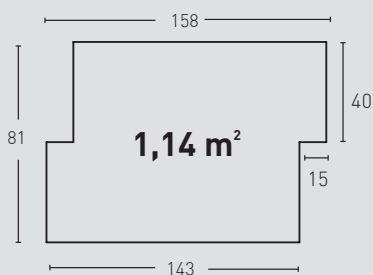

1 mín.
3 máx.



PRODUCTO PRODUCT	COD.	DESCRIPCIÓN DESCRIPTION	KG			PR	€/unidad
PR	170	Panel Sillar Viejo Ocre	PR: 7-8 kg	PR: 4 un	PR: 48 un	-	-
Complementos necesarios para la instalación / Necessary materials for installation				Rendimiento Aprox. / Average Usage		Precio / Price	
		○ MSA-70 Masilla Juntas Blanco Italia			1 Cartucho 2-3 Paneles		-
		● PTX-05 Pintura Beige Piedra			1 Spray 8 Paneles		-
		● PTE-21 Pintura Envejecido Marrón			1 Spray 15 Paneles		-
		● PTX-17 Pintura Juntas Verdoso			1 Spray 15 Paneles		-
Complementos opcionales para la instalación / Optional materials for installation				Rendimiento Aprox. / Average Usage		Precio / Price	
		○ MSA-3 Masilla de Pegado			1 Cartucho 4-5 Paneles		-
		● PTE-36 Pintura Envejecido Rojizo			1 Spray 15 Paneles		-
		● PTE-26 Pintura Envejecido Ocre			1 Spray 15 Paneles		-

Los medidos pueden variar +/-1cm / Measurements may vary +/-1cm

CLASSIC

Classic MAMPOSTERÍA REGULAR

PANELPIEDRA®

PR



PR 12 Blanco Arena



PR 11 Marrón Arena



PR 13 Blanco Italia

Classic MAMPOSTERÍA REGULAR

ACABADOS / FINISHES



11
Marrón Arena /
Sandy Brown



12
Blanco Arena /
Sandy White

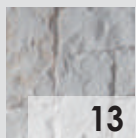

13
Blanco Italia /
Italia White

MEDIDAS / MEASUREMENTS

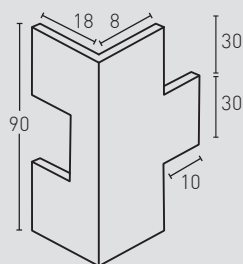
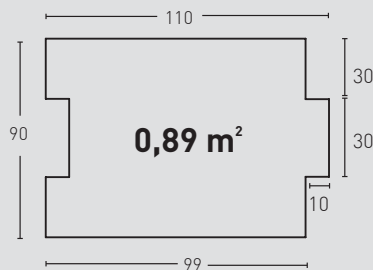

1 mín.
3 máx.



PRODUCTO PRODUCT	COD.	DESCRIPCIÓN DESCRIPTION	KG			PR	€/unidad
PR	11	Panel M. Regular Marrón Arena	PR: 6-7 kg	PR: 4 un	PR: 48 un	-	-
	11-E	Ángulo M. Regular Marrón Arena	PR: 2-3 kg	PR: 4 un	PR: 60 un	-	-

Complementos necesarios para la instalación / Necessary materials for installation

Complementos necesarios para la instalación / Necessary materials for installation	Rendimiento Aprox. / Average Usage	Precio / Price
● MSA-20 Masilla Juntas Beige	1 Cartucho 2-3 Paneles	-
● PTX-02 Pintura Beige Juntas	1 Spray 8 Paneles	-
○ PTE-33 Pintura Envejecido Caleado + Comp6 (Bote)	1 Spray 15 Paneles	-

Complementos opcionales para la instalación / Optional materials for installation

Complementos opcionales para la instalación / Optional materials for installation	Rendimiento Aprox. / Average Usage	Precio / Price
○ MSA-3 Masilla de Pegado	1 Cartucho 4-5 Paneles	-
● PTE-31 Pintura Envejecido Piel	1 Spray 15 Paneles	-
● PTE-36 Pintura Envejecido Rojizo	1 Spray 15 Paneles	-

PRODUCTO PRODUCT	COD.	DESCRIPCIÓN DESCRIPTION	KG			PR	€/unidad
PR	12	Panel M. Regular Blanco Arena	PR: 6-7 kg	PR: 4 un	PR: 48 un	-	-
	12-E	Ángulo M. Regular Blanco Arena	PR: 2-3 kg	PR: 4 un	PR: 60 un	-	-

Complementos necesarios para la instalación / Necessary materials for installation

Complementos necesarios para la instalación / Necessary materials for installation	Rendimiento Aprox. / Average Usage	Precio / Price
● MSA-10 Masilla Juntas Beige	1 Cartucho 2-3 Paneles	-
● PTX-01 Pintura Beige Pizarra	1 Spray 8 Paneles	-
● PTE-21 Pintura Envejecido Marrón	1 Spray 15 Paneles	-

Complementos opcionales para la instalación / Optional materials for installation

Complementos opcionales para la instalación / Optional materials for installation	Rendimiento Aprox. / Average Usage	Precio / Price
○ MSA-3 Masilla de Pegado	1 Cartucho 4-5 Paneles	-
● PTE-24 Pintura Envejecido Rojo	1 Spray 15 Paneles	-

PRODUCTO PRODUCT	COD.	DESCRIPCIÓN DESCRIPTION	KG			PR	€/unidad
PR	13	Panel M. Regular Blanco Italia	PR: 6-7 kg	PR: 3 un	PR: 36 un	-	-
	13-E	Ángulo M. Regular Blanco Italia	PR: 2-3 kg	PR: 3 un	PR: 45 un	-	-

Complementos necesarios para la instalación / Necessary materials for installation

Complementos necesarios para la instalación / Necessary materials for installation	Rendimiento Aprox. / Average Usage	Precio / Price
○ MSA-70 Masilla Juntas Blanco Italia	1 Cartucho 2-3 Paneles	-
○ PTX-20 Pintura Blanco Italia	1 Spray 8 Paneles	-
● PTE-22 Pintura Envejecido Gris	1 Spray 15 Paneles	-

Complementos opcionales para la instalación / Optional materials for installation

Complementos opcionales para la instalación / Optional materials for installation	Rendimiento Aprox. / Average Usage	Precio / Price
○ MSA-3 Masilla de Pegado	1 Cartucho 4-5 Paneles	-
● PTE-24 Pintura Envejecido Rojo	1 Spray 15 Paneles	-

Classic
PIEDRA
ÁRIDA

PANELPIEDRA®

PR

HD



PR 120 Ocre



PR 122 Combinado

PR 120 Ocre



Classic PIEDRA ÁRIDA

ACABADOS / FINISHES



120

Ocre / Ochre

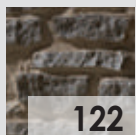

122

Combinado /
Two Tone

MEDIDAS / MEASUREMENTS

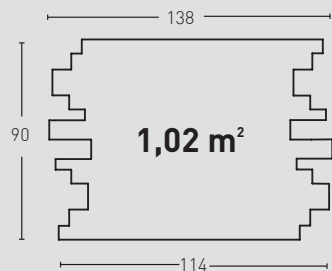

2 mín.
4 máx.



PRODUCTO PRODUCT	COD.	DESCRIPCIÓN DESCRIPTION	KG			PR	HD
PR HD	120	Panel Piedra Árida Ocre	PR: 6-7kg / HD: 30kg	PR:3un / HD:25un	PR:36un / HD:25un	-	-

Complementos necesarios para la instalación / Necessary materials for installation



- MSA-10 Masilla Juntas Beige
- PTX-60 Pintura Junta Medio
- PTE-21 Pintura Envejecido Marrón

Rendimiento Aprox. / Average Usage

- 1 Cartucho 2-3 Paneles
- 1 Spray 8 Paneles
- 1 Spray 15 Paneles

Precio / Price

-
-
-

Complementos opcionales para la instalación / Optional materials for installation



- MSA-3 Masilla de Pegado
- PTE-38 Pintura Ocre III
- PTE-31 Pintura Envejecido Piel

Rendimiento Aprox. / Average Usage

- 1 Cartucho 4-5 Paneles
- 1 Spray 15 Paneles
- 1 Spray 15 Paneles

Precio / Price

-
-
-

PRODUCTO PRODUCT	COD.	DESCRIPCIÓN DESCRIPTION	KG			PR	HD
PR HD	122	Panel Piedra Árida Combinado	PR: 6-7kg / HD: 30kg	PR:3un / HD:25un	PR:36un / HD:25un	-	-

Complementos necesarios para la instalación / Necessary materials for installation



- MSA-10 Masilla Juntas Beige
- PTX-60 Pintura Junta Medio
- PTE-21 Pintura Envejecido Marrón

Rendimiento Aprox. / Average Usage

- 1 Cartucho 2-3 Paneles
- 1 Spray 8 Paneles
- 1 Spray 15 Paneles

Precio / Price

-
-
-

Complementos opcionales para la instalación / Optional materials for installation



- MSA-3 Masilla de Pegado
- PTX-36 Pintura Gris I
- PTX-37 Pintura Gris II

Rendimiento Aprox. / Average Usage

- 1 Cartucho 4-5 Paneles
- 1 Spray 15 Paneles
- 1 Spray 15 Paneles

Precio / Price

-
-
-

Classic
MAMPOSTERÍA
RENACIMIENTO

PANELPIEDRA®

PR



PR 110 Ocre



PR 110 Ocre



Classic MAMPOSTERÍA RENACIMIENTO

ACABADOS / FINISHES



110

Ocre / Ochre

MEDIDAS / MEASUREMENTS

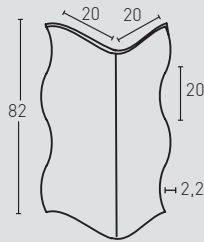
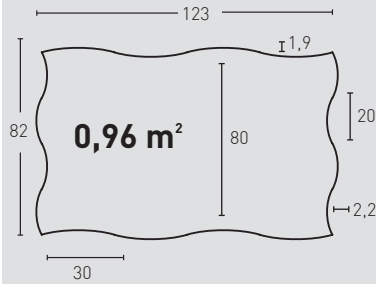

1,5 mín.
3 máx.



PRODUCTO PRODUCT	COD.	DESCRIPCIÓN DESCRIPTION				PR	€/unidad
PR	110 110-E	Panel M. Renacimiento Ocre Ángulo M. Renacimiento Ocre	PR: 6-7 kg PR: 2-3 kg	PR: 3 un PR: 2 un	PR: 36 un PR: 30 un	- -	- -
Complementos necesarios para la instalación / Necessary materials for installation				Rendimiento Aprox. / Average Usage		Precio / Price	
	<input type="checkbox"/>	MSA-70 Masilla Juntas Blanco Italia		1 Cartucho 2-3 Paneles		-	
	<input type="checkbox"/>	PTX-05 Pintura Beige Piedra		1 Spray 8 Paneles		-	
	<input type="checkbox"/>	PTE-21 Pintura Envejecido Marrón		1 Spray 15 Paneles		-	
	<input type="checkbox"/>	PTX-17 Pintura Juntas Verdoso		1 Spray 15 Paneles		-	
Complementos opcionales para la instalación / Optional materials for installation				Rendimiento Aprox. / Average Usage		Precio / Price	
	<input type="checkbox"/>	MSA-3 Masilla de Pegado		1 Cartucho 4-5 Paneles		-	
	<input type="checkbox"/>	PTE-36 Pintura Envejecido Rojizo		1 Spray 15 Paneles		-	
	<input type="checkbox"/>	PTE-26 Pintura Envejecido Ocre		1 Spray 15 Paneles		-	
	<input type="checkbox"/>	PTE-33 Pintura Envejecido Caleado + Compó (Bote)		1 Spray 15 Paneles		-	

Classic
PIEDRA
DE ADOBE

PANELPIEDRA®

PR



PR 140 Ocre



PR 142 Combinado



PR 140 Ocre

Classic PIEDRA DE ADOBE

ACABADOS / FINISHES



140
Ocre / Ochre

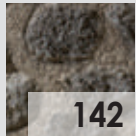

142
Combinado /
Two Tone

MEDIDAS / MEASUREMENTS

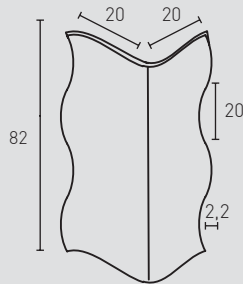
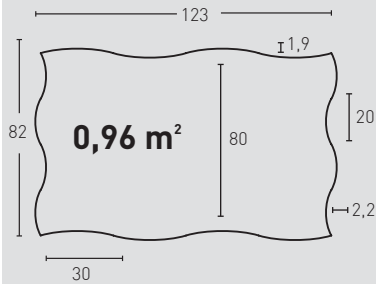

1,5 mín.
3 máx.



PRODUCTO PRODUCT	COD.	DESCRIPCIÓN DESCRIPTION	KG			PR	€/unidad
PR	140	Panel Piedra de Adobe Ocre	PR: 7-8 kg	PR: 3 un	PR: 36 un	-	-
	140-E	Ángulo Piedra de Adobe Ocre	PR: 2-3 kg	PR: 2 un	PR: 30 un	-	-

Complementos necesarios para la instalación / Necessary materials for installation



- MSA-10 Masilla Juntas Beige
- PTX-60 Pintura Junta Medio
- PTE-21 Pintura Envejecido Marrón

Rendimiento Aprox. / Average Usage

- 1 Cartucho 2-3 Paneles
- 1 Spray 8 Paneles
- 1 Spray 15 Paneles

Precio / Price

-
-
-

Complementos opcionales para la instalación / Optional materials for installation



- MSA-3 Masilla de Pegado
- PTX-38 Pintura Ocre III
- PTX-31 Pintura Óxido Amarillo

Rendimiento Aprox. / Average Usage

- 1 Cartucho 4-5 Paneles
- 1 Spray 15 Paneles
- 1 Spray 15 Paneles

Precio / Price

-
-
-

PRODUCTO PRODUCT	COD.	DESCRIPCIÓN DESCRIPTION	KG			PR	€/unidad
PR	142	P. Piedra de Adobe Combinado	PR: 7-8 kg	PR: 3 un	PR: 36 un	-	-
	142-E	Áng. Pied. de Adobe Combinado	PR: 2-3 kg	PR: 2 un	PR: 30 un	-	-

Complementos necesarios para la instalación / Necessary materials for installation



- MSA-10 Masilla Juntas Beige
- PTX-60 Pintura Junta Medio
- PTE-21 Pintura Envejecido Marrón

Rendimiento Aprox. / Average Usage

- 1 Cartucho 2-3 Paneles
- 1 Spray 8 Paneles
- 1 Spray 15 Paneles

Precio / Price

-
-
-

Complementos opcionales para la instalación / Optional materials for installation



- MSA-3 Masilla de Pegado
- PTE-36 Pintura Envejecido Rojizo
- PTE-37 Pintura Envejecido Marrón Oscuro

Rendimiento Aprox. / Average Usage

- 1 Cartucho 4-5 Paneles
- 1 Spray 15 Paneles
- 1 Spray 15 Paneles

Precio / Price

-
-
-

Classic PIRINEOS

PANELPIEDRA®

PR



PR 57 Gris Oscuro combinado



PR 56 Blanco Italia

PR 59 Gris Claro combinado



Classic PIRINEOS

ACABADOS / FINISHES



56
Blanco Italia /
Italian White

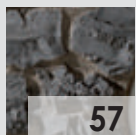

57
Gris Oscuro Combinado /
Two Dark Tone

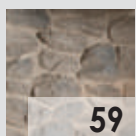

59
Gris Claro Combinado /
Two Light Tone

MEDIDAS / MEASUREMENTS

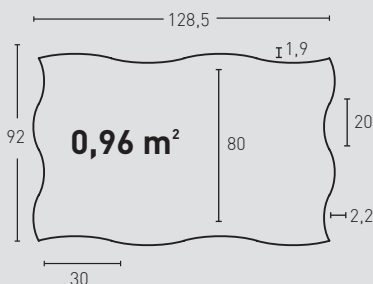

1 mín.
3,5 máx.



PRODUCTO PRODUCT	COD.	DESCRIPCIÓN DESCRIPTION	KG			PR	€/unidad
PR	56	Panel Pirineos Blanco Italia	PR: 8-9 kg	PR: 2 un	PR: 24 un	-	

Complementos necesarios para la instalación / Necessary materials for installation

Complementos necesarios para la instalación / Necessary materials for installation	Rendimiento Aprox. / Average Usage	Precio / Price
● MSA-10 Masilla Juntas Beige	1 Cartucho 2-3 Paneles	-
● PTX-01 Pintura Beige Pizarra	1 Spray 8 Paneles	-
● PTE-21 Pintura Envejecido Marrón	1 Spray 15 Paneles	-

Complementos opcionales para la instalación / Optional materials for installation

Complementos opcionales para la instalación / Optional materials for installation	Rendimiento Aprox. / Average Usage	Precio / Price
○ MSA-3 Masilla de Pegado	1 Cartucho 4-5 Paneles	-
● PTE-24 Pintura Envejecido Rojo	1 Spray 15 Paneles	-
○ PTX-20 Pintura Blanco Italia	1 Spray 15 Paneles	-

PRODUCTO PRODUCT	COD.	DESCRIPCIÓN DESCRIPTION	KG			PR	€/unidad
PR	57	Panel Pirineos Gris Oscuro Combinado	PR: 8-9 kg	PR: 2 un	PR: 24 un	-	

Complementos necesarios para la instalación / Necessary materials for installation

Complementos necesarios para la instalación / Necessary materials for installation	Rendimiento Aprox. / Average Usage	Precio / Price
● MSA-10 Masilla Juntas Beige	1 Cartucho 2-3 Paneles	-
● PTX-60 Pintura Junta Medio	1 Spray 8 Paneles	-
● PTE-21 Pintura Envejecido Marrón	1 Spray 15 Paneles	-

Complementos opcionales para la instalación / Optional materials for installation

Complementos opcionales para la instalación / Optional materials for installation	Rendimiento Aprox. / Average Usage	Precio / Price
○ MSA-3 Masilla de Pegado	1 Cartucho 4-5 Paneles	-
● PTX-36 Pintura Gris I	1 Spray 15 Paneles	-
● PTX-37 Pintura Gris II	1 Spray 15 Paneles	-

PRODUCTO PRODUCT	COD.	DESCRIPCIÓN DESCRIPTION	KG			PR	€/unidad
PR	59	Panel Pirineos Gris Claro Combinado	PR: 8-9 kg	PR: 2 un	PR: 24 un	-	

Complementos necesarios para la instalación / Necessary materials for installation

Complementos necesarios para la instalación / Necessary materials for installation	Rendimiento Aprox. / Average Usage	Precio / Price
● MSA-10 Masilla Juntas Beige	1 Cartucho 2-3 Paneles	-
● PTX-60 Pintura Junta Medio	1 Spray 8 Paneles	-
● PTE-21 Pintura Envejecido Marrón	1 Spray 15 Paneles	-

Complementos opcionales para la instalación / Optional materials for installation

Complementos opcionales para la instalación / Optional materials for installation	Rendimiento Aprox. / Average Usage	Precio / Price
○ MSA-3 Masilla de Pegado	1 Cartucho 4-5 Paneles	-
● PTX-53 Pintura Gris Claro	1 Spray 15 Paneles	-
● PTX-37 Pintura Gris II	1 Spray 15 Paneles	-

Classic CUBIC

PANELPIEDRA®

PR

HD



PR 302 Antracita



PR 301 Blanco Italia

PR 302 Antracita



Classic CUBIC

ACABADOS / FINISHES



300
Ocre / Ochre



301
Blanco Italia / Italian White

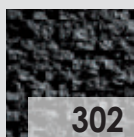

302
Antracita / Anthracite

MEDIDAS / MEASUREMENTS

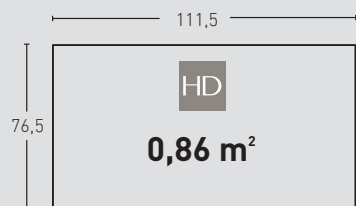
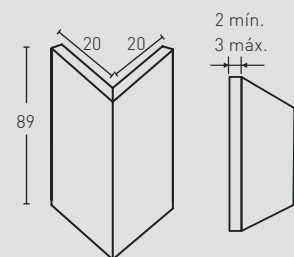
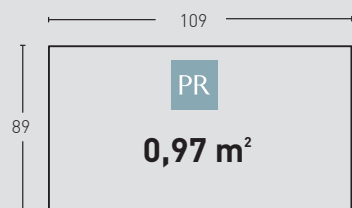

PRODUCTO PRODUCT	COD.	DESCRIPCIÓN DESCRIPTION				PR	HD
	300 300-E	Panel Cubic Ocre Ángulo Cubic Ocre	PR: 6-7 kg / HD:15-20kg PR: 2-3 kg	PR: 4 un PR: 4 un	PR: 48 un PR: 60 un	-	-

Complementos necesarios para la instalación / Necessary materials for installation

Complementos necesarios para la instalación / Necessary materials for installation	Rendimiento Aprox. / Average Usage	Precio / Price
MSA-70 Masilla Juntas Blanco Italia	1 Cartucho 4 Paneles	-
PTX-05 Pintura Beige Piedra	1 Spray 8 Paneles	-
PTE-26 Pintura Envejecido Ocre	1 Spray 15 Paneles	-

Complementos opcionales para la instalación / Optional materials for installation

Complementos opcionales para la instalación / Optional materials for installation	Rendimiento Aprox. / Average Usage	Precio / Price
MSA-3 Masilla de Pegado	1 Cartucho 4-5 Paneles	-
PTE-35 Pintura Envejecido Óxido	1 Spray 25 Paneles	-

PRODUCTO PRODUCT	COD.	DESCRIPCIÓN DESCRIPTION				PR	HD
	301 301-E	Panel Cubic Blanco Italia Ángulo Cubic Blanco Italia	PR: 6-7 kg PR: 2-3 kg	PR: 4 un PR: 4 un	PR: 48 un PR: 60 un	-	-

Complementos necesarios para la instalación / Necessary materials for installation

Complementos necesarios para la instalación / Necessary materials for installation	Rendimiento Aprox. / Average Usage	Precio / Price
MSA-70 Masilla Juntas Blanco Italia	1 Cartucho 4 Paneles	-
PTX-20 Pintura Blanco Italia	1 Spray 8 Paneles	-

Complementos opcionales para la instalación / Optional materials for installation

Complementos opcionales para la instalación / Optional materials for installation	Rendimiento Aprox. / Average Usage	Precio / Price
MSA-3 Masilla de Pegado	1 Cartucho 4-5 Paneles	-
PTE-22 Pintura Envejecido Gris	1 Spray 15 Paneles	-

PRODUCTO PRODUCT	COD.	DESCRIPCIÓN DESCRIPTION				PR	HD
	302 302-E	Panel Cubic Antracita Ángulo Cubic Antracita	PR: 6-7 kg PR: 2-3 kg	PR: 4 un PR: 4 un	PR: 48 un PR: 60 un	-	-

Complementos necesarios para la instalación / Necessary materials for installation

Complementos necesarios para la instalación / Necessary materials for installation	Rendimiento Aprox. / Average Usage	Precio / Price
MSA-60 Masilla Juntas Antracita	1 Cartucho 2-3 Paneles	-
PTX-19 Pintura Antracita	1 Spray 6 Paneles	-

Complementos opcionales para la instalación / Optional materials for installation

Complementos opcionales para la instalación / Optional materials for installation	Rendimiento Aprox. / Average Usage	Precio / Price
MSA-3 Masilla de Pegado	1 Cartucho 4-5 Paneles	-

Las medidas pueden variar +/-1cm / Measurements may vary +/-1cm

* Consultar fecha de entrega / Consult delivery date

Classic GRAN CUBIC

PANELPIEDRA®

PR



PR 340 Ocre



PR 341 Blanco Italia



Classic GRAN CUBIC

ACABADOS / FINISHES

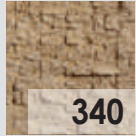

340
Ochre / Ochre

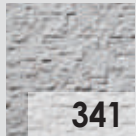

341
Blanco Italia / Italian White

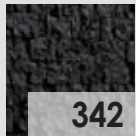

342
Antracita / Anthracite

MEDIDAS / MEASUREMENTS

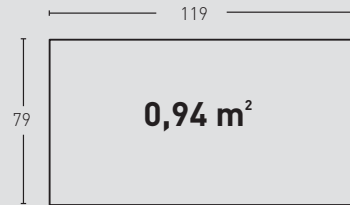

2 mín.
3 máx.



PRODUCTO PRODUCT	COD.	DESCRIPCIÓN DESCRIPTION	KG			PR	€/unidad
PR	340	Panel Gran Cubic Ochre	PR: 6-7 kg	PR: 4 un	PR: 48 un	-	-

Complementos necesarios para la instalación / Necessary materials for installation

Complementos necesarios para la instalación / Necessary materials for installation	Rendimiento Aprox. / Average Usage	Precio / Price
MSA-70 Masilla Juntas Blanco Italia PTX-05 Pintura Beige Piedra PTE-26 Pintura Envejecido Ochre	1 Cartucho 4 Paneles 1 Spray 8 Paneles 1 Spray 15 Paneles	-

Complementos opcionales para la instalación / Optional materials for installation

Complementos opcionales para la instalación / Optional materials for installation	Rendimiento Aprox. / Average Usage	Precio / Price
MSA-3 Masilla de Pegado PTE-35 Pintura Envejecido Óxido	1 Cartucho 4-5 Paneles 1 Spray 15 Paneles	-

PRODUCTO PRODUCT	COD.	DESCRIPCIÓN DESCRIPTION	KG			PR	€/unidad
PR	341	Panel Gran Cubic Blanco Italia	PR: 6-7 kg	PR: 4 un	PR: 48 un	-	-

Complementos necesarios para la instalación / Necessary materials for installation

Complementos necesarios para la instalación / Necessary materials for installation	Rendimiento Aprox. / Average Usage	Precio / Price
MSA-70 Masilla Juntas Blanco Italia PTX-20 Pintura Blanco Italia	1 Cartucho 4 Paneles 1 Spray 8 Paneles	-

Complementos opcionales para la instalación / Optional materials for installation

Complementos opcionales para la instalación / Optional materials for installation	Rendimiento Aprox. / Average Usage	Precio / Price
MSA-3 Masilla de Pegado PTE-22 Pintura Envejecido Gris	1 Cartucho 4-5 Paneles 1 Spray 15 Paneles	-

PRODUCTO PRODUCT	COD.	DESCRIPCIÓN DESCRIPTION	KG			PR	€/unidad
PR	342	Panel Gran Cubic Antracita	PR: 6-7 kg	PR: 4 un	PR: 48 un	-	-

Complementos necesarios para la instalación / Necessary materials for installation

Complementos necesarios para la instalación / Necessary materials for installation	Rendimiento Aprox. / Average Usage	Precio / Price
MSA-60 Masilla Juntas Antracita PTX-19 Pintura Antracita	1 Cartucho 4 Paneles 1 Spray 6 Paneles	-

Complementos opcionales para la instalación / Optional materials for installation

Complementos opcionales para la instalación / Optional materials for installation	Rendimiento Aprox. / Average Usage	Precio / Price
MSA-3 Masilla de Pegado	1 Cartucho 4-5 Paneles	-

Classic INSPIRATION

PANELPIEDRA®

PR



PR 311 Blanco Italia



PR 310 Ocre

PR 311 Blanco Italia

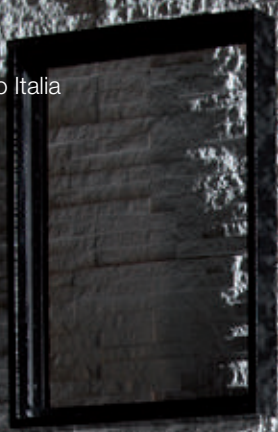

Classic INSPIRATION

ACABADOS / FINISHES

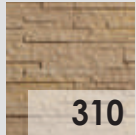

310
Ochre / Ochre



311
Blanco Italia / Italian White

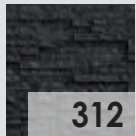

312
Antracita / Anthracite

MEDIDAS / MEASUREMENTS

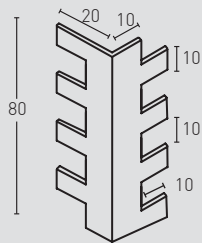
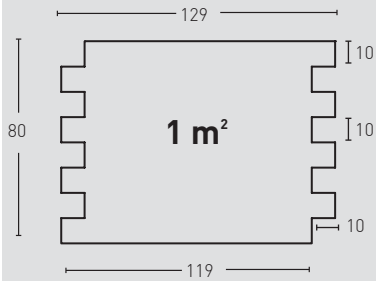

1,5 mín.
3 máx.



PRODUCTO PRODUCT	COD.	DESCRIPCIÓN DESCRIPTION				PR
PR	310 310-E	Panel Inspiration Ochre Ángulo Inspiration Ochre	PR: 6-7 kg	PR: 4 un	PR: 48 un	€/unidad
			PR: 2-3 kg	PR: 4 un	PR: 60 un	-

Complementos necesarios para la instalación / Necessary materials for installation			Rendimiento Aprox. / Average Usage		Precio / Price
	<input type="checkbox"/> MSA-70 Masilla Juntas Blanco Italia		1 Cartucho 2-3 Paneles	-	
	<input type="checkbox"/> PTX-05 Pintura Beige Piedra		1 Spray 8 Paneles	-	
	<input type="checkbox"/> PTE-26 Pintura Envejecido Ochre		1 Spray 15 Paneles	-	

Complementos opcionales para la instalación / Optional materials for installation			Rendimiento Aprox. / Average Usage		Precio / Price
	<input type="checkbox"/> MSA-3 Masilla de Pegado		1 Cartucho 4-5 Paneles	-	
	<input type="checkbox"/> PTE-35 Pintura Envejecido Óxido		1 Spray 15 Paneles	-	

PRODUCTO PRODUCT	COD.	DESCRIPCIÓN DESCRIPTION				PR
PR	311 311-E	Panel Inspiration Blanco Italia Ángulo Inspiration Blanco Italia	PR: 6-7 kg	PR: 4 un	PR: 48 un	€/unidad
			PR: 2-3 kg	PR: 4 un	PR: 60 un	-

Complementos necesarios para la instalación / Necessary materials for installation			Rendimiento Aprox. / Average Usage		Precio / Price
	<input type="checkbox"/> MSA-70 Masilla Juntas Blanco Italia		1 Cartucho 3-4 Paneles	-	
	<input type="checkbox"/> PTX-20 Pintura Blanco Italia		1 Spray 8 Paneles	-	

Complementos opcionales para la instalación / Optional materials for installation			Rendimiento Aprox. / Average Usage		Precio / Price
	<input type="checkbox"/> MSA-3 Masilla de Pegado		1 Cartucho 4-5 Paneles	-	
	<input checked="" type="checkbox"/> PTE-22 Pintura Envejecido Gris		1 Spray 15 Paneles	-	

PRODUCTO PRODUCT	COD.	DESCRIPCIÓN DESCRIPTION				PR
PR	312 312-E	Panel Inspiration Antracita Ángulo Inspiration Antracita	PR: 6-7 kg	PR: 4 un	PR: 48 un	€/unidad
			PR: 2-3 kg	PR: 4 un	PR: 60 un	-

Complementos necesarios para la instalación / Necessary materials for installation			Rendimiento Aprox. / Average Usage		Precio / Price
	<input checked="" type="checkbox"/> MSA-60 Masilla Juntas Antracita		1 Cartucho 3-4 Paneles	-	
	<input checked="" type="checkbox"/> PTX-19 Pintura Antracita		1 Spray 6 Paneles	-	

Complementos opcionales para la instalación / Optional materials for installation			Rendimiento Aprox. / Average Usage		Precio / Price
	<input type="checkbox"/> MSA-3 Masilla de Pegado		1 Cartucho 4-5 Paneles	-	

Classic DELUXE

PANELPIEDRA®

PR

HD



PR 360 Ocre



PR 362 Antracita



Classic DELUXE

ACABADOS / FINISHES



360
Ocre / Ochre



361
Blanco Italia / Italian White

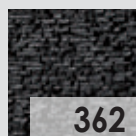

362
Antracita / Anthracite

MEDIDAS / MEASUREMENTS

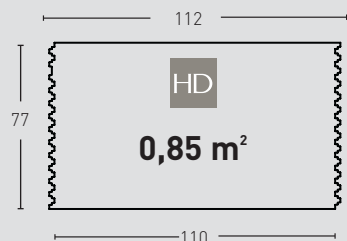
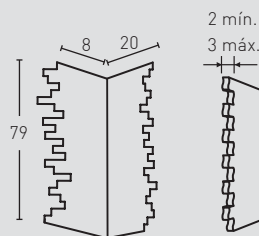
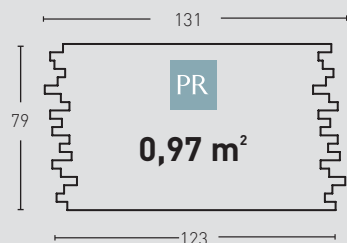

Las medidas pueden variar +/-1cm / Measurements may vary +/-1cm

PRODUCTO PRODUCT	COD.	DESCRIPCIÓN DESCRIPTION	KG			PR	HD
PR HD	360 360-E	Panel Deluxe Ocre Ángulo Deluxe Ocre	PR 6-7kg / HD:15-20kg PR: 2-3 kg	PR: 4un / HD: 25un PR: 4 un	PR:48un / HD:25un PR: 60 un	-	-
						€/unidad	
						-	-
						-	* consultar

Complementos necesarios para la instalación / Necessary materials for installation

Complementos necesarios para la instalación / Necessary materials for installation	Rendimiento Aprox. / Average Usage	Precio / Price
MSA-70 Masilla Juntas Blanco Italia	1 Cartucho 3-4 Paneles	-
PTX-05 Pintura Beige Piedra	1 Spray 8 Paneles	-
PTE-26 Pintura Envejecido Ocre	1 Spray 15 Paneles	-

Complementos opcionales para la instalación / Optional materials for installation

Complementos opcionales para la instalación / Optional materials for installation	Rendimiento Aprox. / Average Usage	Precio / Price
MSA-3 Masilla de Pegado	1 Cartucho 4-5 Paneles	-
PTE-35 Pintura Envejecido Óxido	1 Spray 15 Paneles	-

PRODUCTO PRODUCT	COD.	DESCRIPCIÓN DESCRIPTION	KG			PR	HD
PR HD	361 361-E	Panel Deluxe Blanco Italia Ángulo Deluxe Blanco Italia	PR 6-7kg / HD:15-20kg PR: 2-3 kg	PR: 4un / HD: 25un PR: 4 un	PR:48un / HD:25un PR: 60 un	-	-
						€/unidad	
						-	-
						-	* consultar

Complementos necesarios para la instalación / Necessary materials for installation

Complementos necesarios para la instalación / Necessary materials for installation	Rendimiento Aprox. / Average Usage	Precio / Price
MSA-70 Masilla Juntas Blanco Italia	1 Cartucho 3-4 Paneles	-
PTX-20 Pintura Blanco Italia	1 Spray 8 Paneles	-

Complementos opcionales para la instalación / Optional materials for installation

Complementos opcionales para la instalación / Optional materials for installation	Rendimiento Aprox. / Average Usage	Precio / Price
MSA-3 Masilla de Pegado	1 Cartucho 4-5 Paneles	-
PTE-22 Pintura Envejecido Gris	1 Spray 15 Paneles	-

PRODUCTO PRODUCT	COD.	DESCRIPCIÓN DESCRIPTION	KG			PR	HD
PR HD	362 362-E	Panel Deluxe Antracita Ángulo Deluxe Antracita	PR 6-7kg / HD:15-20kg PR: 2-3 kg	PR: 4un / HD: 25un PR: 4 un	PR:48un / HD:25un PR: 60 un	-	-
						€/unidad	
						-	-
						-	* consultar

Complementos necesarios para la instalación / Necessary materials for installation

Complementos necesarios para la instalación / Necessary materials for installation	Rendimiento Aprox. / Average Usage	Precio / Price
MSA-60 Masilla Juntas Antracita	1 Cartucho 3-4 Paneles	-
PTX-19 Pintura Antracita	1 Spray 6 Paneles	-

Complementos opcionales para la instalación / Optional materials for installation

Complementos opcionales para la instalación / Optional materials for installation	Rendimiento Aprox. / Average Usage	Precio / Price
MSA-3 Masilla de Pegado	1 Cartucho 4-5 Paneles	-

* Consultar fecha de entrega / Consult delivery date

Classic PREMIER

PANELPIEDRA®

PR

HD



PR 372 Antracita



PR 372 Antracita



PR 371 Blanco Italia

Classic PREMIER

ACABADOS / FINISHES

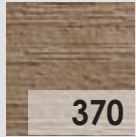

370
Ocre / Ochre

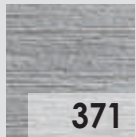

371
Blanco Italia / Italian White

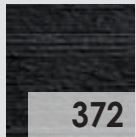

372
Antracita / Anthracite

MEDIDAS / MEASUREMENTS

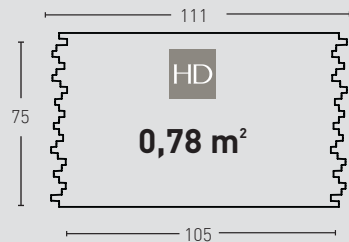
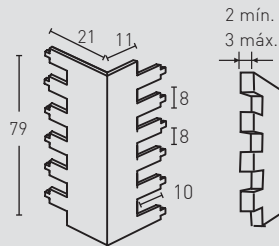
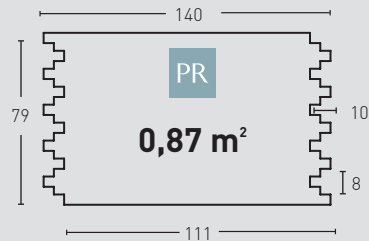

PRODUCTO PRODUCT	COD.	DESCRIPCIÓN DESCRIPTION				PR	HD
	370 370-E	Panel Premier Ocre Ángulo Premier Ocre	PR 6-7kg / HD:15-20kg PR: 2-3 kg	PR: 5un / HD: 25un PR: 4 un	PR:60un / HD:25un PR: 60 un	-	-

Complementos necesarios para la instalación / Necessary materials for installation			Rendimiento Aprox. / Average Usage		Precio / Price	
	<input type="checkbox"/> MSA-70 Masilla Juntas Blanco Italia		1 Cartucho 3-4 Paneles	-	-	-
	<input type="checkbox"/> PTX-05 Pintura Beige Piedra		1 Spray 8 Paneles	-	-	-
	<input type="checkbox"/> PTE-26 Pintura Envejecido Ocre		1 Spray 15 Paneles	-	-	-
Complementos opcionales para la instalación / Optional materials for installation			Rendimiento Aprox. / Average Usage		Precio / Price	
	<input type="checkbox"/> MSA-3 Masilla de Pegado		1 Cartucho 4-5 Paneles	-	-	-
	<input type="checkbox"/> PTE-35 Pintura Envejecido Óxido		1 Spray 15 Paneles	-	-	-

PRODUCTO PRODUCT	COD.	DESCRIPCIÓN DESCRIPTION				PR	HD
	371 371-E	Panel Premier Blanco Italia Ángulo Premier Blanco Italia	PR 6-7kg / HD:15-20kg PR: 2-3 kg	PR: 5un / HD: 25un PR: 4 un	PR:60un / HD:25un PR: 60 un	-	-

Complementos necesarios para la instalación / Necessary materials for installation			Rendimiento Aprox. / Average Usage		Precio / Price	
	<input type="checkbox"/> MSA-70 Masilla Juntas Blanco Italia		1 Cartucho 3-4 Paneles	-	-	-
	<input type="checkbox"/> PTX-20 Pintura Blanco Italia		1 Spray 8 Paneles	-	-	-
Complementos opcionales para la instalación / Optional materials for installation			Rendimiento Aprox. / Average Usage		Precio / Price	
	<input type="checkbox"/> MSA-3 Masilla de Pegado		1 Cartucho 4-5 Paneles	-	-	-
	<input checked="" type="checkbox"/> PTE-22 Pintura Envejecido Gris		1 Spray 15 Paneles	-	-	-

PRODUCTO PRODUCT	COD.	DESCRIPCIÓN DESCRIPTION				PR	HD
	372 372-E	Panel Premier Antracita Ángulo Premier Antracita	PR 6-7kg / HD:15-20kg PR: 2-3 kg	PR: 5un / HD: 25un PR: 4 un	PR:60un / HD:25un PR: 60 un	-	-

Complementos necesarios para la instalación / Necessary materials for installation			Rendimiento Aprox. / Average Usage		Precio / Price	
	<input checked="" type="checkbox"/> MSA-60 Masilla Juntas Antracita		1 Cartucho 3-4 Paneles	-	-	-
	<input checked="" type="checkbox"/> PTX-19 Pintura Antracita		1 Spray 6 Paneles	-	-	-
Complementos opcionales para la instalación / Optional materials for installation			Rendimiento Aprox. / Average Usage		Precio / Price	
	<input type="checkbox"/> MSA-3 Masilla de Pegado		1 Cartucho 4-5 Paneles	-	-	-

Las medidas pueden variar +/-1cm / Measurements may vary +/-1cm

* Consultar fecha de entrega / Consult delivery date

Classic EMPHASIS

PANELPIEDRA®

PR

HD



PR 400 Ocre



PR 401 Blanco Italia

PR 400 Ocre

Classic EMPHASIS

ACABADOS / FINISHES

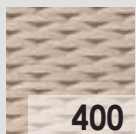

400
Ochre / Ochre

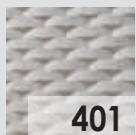

401
Blanco Italia / Italian White

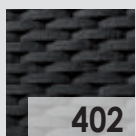

402
Antracita / Anthracite

MEDIDAS / MEASUREMENTS

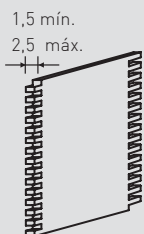
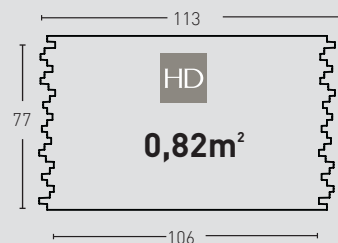
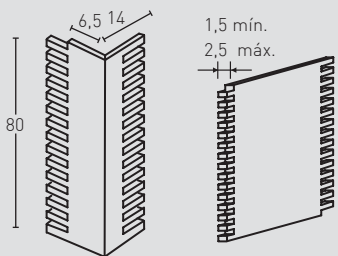
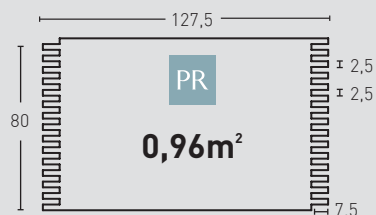

Las medidas pueden variar +/-1cm / Measurements may vary +/-1cm

PRODUCTO PRODUCT	COD.	DESCRIPCIÓN DESCRIPTION	KG			PR	HD
PR HD	400 400-E	Panel Emphasis Ochre Ángulo Emphasis Ochre	PR 6-7kg / HD:15-20kg PR: 2-3 kg	PR: 6un / HD: 25un PR: 4 un	PR:72un / HD:25un PR: 60 un	-	-
						€/unidad	
						-	-
						-	* consultar

Complementos necesarios para la instalación / Necessary materials for installation



- MSA-70 Masilla Juntas Blanco Italia
- PTX-05 Pintura Beige Piedra
- PTE-26 Pintura Envejecido Ochre

Rendimiento Aprox. / Average Usage

- 1 Cartucho 3-4 Paneles
- 1 Spray 8 Paneles
- 1 Spray 15 Paneles

Precio / Price

-
-
-

Complementos opcionales para la instalación / Optional materials for installation



- MSA-3 Masilla de Pegado

Rendimiento Aprox. / Average Usage

- 1 Cartucho 4-5 Paneles

Precio / Price

-

PRODUCTO PRODUCT	COD.	DESCRIPCIÓN DESCRIPTION	KG			PR	HD
PR HD	401 401-E	Panel Emphasis Blanco Italia Ángulo Emphasis Blanco Italia	PR 6-7kg / HD:15-20kg PR: 2-3 kg	PR: 6un / HD: 25un PR: 4 un	PR:72un / HD:25un PR: 60 un	-	-
						€/unidad	
						-	-
						-	* consultar

Complementos necesarios para la instalación / Necessary materials for installation



- MSA-70 Masilla Juntas Blanco Italia
- PTX-20 Pintura Blanco Italia

Rendimiento Aprox. / Average Usage

- 1 Cartucho 3-4 Paneles
- 1 Spray 8 Paneles

Precio / Price

-
-

Complementos opcionales para la instalación / Optional materials for installation



- MSA-3 Masilla de Pegado
- PTE-22 Pintura Envejecido Gris

Rendimiento Aprox. / Average Usage

- 1 Cartucho 4-5 Paneles
- 1 Spray 15 Paneles

Precio / Price

-
-

PRODUCTO PRODUCT	COD.	DESCRIPCIÓN DESCRIPTION	KG			PR	HD
PR HD	402 402-E	Panel Emphasis Antracita Ángulo Emphasis Antracita	PR 6-7kg / HD:15-20kg PR: 2-3 kg	PR: 6un / HD: 25un PR: 4 un	PR:72un / HD:25un PR: 60 un	-	-
						€/unidad	
						-	-
						-	* consultar

Complementos necesarios para la instalación / Necessary materials for installation



- MSA-60 Masilla Juntas Antracita
- PTX-19 Pintura Antracita

Rendimiento Aprox. / Average Usage

- 1 Cartucho 3-4 Paneles
- 1 Spray 6 Paneles

Precio / Price

-
-

Complementos opcionales para la instalación / Optional materials for installation



- MSA-3 Masilla de Pegado

Rendimiento Aprox. / Average Usage

- 1 Cartucho 4-5 Paneles

Precio / Price

-

* Consultar fecha de entrega / Consult delivery date

Classic CONCEPT

PANELPIEDRA®

PR



PR 451 Blanco Italia



PR 452 Antracita

PR 451 Blanco Italia



Classic CONCEPT

ACABADOS / FINISHES

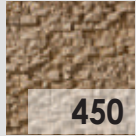

450
Ochre / Ochre

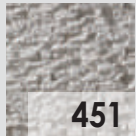

451
Blanco Italia / Italian White

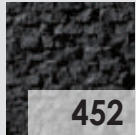

452
Antracita / Anthracite

MEDIDAS / MEASUREMENTS

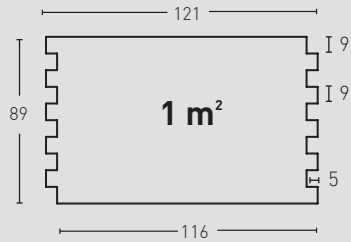

PRODUCTO PRODUCT	COD.	DESCRIPCIÓN DESCRIPTION				PR	€/unidad
PR	450	Panel Concept Ochre	PR: 6-7 kg	PR: 4 un	PR: 48 un	-	-

Complementos necesarios para la instalación / Necessary materials for installation			Rendimiento Aprox. / Average Usage		Precio / Price
	<input type="checkbox"/>	MSA-70 Masilla Juntas Blanco Italia	1	Cartucho 3-4 Paneles	-
	<input type="checkbox"/>	PTX-05 Pintura Beige Piedra	1	Spray 8 Paneles	-
	<input type="checkbox"/>	PTE-26 Pintura Envejecido Ochre	1	Spray 15 Paneles	-

Complementos opcionales para la instalación / Optional materials for installation			Rendimiento Aprox. / Average Usage		Precio / Price
	<input type="checkbox"/>	MSA-3 Masilla de Pegado	1	Cartucho 4-5 Paneles	-
	<input type="checkbox"/>	PTE-35 Pintura Envejecido Óxido	1	Spray 15 Paneles	-

PRODUCTO PRODUCT	COD.	DESCRIPCIÓN DESCRIPTION				PR	€/unidad
PR	451	Panel Concept Blanco Italia	PR: 6-7 kg	PR: 4 un	PR: 48 un	-	-

Complementos necesarios para la instalación / Necessary materials for installation			Rendimiento Aprox. / Average Usage		Precio / Price
	<input type="checkbox"/>	MSA-70 Masilla Juntas Blanco Italia	1	Cartucho 3-4 Paneles	-
	<input type="checkbox"/>	PTX-20 Pintura Blanco Italia	1	Spray 8 Paneles	-

Complementos opcionales para la instalación / Optional materials for installation			Rendimiento Aprox. / Average Usage		Precio / Price
	<input type="checkbox"/>	MSA-3 Masilla de Pegado	1	Cartucho 4-5 Paneles	-
	<input type="checkbox"/>	PTE-22 Pintura Envejecido Gris	1	Spray 15 Paneles	-

PRODUCTO PRODUCT	COD.	DESCRIPCIÓN DESCRIPTION				PR	€/unidad
PR	452	Panel Concept Antracita	PR: 6-7 kg	PR: 4 un	PR: 48 un	-	-

Complementos necesarios para la instalación / Necessary materials for installation			Rendimiento Aprox. / Average Usage		Precio / Price
	<input checked="" type="checkbox"/>	MSA-60 Masilla Juntas Antracita	1	Cartucho 3-4 Paneles	-
	<input checked="" type="checkbox"/>	PTX-19 Pintura Antracita	1	Spray 6 Paneles	-

Complementos opcionales para la instalación / Optional materials for installation			Rendimiento Aprox. / Average Usage		Precio / Price
	<input type="checkbox"/>	MSA-3 Masilla de Pegado	1	Cartucho 4-5 Paneles	-



MARKETING

MARKETING



CATÁLOGOS / 339



MUESTRAS / 340

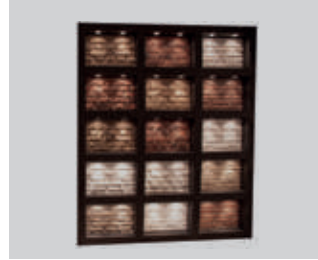

EXPOSITOR MECANO / 341-344

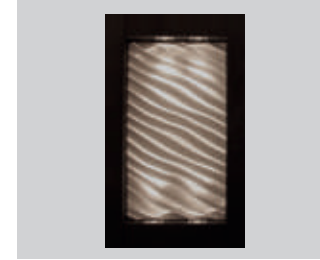

EXPOSIT. MODULAR / 345-346

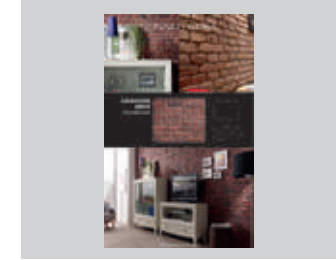





EXPOSITOR VINILO / 347-348

Marketing CATÁLOGOS

CAT-01

Catálogo-Tarifa /
Catalogue-Pricelist



COD.	DESCRIPCIÓN DESCRIPTION	 kg			 €/unidad
CAT-01	Catálogo-Tarifa 2022	0,8 kg	15 un	800 un	-
CAT-02	Catálogo 2022 (A4)	0,35 kg	24 un	800 un	-

CAT-02

Catálogo Contract /
Contract Catalogue



Marketing MUESTRAS

MU-01

Muestras / Samples



MU-02

Conjunto de 5 muestras /
Set 5 samples



MU-03

Conjunto de 10 muestras /
Set 10 samples



COD.	DESCRIPCIÓN DESCRIPTION	 KG			 €/unidad
MU-01	Muestra	0,2-1 kg	10 un	100 un	-
MU-02	Conjunto de 5 muestras	2-5 kg	10 un	100 un	-
MU-03	Conjunto de 10 muestras	4-9 kg	10 un	100 un	-

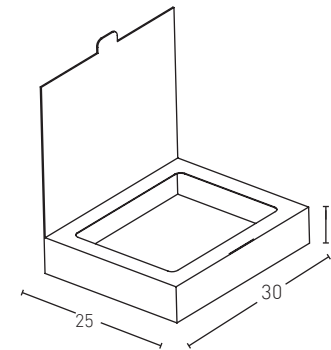

Marketing EXPOSITOR MECANO

EXPO-05

Expositor Mecano
5 muestras con luz /
Exhibitor Mecano
5 samples with lights

COD.	DESCRIPCIÓN DESCRIPTION	KG	CUB	UN	€/unidad
EXPO-05	Expositor Mecano 5 muestras con luz	40-50 kg	-	3 un	-

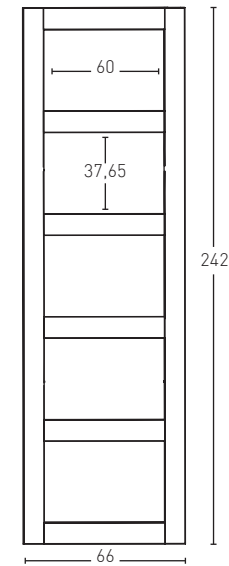
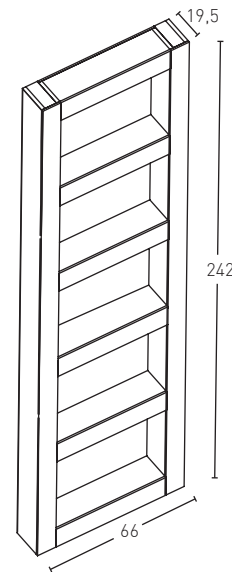

Marketing EXPOSITOR MECANO

EXPO-06

Expositor Mecano
10 muestras con luz /
Exhibitor Mecano
10 samples with lights



COD.	DESCRIPCIÓN DESCRIPTION	KG	Caja	Unidades	€/unidad
EXPO-06	Expositor Mecano 10 muestras con luz	100 kg	-	3 un	-

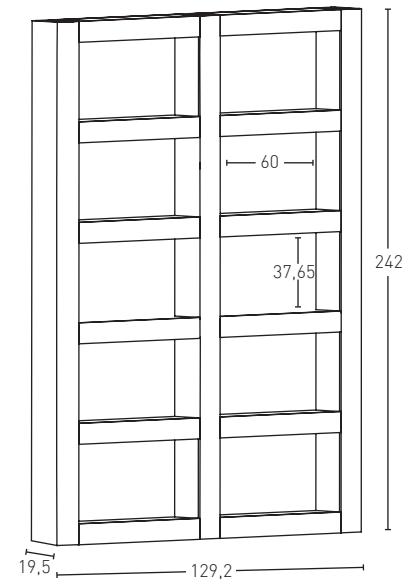

Marketing EXPOSITOR MECANO

EXPO-07

Expositor Mecano
15 muestras con luz /
Exhibitor Mecano
15 samples with lights

COD.	DESCRIPCIÓN DESCRIPTION	KG	CUB	UN	€/unidad
EXPO-07	Expositor Mecano 15 muestras con luz	150 kg	-	3 un	-

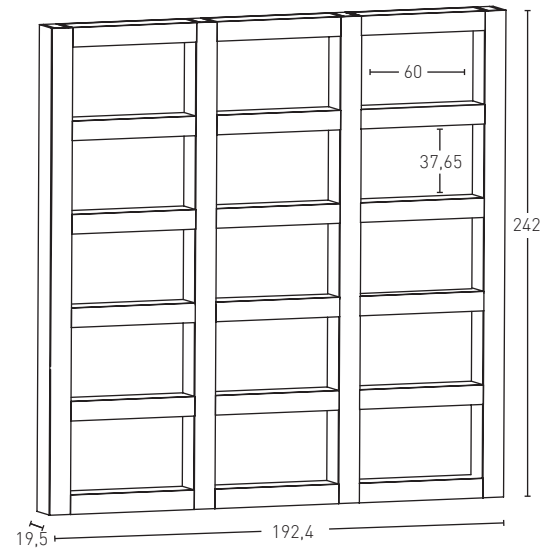

Marketing AMPLIACIÓN EXPOSITOR

EXPO-08

Expositor Mecano
+15 muestras con luz /
Exhibitor Mecano
+15 samples with lights

COD.	DESCRIPCIÓN DESCRIPTION	KG	CUB	M2	€ €/unidad
EXPO-08	Para expositores de más de 15 muestras, contactar con nuestro departamento comercial	-	-	-	-



Marketing EXPOSITOR MODULAR

EXPO-09

Expositor Modular 2 muestras /
Exhibitor Modular 2 samples

EXPO-10

Expositor Modular 4 muestras /
Exhibitor Modular 4 samples

EXPO-11

Expositor Modular 1 muestra /
Exhibitor Modular 1 sample

EXPO-12

Expositor Modular 2 muestras /
Exhibitor Modular 2 samples

COD.	DESCRIPCIÓN DESCRIPTION				€/unidad
EXPO-09	Expositor Modular 2 muestras	70 kg	-	3 un	-
EXPO-10	Expositor Modular 4 muestras	80 kg	-	3 un	-
EXPO-11	Expositor Modular 1 muestra	55 kg	-	3 un	-
EXPO-12	Expositor Modular 2 muestras	65 kg	-	3 un	-

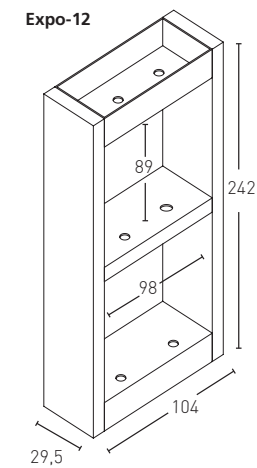
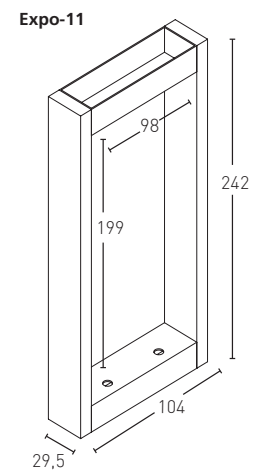
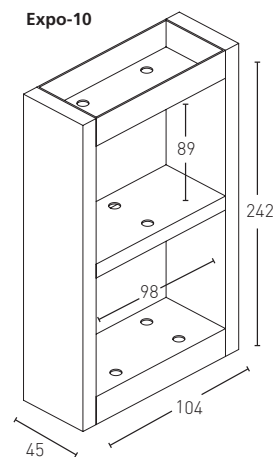
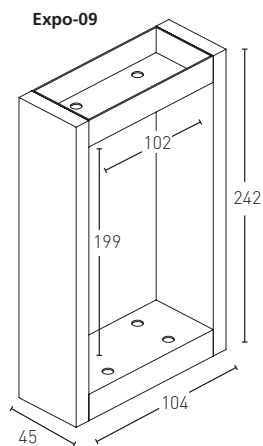

Marketing AMPLIACIÓN EXPOSITOR MODULAR

EXPO-13

Ampliación Expositor
muestras grandes /
Expansion of Exhibitor
big samples

COD.	DESCRIPCIÓN DESCRIPTION	KG	Caja	Módulo	€/unidad
EXPO-13	Para ampliaciones de expositores de muestras grandes, contactar con nuestro departamento comercial	-	-	-	-



Marketing EXPOSITOR VINILO

EXPO-17

Expositor Vinilo1 muestra /
Exhibitor Vinilo 1 sample

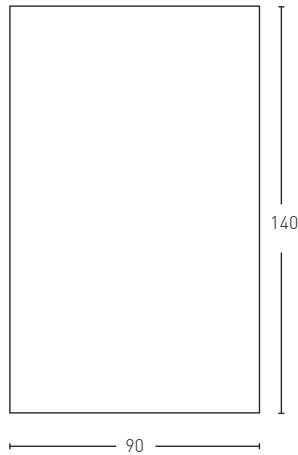

COD.	DESCRIPCIÓN DESCRIPTION	KG			€ €/unidad
EXPO-17 Forest	Vinilo de 140 cm x 90 cm	-	-	380 un	-
EXPO-17 Cement	Vinilo de 140 cm x 90 cm	-	-	380 un	-
EXPO-17 Vintage	Vinilo de 140 cm x 90 cm	-	-	380 un	-
EXPO-17 Brick	Vinilo de 140 cm x 90 cm	-	-	380 un	-
EXPO-17 Remember	Vinilo de 140 cm x 90 cm	-	-	380 un	-
EXPO-17 Lifestyle	Vinilo de 140 cm x 90 cm	-	-	380 un	-
EXPO-17 Classic	Vinilo de 140 cm x 90 cm	-	-	380 un	-

Expo-17 Forest



Expo-17 Cement



Expo-17 Vintage



Expo-17 Brick



Expo-17 Remember



Expo-17 Lifestyle



Expo-17 Classic



Marketing EXPOSITOR VINILO

EXPO-18

Expositor Vinilo /
Exhibitor Vinilo

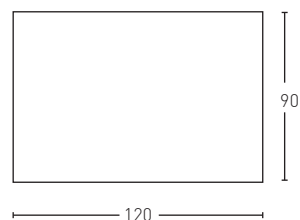

COD.	DESCRIPCIÓN DESCRIPTION	KG			€/unidad
EXPO-18 Forest	Vinilo de 120 cm x 90 cm	-	-	270 un	-
EXPO-18 Cement	Vinilo de 120 cm x 90 cm	-	-	270 un	-
EXPO-18 Vintage	Vinilo de 120 cm x 90 cm	-	-	270 un	-
EXPO-18 Brick	Vinilo de 120 cm x 90 cm	-	-	270 un	-
EXPO-18 Remember	Vinilo de 120 cm x 90 cm	-	-	270 un	-
EXPO-18 Lifestyle	Vinilo de 120 cm x 90 cm	-	-	270 un	-
EXPO-18 Classic	Vinilo de 120 cm x 90 cm	-	-	270 un	-

Expo-18 Forest



Expo-18 Cement

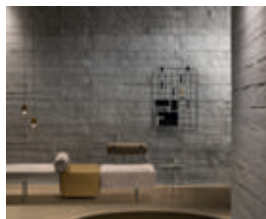

Expo-18 Vintage



Expo-18 Brick



Expo-18 Remember



Expo-18 Lifestyle



Expo-18 Classic

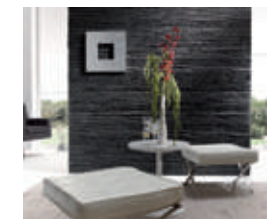



DATOS TÉCNICOS

Technical Specifications

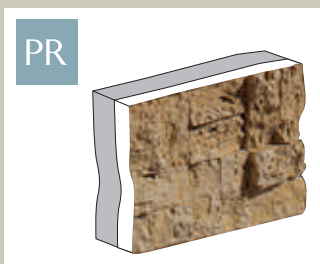

PANEL PR / 352-355



PANEL HD / 356-359



SEGURIDAD / 360



RECOMENDACIONES / 361



**PROYECTOS A MEDIDA
Y PARTNERS / 362**



PRODUCTO

Product

PANEL PR

Sistema de Paneles machihembrados tipo puzzle adecuados para revestimientos de paredes en el interior y en el exterior:

Descripción de la composición del Panel:

PRIMERA CAPA:

Es una capa entre 3-5 mm de hormigón polímero en base piedra denominada "PIEDRA" compuesta por una mezcla de 15% resina en peso con su correspondientes catalizadores y 85% de áridos (Carbonatos de Calcio, Dolomitas, Silicato, Alúminas, melaminas y aditivos ignifugantes)

SEGUNDA CAPA:

La segunda capa está compuesta por una inyección de espuma de poliuretano con celda abierta que proporciona al panel una buena absorción térmica y acústica denominada "POLIURETANO".

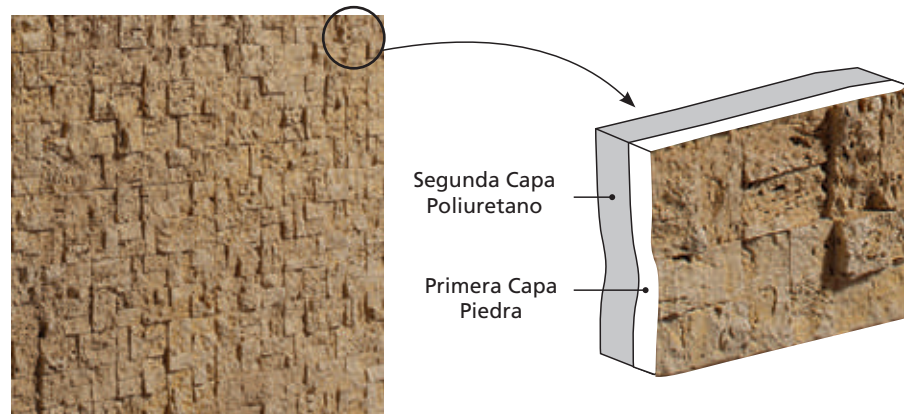

RECOMENDACIONES

En los acabados óxidos se desaconseja la utilización de productos químicos para su limpieza, al igual que se recomienda evitar cualquier técnica de frotado. Se trata de un efecto cuyo resultado final podría dañarse.



VENTAJAS

Advantages

Instalación en Interiores

Todo tipo construcciones y promociones: Viviendas, Locales Comerciales, Restaurantes, Hoteles, Cadenas de tiendas, Escaparates, Atrezos, Salones, Oficinas, etc.

Instalación en Exteriores

Todo tipo construcciones y promociones en el exterior: Fachadas, Terrazas.



APLICACIONES

Uses

Gran Calidad

Una de las cualidades fundamentales de PANELPIEDRA® es su gran calidad (sus texturas, colores, resistencias). Combinado con la creatividad de nuestros diseñadores y la innovación de nuestros ingenieros, nos permite la necesaria diferenciación que se requiere en el mercado para ser uno de los productos más competitivos del sector a nivel mundial.

Instalación

Es rápido y sencillo debido a su formato m², el panel es ligero manejable, sólo es necesaria una persona para su instalación y no requiere la mano de obra de un profesional para el montaje gracias a su sistema machihembrado. Este sistema de paneles permite que su instalación se realice en un tiempo muy pequeño sin necesidad de obra. (*Ver instrucciones de montaje*).

Acabado Perfecto

Su composición (piedra + poliuretano) unido al color realizado con óxidos de hierro, hace que su textura, su comportamiento en el tiempo y su apariencia sean perfectas.

Buen aislamiento térmico y acústico

Una de las capas del panel PANELPIEDRA® está compuesta por una inyección de poliuretano con celda abierta, este material, denominado "poliuretano" es uno de los mejores aislantes que existe en el mercado por sus propiedades de aislamiento y de absorción acústica. Todo ello hace que nuestro panel, una vez instalado, sea aislante térmico conservando durante más tiempo la temperatura y no dejando pasar ningún tipo de humedades ni bacterias. Siendo a su vez un sistema que mejora el aislamiento acústico global.

Importante ahorro en costes

Mantenimiento

No necesita mantenimiento.

Transporte

El poco peso del panel (6-7 Kg.) y su formato de m², son cualidades que facilitan su transporte, no siendo necesario un vehículo especial.

CARACTERÍSTICAS PANELES PR

PR

Densidades			
Densidad Aplicada en el Panel	UNE EN 1602	Kg. m3	700-800
Densidad Aplicada en Poliuretano	UNE EN 1602	Kg. m3	300-350
Reacción al Fuego y Resistencia Térmica			
Estabilidad Dimensional 24 Horas	-30° +90°	%Vol %Vol.	<0,5 <1
Reacción al Fuego	UNE EN 2327 EURO CLASE AS TM 84	CLASE CLASE CLASE	M-1 B S1 D0 B
Cof. de Conductividad Térmica 10°C Inicial	UNE EN 92202	W/m°C	0,022
Residuo de Calcinación	DIN 53395	%	0,9
Resistencia Mecánica			
Resistencia a la Tracción	ISO 527	MPa	97
Resistencia a Flexión	ISO 178	MPa	250
Módulo de Flexión	ISO 178	MPa	9750
Temp.de deformación Bajo Carga	ISO 75 A	°C	90
Dureza Shore	DIN53505	%	60
Rebote	DIN53573	%	50
Resistencia a la compresión	UNE EN 826	Kpa	200-250
10% Deformación			
Propiedades Dieléctricas			
Constante Di eléctrica 20°C	1000 Ciclos	----	2
Rigidez Di eléctrica 23°C	----	KV/cm	150-200
Factor de Potencia		%	0,02
Resistividad Eléctrica	1000 Ciclos	Ohnmios / cm	1,18 x10 ¹³
Resistencia al Exterior			
Resistencia a la Niebla Salina	Agua Cloruro Sódico 5,0 ± 0,5%	Temperatura 35° / -2	2.000 horas OK
Resistencia Cámara Acelerada	Luz Ultravioleta Temp. +50° / 3°	2000 Horas	No hay caleado No hay pérdida de brillo

INSTALACIÓN PANELES PR

PR



Atornillador con varias puntas para los tira fondos, sierra de corte eléctrica con cuchilla de madera, (para profesionales es recomendable una radial con disco de corte fino), pistola de cartuchos, metro, pincel para pintar, brocha para texturizar, regla, tacos, tirafondos, (para profesionales es recomendable una clavadora neumática) broca de 3mm y 8mm, masilla de juntas, y (masilla de pegado para instalaciones en el exterior), pintura, sprays y envejecidos.



Medimos la superficie a revestir y calculamos los paneles necesarios. Cada panel es aproximadamente un metro cuadrado.



Nos ayudamos con una regla para posteriormente señalar con un rotulador la superficie a cortar.



En el caso de paneles con dientes empezaremos cortando un extremo de la superficie por la línea que hemos trazado



Comprobaremos que el corte de los paneles se ha realizado correctamente.



Colocamos el panel sobre la pared y taladramos con broca de 3mm preferentemente en las juntas atravesando el panel hasta llegar a marcar la pared, donde mas tarde colocaremos el taco.



Es muy importante taladrar en lugares fáciles de disimular, realizaremos esta operación entre 4 y 6 veces por panel.



Retiramos el panel y posteriormente taladramos con broca de 6mm en los lugares que hemos marcado en la pared anteriormente con broca de 3mm.



Introducimos todos los tacos en la pared.



Realizaremos unos cordones con masilla de pegado en forma vertical en la parte trasera del panel. **ESTE PASO SÓLO SE UTILIZA SI LOS PANELES SON INSTALADOS EN EL EXTERIOR.**



Colocaremos el panel en la pared y uniremos los tornillos a los tirafondos, introduciendo los tornillos 2 ó 3mm en el panel, para poder disimularlo posteriormente con la masilla.



Ensamblamos panel con panel.

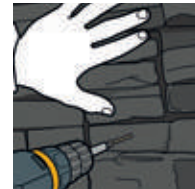

Seguimos realizando las mismas operaciones con todos los paneles, hasta cubrir toda la pared a revestir siempre introduciendo los tornillos en zonas fáciles de disimular.



Una vez revestida la superficie con paneles, rellenaremos con la masilla de juntas, tanto las juntas del ensamble como los agujeros realizados con el taladro.



Después de masillar, texturizaremos las juntas con un pincel fino y húmedo por las juntas y agujeros, con el fin de igualar la su textura.



Una vez texturizada la masilla esperaremos entre 2 y 4 horas para el siguiente paso.

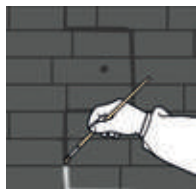

Transcurrido el tiempo de secado de la masilla, con diferentes pinceles procedemos a pintar las zonas donde hemos introducido la masilla.



La función del spray es la de igualar el color de las juntas al panel, para ello una vez seca la pintura anterior, aplicaremos a 40 Cm de los paneles con el spray envejecido un Flash.



Seguidamente sin dejar secar la pintura pasaremos un trapo mojado con el fin de que el envejecimiento se fije en los poros del panel, esta operación se puede repetir tantas veces sea necesario.



Una vez realizado todos los procesos el resultado es un acabado perfecto.

Notas importantes en la instalación:

- Para un corte fino y rápido de los paneles, si se dispone de una amoladora o bien una rectificadora con disco fino, es aconsejable sustituir por la sierra eléctrica.
- Para una colocación rápida, en vez de atornillar, se puede utilizar una clavadora neumática de carpintero.
- Es importante respetar los tiempos de secado de las pinturas y masillas.
- Siempre que se aplique envejecidos realizarlos a 40 cm del panel, aplicando un pequeño flash e inmediatamente frotando con un trapo mojado con agua.
- Existen videos de montaje y instrucciones específicas de instalación.



PRODUCTO

Product

PANEL HD

Sistema de paneles machihembrados tipo puzzle adecuados para revestimientos de paredes en el interior y en el exterior:

Descripción de la composición del Panel:

Es una mezcla de diferentes áridos que forman un hormigón polímero en base piedra denominada "PIEDRA" compuesta por una mezcla de 15% de diferentes tipos de resinas porcentaje en peso con sus correspondientes catalizadores y 85% de áridos (Carbonatos de Calcio, Dolomitas, Silicato, Alúminas, melaminas y aditivos ignifugantes).

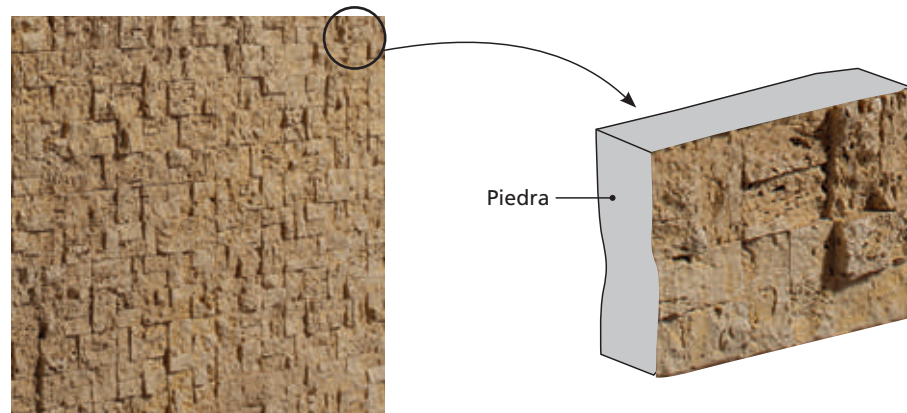

RECOMENDACIONES

En los acabados óxidos se desaconseja la utilización de productos químicos para su limpieza, al igual que se recomienda evitar cualquier técnica de frotado. Se trata de un efecto cuyo resultado final podría dañarse.



VENTAJAS

Advantages

Los paneles son muy solicitados por Arquitectos, Decoradores, Diseñadores, Promotores, Constructores, Centros de Bricolajes, Comercios de Decoración, etc.

Instalación en Interiores

Todo tipo construcciones y promociones: Viviendas, Locales Comerciales, Restaurantes, Hoteles, Cadenas de tiendas, Escaparates, Atrezos, Salones, Oficinas, etc.

Instalación en Exteriores

Todo tipo construcciones y promociones en el exterior: Fachadas, Terrazas.



APLICACIONES

Uses

Gran Calidad

Una de las cualidades fundamentales de PANELPIEDRA® es su gran calidad (sus texturas, colores, resistencias). Combinado con la creatividad de nuestros diseñadores y la innovación de nuestros ingenieros, nos permiten la necesaria diferenciación que se requiere en el mercado, y ser uno de los productos más competitivos del sector a nivel mundial.

Instalación

Es rápido y sencillo debido a su formato m², el panel es ligero manejable, sólo es necesaria una persona para su instalación y no requiere la mano de obra de un profesional para el montaje gracias a su sistema machihembrado. Este sistema de paneles permite que su instalación se realice en un tiempo muy pequeño sin necesidad de obra. (*Ver instrucciones de montaje*).

Acabado Perfecto

Su composición (piedra) unido al color realizado con óxidos de hierro, hace que su textura, su comportamiento en el tiempo y su apariencia sean perfectas.

Gran Resistencia

El producto está compuesto por una mezcla de áridos que le confieren una gran resistencia al impacto, al fuego y a todas las inclemencias del tiempo, siendo muy utilizado en lugares públicos, como hoteles, museos y espacios con alto tránsito de personas.

Mantenimiento

No necesita mantenimiento.

Transporte

El poco peso del panel (15-20 Kg.) y su formato de 0,85-1,00 de m² (aprox.) son cualidades que facilitan su transporte, no siendo necesario un vehículo especial.

CARACTERÍSTICAS PANELES HD

HD

Dilatación, Contracción			
Absorción del Agua	UNE EN ISO 10545 - 3	%	0,3
Dilatación Térmica Lineal	UNE EN ISO 10545 - 8	--	2,6 x 10 ⁻⁸ °C
Reacción al Fuego y Resistencia Térmica			
Estabilidad Dimensional	-30°	%Vol	<0,5
24 Horas	+200°	%Vol.	<1
Reacción al fuego	UNE EN 2327 EURO CLASE AS TM 84	CLASE CLASE CLASE	M-1 B S0 D0 A
Cof. de Conductividad Térmica 10°C Inicial	UNE EN 92202	W/m°C	0,019
Residuo de Calcinación	DIN 53395	%	0,7
Resistencia Mecánica			
Resistencia al desgaste por rozamiento	UNE EN 1341	Anchura de Huella 17, 5	
Resistencia a Flexión	UNE EN ISO 10545-4	22,3N/mm ²	
Resistencia a la Carga de Rotura	UNE EN ISO 10545-4	3929,6N	
Resistencia al impacto	UNE 127020		
	Esfera de 400gr. y ø46mm	Huella a 500mm. Rotura 600mm	
	Esfera de 1000gr. y ø55mm	Huella a 200mm Rotura 300mm	
	Esfera de 1000gr. y ø66mm	Huella a 200mm Rotura 300mm	
	UNE EN 826		
Resistencias Químicas			
Resistencia Cloruro de Amonio y sales	UNE EN ISO 10545-13	Ligera decoloración no visible	
Ácido Clorhídrico 3%	UNE EN ISO 10545-13	Ligera decoloración	
Ácido Cítrico	UNE EN ISO 10545-13	Decoloración y cambio de textura	
Hidróxido potásico (100gl)	UNE EN ISO 10545-13	Decoloración	
Resistencia al Exterior			
Resistencia al choque térmico	UNE EN ISO 10545-9 5,0 ± 0,5%	Temperatura 40° / -2	2.000 horas OK
Resistencia Cámara Acelerada	Luz Ultravioleta Temp. +50° / 3°	2.000 Horas	No hay caleado No hay pérdida de brillo

INSTALACIÓN PANELES HD

HD



Atornillador con varias puntas para los tirafondos, sierra de corte eléctrica con cuchilla de madera, (para profesionales es recomendable una radial con disco de corte de piedra), pistola de cartuchos, metro, pincel para pintar, brocha para texturizar, regla, tacos, tirafondos, (para profesionales es recomendable una clavadora neumática) broca de 3mm y 8mm, masilla de juntas, y (masilla de pegado para instalaciones en el exterior), pintura, sprays y envejecidos.



Medimos la superficie a revestir y calculamos los paneles necesarios. Cada panel es aproximadamente un metro cuadrado.



Nos ayudamos con una regla para posteriormente señalar con un rotulador la superficie a cortar.



En el caso de paneles con dientes empezaremos cortando con una radial un extremo de la superficie por la línea que hemos trazado



Comprobaremos que el corte de los paneles se ha realizado correctamente.



Colocamos el panel sobre la pared y taladramos con broca de 3mm. preferentemente en las juntas, atravesando el panel hasta llegar a marcar la pared, donde más tarde colocaremos el taco.



Es muy importante taladrar en lugares fáciles de disimular, realizaremos esta operación entre 4 y 6 veces por panel.



Retiramos el panel y posteriormente taladramos con broca de 6mm en los lugares que hemos marcado en la pared anteriormente con broca de 3mm.



Introducimos todos los tacos en la pared.



Realizaremos unos cordones con masilla de pegado en forma vertical en la parte trasera del panel. **ESTE PASO SÓLO SE UTILIZA SI LOS PANELES SON INSTALADOS EN EL EXTERIOR.**



Colocaremos el panel en la pared y unimos los tornillos a los tirafondos, introduciendo los tornillos 2 ó 3mm en el panel, para poder disimularlo posteriormente con la masilla.



Ensamblamos panel con panel.

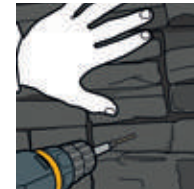

Seguimos realizando las mismas operaciones con todos los paneles, hasta cubrir toda la pared a revestir, siempre introduciendo los tornillos en zonas fáciles de disimular.



Una vez revestida la superficie con paneles, rellenaremos con la masilla de juntas, tanto las juntas del ensamblaje como los agujeros realizados con el taladro.



Después de masillar, texturizaremos las juntas y agujeros con un pincel fino y húmedo con el fin de igualar la textura.



Una vez texturizada la masilla, esperaremos entre 2 y 4 horas para el siguiente paso.

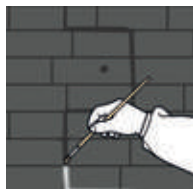

Transcurrido el tiempo de secado de la masilla, con diferentes pinceles procedemos a pintar las zonas donde hemos introducido la masilla.



La función del spray es la de igualar el color de las juntas al panel, para ello una vez seca la pintura anterior, aplicaremos a 40 Cm de los paneles con el spray envejecido un Flash.



Seguidamente, sin dejar secar la pintura, pasaremos un trapo mojado con el fin de que el envejecimiento se fije en los poros del panel, esta operación se puede repetir tantas veces sea necesario.



Una vez realizados todos los procesos el resultado es un acabado perfecto.

Notas importantes en la instalación:

- Para un corte fino y rápido de los paneles, si se dispone de una amoladora o bien una rectificadora con disco fino, es aconsejable sustituir por la sierra eléctrica.
- Para una colocación rápida, en lugar de atornillar, se puede utilizar una clavadora neumática de carpintero.
- Es importante respetar los tiempos de secado de las pinturas y masillas.
- Siempre que se aplique envejecidos realizarlos a 40 cm del panel, aplicando un pequeño flash e inmediatamente frotando con un trapo mojado con agua.
- Existen videos de montaje e instrucciones específicas de instalación.

SEGURIDAD

Security

Sobre el producto



Limpieza del Producto

Como norma general, el mejor producto para la limpieza es el agua. Una limpieza con agua abundante permite eliminar el posible polvo. En el caso de tener la necesidad de desinfectar alguna zona, usar jabones con pH neutro.

No se deben utilizar productos químicos agresivos como la lejía, desengrasantes de base ácida, amoniacos, desincrustantes de cal, etc. Estos productos reaccionan con los carbonatos de la piedra creando problemas de eflorescencias (manchas blancas en los paneles).

Solamente son aconsejables si su aplicación es de manera muy diluida y realizando pruebas de comportamiento del producto.

No se recomienda la utilización de productos de limpieza aceitosos y agresivos.



Forma de Suministro

Los paneles y complementos se suministran en cajas de cartón y palés de madera tratados (*Ver apartado tarifa técnica para saber cantidad por caja y palé*) no retornables, siendo la responsabilidad del embalaje del poseedor final. Según La Ley 11/79 (Artículo 18.1 de Reglamentos).



El Transporte

Producto no peligroso para su transporte por carretera, ferrocarril o vía marítima.



Información medioambiental

No es perjudicial para la salud (si no es ingerido) ni tampoco para el medio ambiente, el panel está compuesto en un 75% por material reciclable formado por áridos sobrantes de canteras.

RECOMENDACIONES

Recommendations

Recomendaciones de Almacenamiento

Los paneles deben estar y conservarse en un almacén bajo techo, tal como se envían de fábrica, dentro de sus cajas, en un lugar plano y horizontalmente. Almacenar a una temperatura entre 5° - 45°.

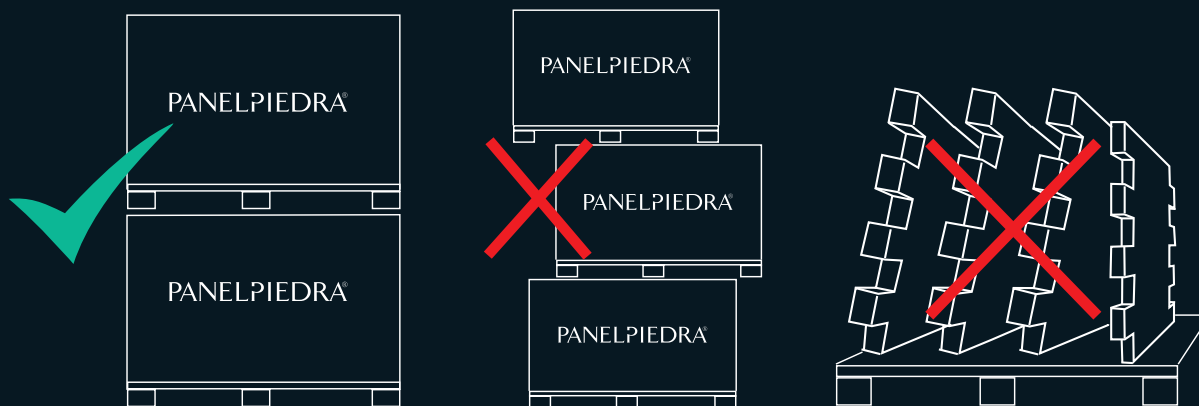

Recomendaciones de Manipulación

Durante la instalación evite, en la medida de lo posible, generar polvo y esparcirlo en el aire, utilice aparatos de absorción y aspiración para su recogida y posterior eliminación. Después de una instalación, recoger todo el producto de desperdicio y lavar con agua la zona y los materiales implicados, con el fin de ser respetuoso con el medio ambiente.

Recomendaciones Relativas a la Eliminación

Se debe evitar o minimizar la generación de desechos en la medida de lo posible. Elimine el sobrante por medio de empresas especializadas. La eliminación de este producto debe cumplir siempre con los requisitos de la legislación de protección del medio ambiente y la eliminación de desechos, así como todos los requisitos propios de las autoridades locales. Evite su dispersión en desguaces y alcantarillas.

PROYECTOS A MEDIDA

Bespoke products

Para cualquier proyecto, obra, decoración... estamos contigo en la fabricación y preparación para tus necesidades de todos nuestros paneles.

Adaptamos nuestros modelos a cualquier proyecto o medida. Con la misma calidad y los materiales de primera que nos caracterizan. Ajustamos medidas, colores, etc. Queremos ayudarte a transformar los espacios fácilmente y con menor coste para tus clientes.

Disponemos de una amplia red comercial a tu servicio por todo el mundo.

Visita nuestra web www.panelpiedra.com

For any project, we are here to support you with bespoke panels.

We can adapt our models to any project, always with the same quality and materials. We can modify sizes, colours, models, etc. We want to support our clients in order to easily transform spaces. Always with simple installation and low costs.

We have an extensive commercial network working for you in world.

Visit our website www.panelpiedra.com



PARTNERS

Gracias a todos por vuestra confianza y esperamos poder seguir creciendo con nuevos clientes y partners EN CADA RINCÓN DEL MUNDO.

Thank you all for your trust and we hope to continue to grow with new customers and partners IN EVERY CORNER OF THE WORLD.



